

HAMILTON GRANGE

Manhattan Sites



HISTORIC STRUCTURE REPORT
HAMILTON GRANGE NATIONAL MEMORIAL

Manhattan Sites

New York City

Historical Data Section

by

Alfred Mongin

Architectural Data Section

by

Anne D. Whidden

North Atlantic Historic Preservation Center
North Atlantic Region, National Park Service
U.S. Department of the Interior
Boston, Massachusetts

1980



FOREWORD

It is the intent of the National Park Service to restore the Grange as much as practicable to its appearance in 1802-1804, the years of Alexander Hamilton's occupancy. This stems from the fact that Congress authorized the Secretary of the Interior to accept the donation of the Grange in 1962 for the purpose of creating a memorial to commemorate the role played by Hamilton in the establishment of the nation. Therefore, the term historic -- when applied to elements of the Grange -- refers to elements in place 1802-1804.

* * *

The Historical Data Section of this report is designed to relate, and to document, the story of the construction of the Grange in 1802, and to chronicle alterations to the structure from 1802 to the present. To do this it has been necessary to relate in some detail the lives of those who have occupied the house during these past 18 decades, for it was to fulfill the needs of these people that the house was built. It stands today as a product of the life and times to which it has been witness.

The Architectural Data Section of the report presents the results of a detailed physical examination of Hamilton Grange. It assesses the origin and condition of each extant architectural element, and compares its present configuration to the historic one. Finally, it describes what actions should be taken in order to return the Grange to its appearance during its historic period.

* * *

This Historic Structure Report was written for the North Atlantic Region of the National Park Service; it was compiled under the direction of the North Atlantic Historic Preservation Center. The Preservation Center is part of the Division of Planning and Resource Preservation, North Atlantic Region. It is equipped with laboratories and analytical equipment, and staffed by Historic Preservation Conservators and Exhibit Specialists who provide technical support to parks primarily within the North Atlantic Region. The report presented here was organized, edited, and updated by Preservation Center employee Sharon K. Ofenstein.

TABLE OF CONTENTS

<u>FOREWORD</u>	ii
<u>TABLE OF CONTENTS</u>	iii
<u>ADMINISTRATIVE DATA</u>	viii
<u>KEY TO ABBREVIATIONS</u>	ix
<u>LIST OF ILLUSTRATIONS AND CREDITS</u>	x
<u>HISTORICAL DATA SECTION</u>	1
I. INTRODUCTION	2
II. ORIGINAL SITE SELECTION	4
III. DESIGN	15
IV. CONSTRUCTION	27
V. LIFE AT THE GRANGE	41
VI. THE ESTATE OF ALEXANDER HAMILTON	54
VII. RELOCATION OF THE GRANGE	71
VIII. PRESERVATION EFFORTS	79
<u>ARCHITECTURAL DATA SECTION</u>	85
I. INTRODUCTION	86
A. <u>Geographical Summary</u>	87
B. <u>Historical Summary</u>	88
C. <u>Architectural Summary</u>	90
Original Appearance	90
Design	90
Condition	91

II.	EXISTING CONDITIONS: EXTERIOR	93
A.	<u>Introduction</u>	94
B.	<u>Roofs and Balustrades</u>	95
	Main Roof	95
	Piazza and Portico Roofs	96
	Balustrades	98
C.	<u>Chimneys</u>	100
	Operative Stacks	100
	Inoperative Stacks	100
D.	<u>Entablatures and Gutter Systems</u>	101
	Entablatures	101
	Gutters	101
	Leaders (Downspouts)	102
E.	<u>Siding and Trim</u>	104
	Flush Boards	104
	Clapboards	104
	Trim Boards	105
	Sheathing	105
F.	<u>Foundation</u>	106
G.	<u>Porches</u>	107
	Piazas	107
	Portico	108
	Piers	109
H.	<u>Windows</u>	110
	Surrounds	110
	Sash	110
	Hardware	111
I.	<u>Shutters</u>	112
	Types	112
	Hardware	113
J.	<u>Exterior Doorways</u>	116
	Main Entrance	116
	Side Entrance	116
	Basement Entrances	116

III.	EXISTING CONDITIONS: INTERIOR	119
A.	<u>Synopsis of Original Elements</u>	120
	Framing	120
	Insulation	121
	Lath and Plasterwork	121
	Millwork	122
	Floors	122
	Fireplaces and Mantels	123
	Stairs	124
	Doorways and Doors	125
	Windows	126
	Interior Fixtures	126
B.	<u>Basement Analysis</u>	128
	Basement	128
	Subbasement	129
	Original Cellar	129
C.	<u>Room-by-Room Analysis: First Floor</u>	131
	Entry and Stair Halls	131
	Southeast Room	135
	West Octagon Room	136
	East Octagon Room	138
	Northwest Room	140
	North Hall	141
	Northeast Room	143
D.	<u>Room-by-Room Analysis: Second Floor</u>	145
	Southwest Room	145
	Front Hall	146
	Southeast Room	149
	Center Hall	150
	West Center Room	151
	East Center Room	152
	North Rooms	154
E.	<u>Attic Analysis</u>	157
F.	<u>Mechanical Systems Analysis</u>	158
	Heating and Cooling	158
	Water and Sewer	158
	Electricity	159
	Security	159

IV.	FINISHES ANALYSIS	161
A.	<u>Exterior Finishes</u>	162
	Introduction	162
	Methodology	163
	Siding	163
	Trim	165
	Porch Floors	166
	Porch Roofs	167
	Chimneys	168
B.	<u>Interior Finishes</u>	169
	Introduction	169
	General Patterns	169
	Walls	170
	Woodwork	173
	Window Panels	178
	Cornices	178
	Ceilings	179
	Floors	179
	Individual Rooms	179
	Related Information	182
	Suggested Restoration Finishes	182
V.	RECOMMENDATIONS	185
A.	<u>Definition of Historical Period</u>	186
B.	<u>Summary of Recent Work</u>	187
C.	<u>Phase I: Stabilization</u>	188
	Exterior	188
	Interior	189
D.	<u>Phase II: Relocation and Restoration</u>	190
	Site Selection and Moving Operation	190
	Exterior Restoration	191
	Interior Restoration	196
	Mechanical Systems	204
E.	<u>Alternative Phase II</u>	205
	Exterior Restoration	205
	Interior Restoration	205

VI.	BIBLIOGRAPHY	206
VII.	APPENDICES	216
	A. Chronology of Construction and Physical Change	
	B. Letter from Philip Schuyler to Elizabeth Hamilton	
	C. Last Will and Testament of Alexander Hamilton	
	D. Trustees of, and Subscribers to, the Hamilton Estate Consortium	
	E. Appraisal of the Grange, November 10, 1933	
	F. Hamilton Grange: Measured Drawings, City Architects' Emergency Committee, March 2, 1933	
	G. Hamilton Grange: Details of Interior Design Rendered for the Index of American Design, 1930's	
	H. Hamilton Grange: Field Notebook for the Index of American Design, 1930's	
	I. Hamilton Grange: Measured Drawings, G.R.W. Watland, 1964	
	J. Hamilton Grange: Measured Drawings, Newton P. Bevin, 1964	
	K. Restoration of Hamilton Grange, Phase I, 1978-1979	
	L. Excerpts from <u>Feasibility Study for Moving and Restoring Hamilton Grange National Memorial</u> , Meadows/Woll Architects, 1980	
	M. Molding Profile Analysis	
	N. Hardware Analysis	
	O. Nail Analysis	
	P. Mortar and Plaster Analysis	
	Q. Other Sources Investigated	

ADMINISTRATIVE DATA

The Historical Data Section report is authorized by memorandum, file H2215-RHA, dated May 13, 1964, from Regional Director, Northeast Region, to Superintendent, New York City National Park Service Group, subject: Research Needed for Hamilton Grange and Bill of Rights Room Exhibits; and by memorandum, file H30-RHA, dated July 15, 1964, from Acting Regional Director Palmer, Northeast Region, to Superintendent, New York City National Park Service Group, subject: Historic Structure Report, Part II, Hamilton Grange, Historical Data Section.

Research for this paper was conducted principally in the Library of Congress — under a research grant from the American Scenic and Historic Preservation Society — in the New York Public Library, and at the New-York Historical Society. Consultation and guidance at many stages of the work were received gratefully from Dr. Thomas M. Pitkin, retired Supervisory Historian, New York City National Park Service Group; Alexander Hamilton, President, American Scenic and Historic Preservation Society and a great-great grandson of the Alexander Hamilton who built the Grange; Professor James G. VanDerpool, Executive Secretary, New York City Landmarks Preservation Commission; Miss Betty Ezequelle, New-York Historical Society; Gardner Osborn, Executive Secretary, American Scenic and Historic Preservation Society; Newton P. Bevin, A.I.A., Consulting Architect for the Grange restoration; Charles G. Dorman, Museum Curator, Independence National Historical Park; and Mrs. Viola Thomas, Administrative Assistant to Mr. Hamilton. Many other persons gave substantial assistance as well.

The Architectural Data Section draws upon the Historic Data Section's research; on additional research into the architectural design and construction of buildings contemporaneous with the Grange (especially those located in New York City or designed by John McComb, Jr.); on the architectural investigations conducted in 1964 for the National Park Service by NPS Historical Architect Henry A. Judd and Consulting Architect Newton P. Bevin, A.I.A.; and on additional architectural investigation performed in 1977-1980.

KEY TO ABBREVIATIONS

<u>Abbreviation</u>	<u>For</u>
AH	Alexander Hamilton
AHCB	Alexander Hamilton Cash Books
AHP/BNY	Alexander Hamilton Papers, Bank of New York, New York City
AHP/LC	Alexander Hamilton Papers, Library of Congress, Washington, D.C.
AL	Avery Architectural Library, Columbia University
AS&HPS	American Scenic and Historic Preservation Society, New York City
BNY	Bank of New York, New York City
EH	Elizabeth Hamilton
LC	Library of Congress, Washington, D.C.
MCNY	Museum of the City of New York, New York City
NYCR	New York County Registrar, New York City, New York
N-YHS	New-York Historical Society
PAHPP	Papers of Alexander Hamilton Publication Project, Butler Library, Columbia University
<u>S&HA</u>	<u>Scenic and Historic America</u>

LIST OF ILLUSTRATIONS AND CREDITS

1. The Grange Property, August 2, 1800. Reproduced from Bolton, Washington Heights Manhattan.
2. Plat of the First Section of Grange Property, c. August 1800. Drawing attributed to Edward H. Hall, after a plat map in Liber 218, between pp. 224-225, New York County Registrar's Office. Courtesy the American Scenic and Historic Preservation Society.
3. Topographical Map of the Grange Vicinity, before 1600. Reproduced from Bolton, Washington Heights Manhattan.
4. Subdivision Plan of the Grange Vicinity, 1658-1712. Reproduced from Bolton, Washington Heights Manhattan.
5. Bill for Renovation of Farmhouse on Grange Property, from John McComb, Jr. Courtesy the Alexander Hamilton Papers, Library of Congress.
6. Influences on the Grange Design: The Schuyler Mansion, Albany, N.Y., 1761, hexagonal vestibule added 1815. Reproduced from Schuyler Mansion, A Historic Structure Report, courtesy the New York State Office of Parks and Recreation, Division for Historic Preservation, Bureau of Historic Sites. Existing-conditions drawing by Charles E. Barthe, Jr.
7. Influences on the Grange Design: Main Stair of the Morris-Jumel Mansion, before redecoration. Photograph by L.H. Frohman. Courtesy the Washington Headquarters Association, New York City.
8. Influences on the Grange Design: Octagonal Drawing Room of the Morris-Jumel Mansion. Photograph by Robert Emmett Bright. Courtesy of Architectural Digest. Copyright © 1977 Knapp Communications Corporation.
9. Influences on the Grange Design: Plan for Government House, New York City, by John McComb, Jr., 1790. McComb drawing no. 58a, courtesy the New-York Historical Society.
10. Influences on the Grange: Plan for a Country House, by John McComb, Jr., c. 1799. McComb drawing no. 109, courtesy the New-York Historical Society.
11. Sources of the Grange Design: Plan of the Left-Hand Terminal Pavilion, Kedleston Hall, Derbyshire. James Paine, Plans, Sections, and Elevations of Noblemen and Gentlemen's Houses, II, 1793. Courtesy the Avery Library, Columbia University.
12. Conjectural Re-creation of the Grange's Original Second-Floor Plan. Drawing by James G. VanDerpool, in "A Restoration Problem at Hamilton Grange," Columbia Library Columns, February 1955. Courtesy Columbia University Library.

13. Conjectural Re-creation of the Grange's Original First-Floor Plan. Drawing by James G. VanDerpool, in "A Restoration Problem at Hamilton Grange," Columbia Library Columns, February 1955. Courtesy Columbia University Library.
14. The Grange: Second-Floor North Hall, Cornice Continuing through Partition. NPS photograph by Jack E. Boucher, 1964.
15. The Grange: Basement and First-Floor Renovation and Alteration Plans, December 3, 1888. Courtesy the Department of Buildings, City of New York.
16. Sources of the Grange Design: Doorway Fanlight. William Paine, The Practical House Carpenter, 1794. Courtesy the Henry Francis duPont Winterthur Museum, Winterthur, Delaware.
17. Post-Grange Designs by John McComb, Jr.: Alexander Hall, Princeton Theological Seminary, Princeton, New Jersey, 1815-1817. Photograph by Damie Stillman, reproduced by permission.
18. The Grange: Window Treatment, "Second-Best" Rooms. NPS photograph by Jack E. Boucher, 1962.
19. The Grange: Original Mantel, West Center Room. NPS photograph, 1964.
20. The Grange: Original Mantel, Second-Floor Northwest Room. NPS photograph by Jack E. Boucher, 1964.
21. The Grange: Replacement Mantel, West Octagon Room. NPS photograph by Jack E. Boucher, 1964.
22. Original Mantel, Gracie Mansion, New York City, c. 1799. NPS photograph by Adolph Studley, Inc., New York City, 1955.
23. The Grange: Investigation of Fireplace, First-Floor Northeast Room. NPS photograph, 1964.
24. The Grange and Its Outbuildings, 1819, with Present Location and Street Plan Superimposed. Courtesy the American Scenic and Historic Preservation Society.
25. The Grange and Its Outbuildings, c. 1804, with Present Location and Street Plan Superimposed. Drawing by Edward H. Hall, Seventeenth Annual Report (1912), American Scenic and Historic Preservation Society. Courtesy the American Scenic and Historic Preservation Society.
26. Statement of Account and Receipt, Ezra Weeks to Alexander Hamilton, July 3 and 16, 1803. Courtesy the Alexander Hamilton Papers, Library of Congress.
27. Statement of Account, John McComb, Jr., to Alexander Hamilton, December 8, 1802. Courtesy the Alexander Hamilton Papers, Library of Congress.
28. "Final Account...", John McComb, Jr., to Alexander Hamilton (three sheets). Courtesy the Alexander Hamilton Papers, Library of Congress.

29. The Grange, 1802. Unsigned conjectural drawing, c. 1933. Courtesy the American Scenic and Historic Preservation Society.
30. The Grange: South Elevation and First-Floor Plan, 1802. Unsigned conjectural drawing, c. 1933. Courtesy the American Scenic and Historic Preservation Society.
31. The Grange: East Elevation and Second-Floor Plan, 1802. Unsigned conjectural drawing, c. 1933. Courtesy the American Scenic and Historic Preservation Society.
32. The Grange Vicinity, 1850. H.A. Jones, C.E., "Map of that Part of the City and County of New-York North of 50th Street" (the "Dripps Map"). Published by M. Dripps, 1851. Reproduced from Stokes, The Iconography of Manhattan Island, Vol. III.
33. The Grange: South Elevation, c. 1864. Courtesy the American Scenic and Historic Preservation Society.
34. The Grange: South and West Elevations, before 1876. Courtesy of Mrs. William G. Chipley, New York City (a great-granddaughter of William G. Ward).
35. The Grange: North and West Elevations, before 1876. Courtesy the New-York Historical Society and Mrs. William G. Chipley.
36. The Grange: North and East Elevations, before 1888. Courtesy the American Scenic and Historic Preservation Society.
37. The Grange: Replacement Mantel, First-Floor Northeast Room. Photograph by L.D. Thornton, 1955. Courtesy the American Scenic and Historic Preservation Society.
38. The Grange: South and East Elevations, with Grove of Gum Trees, c. 1884-1888. Attributed to an artotype by E. Bierstadt, New York. Courtesy the Museum of the City of New York.
39. The Grange: South and West Elevations, c. 1888. Courtesy the Museum of the City of New York.
40. The Grange: Relocation Plan, 1888. Courtesy the Department of Buildings, City of New York.
41. The Grange: Basement and First-Floor Renovation and Alteration Plans, December 3, 1888. Courtesy the Department of Buildings, City of New York.
42. The Grange: Second-Floor Renovation and Alteration Plan, December 3, 1888. Courtesy the Department of Buildings, City of New York.
43. The Grange: Just Prior to Moving, 1889. Courtesy the Museum of the City of New York.

44. The Grange: Just After Moving, spring 1889. Courtesy the New-York Historical Society.
45. The Grange: West Elevation, Relocated Main Entrance. Photograph by L.D. Thornton, 1955. Courtesy the American Scenic and Historic Preservation Society.
46. The Grange: Interior View of Relocated Main Entrance. Courtesy the Museum of the City of New York.
47. The Grange: After Relocation, 1889 (view southeastward from original to relocation sites). Courtesy the New-York Historical Society.
48. The Grange: West Elevation with Relocated Entry Portico, 1889. Courtesy the New-York Historical Society.
49. The Grange: West and North Elevations, c. 1889-1890. Photograph by Thomas G. Pratt for John H. Morrison. Courtesy the American Scenic and Historic Preservation Society.
50. The Grange: First-Floor Plan Showing 1889 Alterations. Drawing by James G. VanDerpool, in "A Restoration Problem at Hamilton Grange," Columbia Library Columns, February 1955. Courtesy Columbia University Library.
51. The Grange: West End of Present Entry Hall. Photograph by L.D. Thornton, 1955. Courtesy the American Scenic and Historic Preservation Society.
52. The Grange: East End of Present Entry Hall, c. 1889-1892. Courtesy the New-York Historical Society.
53. The Grange: Present Main Stair. Photograph by L.D. Thornton, 1955. Courtesy the American Scenic and Historic Preservation Society.
54. The Grange: Location of Original Rear Doorway, First-Floor North Hall. NPS photograph by Jack E. Boucher, 1964.
55. The Grange: Center and Front Halls, Second Floor, Showing Present Location of Attic Stair. NPS photograph by Jack E. Boucher, 1962.
56. The Grange: Eastward View of Octagonal Rooms in Use as Saint Luke's Church, c. 1889-1892. Reproduced from Tuttle, History of Saint Luke's Church in the City of New York 1820-1920. Courtesy of Saint Luke's Church.
57. The Grange and Construction of Saint Luke's Church, c. 1892. Reproduced from The Illustrated American, April 23, 1892.
58. The Grange and Completed Saint Luke's Church, c. 1894. Courtesy the American Scenic and Historic Preservation Society.
59. The Grange and Completed Saint Luke's Church, c. 1893 (view southeastward from original to relocation sites). Courtesy the New-York Historical Society.

60. The Grange: West Octagon Room in Use as Rectory Drawing Room, c. 1892. Photograph by E.S. Bennett. Courtesy the New-York Historical Society.
61. The Grange: East End of Entry Hall, c. 1892-1909. Courtesy the American Scenic and Historic Preservation Society.
62. The Grange: North and West Elevations, Showing Location of Original Rear Door. Newspaper photograph captioned "Hamilton Grange, New York, June 1897." Courtesy the Museum of the City of New York.
63. The Grange: South Elevation, c. 1903. Pierce, New Harlem Past and Present.
64. The Grange: North and West Elevations, c. 1909-1912. Tuttle, History of Saint Luke's Church in the City of New York 1820-1920. Courtesy Saint Luke's Church.
65. The Grange: Side Door, Exterior View. NPS photograph.
66. The Grange: Side Door, Interior View. NPS photograph by Jack E. Boucher, 1964.
67. The Grange: North and West Elevations, 1912. Photograph by Edward H. Hall, Seventeenth Annual Report (1912), American Scenic and Historic Preservation Society. Courtesy the American Scenic and Historic Preservation Society.
68. The Grange Neighborhood, c. 1920. Tuttle, History of Saint Luke's Church in the City of New York 1820-1920. Courtesy Saint Luke's Church.
69. The Grange: West Elevation and Adjacent Apartment Building. NPS photograph by Jack E. Boucher, 1964.
70. The Grange: East Elevation and Adjacent Buildings. Photograph by L.D. Thornton, 1955. Courtesy the American Scenic and Historic Preservation Society.
71. The Grange: East End of Entry Hall, Apse, and East Octagon Room, probably 1924-1933. Courtesy the American Scenic and Historic Preservation Society.
72. The Grange: Plan of First and Second Floors. Drawing by Edward H. Hall, 1925. Courtesy the American Scenic and Historic Preservation Society.
73. The Grange: Plans of Basement, First, and Second Floors, c. 1925-1930 (three sheets: mixture of original, later, and conjectural elements). Courtesy the American Scenic and Historic Preservation Society.
74. The Grange: Plans of Cellar, Basement, First, and Second Floors. Measured drawings by A.D. Anstey, 1932 (four sheets). Courtesy the American Scenic and Historic Preservation Society.
75. The Grange: West Elevation After 1933 Painting. Courtesy the American Scenic and Historic Preservation Society.
76. Partridge Statue of Alexander Hamilton Being Removed from Original Location. Reproduced from the Brooklyn Daily Eagle, July 13, 1936. Courtesy the Brooklyn Public Library, Brooklyn Collection.

77. Partridge Statue of Alexander Hamilton Relocated in Front of the Grange. Photograph by L.D. Thornton, 1955. Courtesy the American Scenic and Historic Preservation Society.
78. The Grange: Evidence of Original Piazza Roof. NPS photograph by Wilbur G. Elting, 1978-1979.
79. The Grange: Evidence of Original Portico Roof. NPS photograph by Barry Sulam, 1979.
80. The Grange: West Elevation, Shutters of Triple-Hung Windows. NPS photograph by Jack E. Boucher, 1962.
81. The Grange: West Elevation, Replacement Sidelights of Main Entrance. NPS photograph by Jack E. Boucher, 1962.
82. The Grange: X-Ray Showing Construction of Nonbearing Partition Walls. NPS photograph, 1977.
83. The Grange: Plaster Laid Beneath Floorboards. NPS photograph by Anne D. Whidden, 1977.
84. The Grange: "Reproduction" Light Fixtures, c. 1933. NPS photograph by Anne D. Whidden, 1977.
85. The Grange: Plan of Present First Floor. Drawing by Anne D. Whidden, 1977.
86. The Grange: Entry Hall, Floorboard Evidence of Original Main Stairwell. NPS photograph by Anne D. Whidden, 1977.
87. The Grange: Entry Hall, Framing Evidence of Original Main Stairwell. NPS photograph by Jack E. Boucher, 1964.
88. The Grange: Entry Hall, Plaster Scars from Original Main Stair Hall Partitions and Stair. NPS photograph by Jack E. Boucher, 1964.
89. The Grange: Second-Floor Southwest Room, Floorboard Evidence of Original Main Stairwell. NPS photograph by Anne D. Whidden, 1977.
90. The Grange: Second-Floor Southwest Room, Floorboard Evidence of Original Main Stairwell. NPS photograph by Anne D. Whidden, 1977.
91. The Grange: Second-Floor Southwest Room, Plaster Scar from Original Main Stair Handrail. NPS photograph by Jack E. Boucher, 1964.
92. The Grange: Conjectural Plan of Original Main Stair. Drawing by Sharon K. Ofenstein, 1978.
93. The Grange: East Octagon Room, Damage to Ceiling of Bay, c. 1960. NPS photograph by Jack E. Boucher, 1964.
94. The Grange: c.-1885 Replacement Mantel, East Octagon Room. NPS photograph, 1964.

95. The Grange: Plan of Present Second Floor. Drawing by Anne D. Whidden, 1977.
96. The Grange: Second-Floor Southwest Room, X-Ray through Frame and Casing of Hall Doorway. NPS photograph, 1977.
97. The Grange: Second-Floor Southwest Room, X-Ray through Casing of Doorway to West Center Room. NPS photograph, 1977.
98. The Grange: Second-Floor Southeast Room, Plaster Scars and Framing Evidence of Original Attic-Stair Compartment and Its Doorway. NPS photograph by Jack E. Boucher, 1964.
99. The Grange: Attic, Framing Evidence of Original Attic Stair. NPS photograph by Jack E. Boucher, 1964.
100. The Grange: Second-Floor Northwest Room, X-Ray through 1810-1820 Partition Wall. NPS photograph, 1977.
101. The Grange: Second-Floor Northwest Room and North Hall, Original and Continuous Cornice, South Wall. NPS photograph by Jack E. Boucher, 1964.
102. The Grange: Second-Floor Center Hall, X-Ray through Casing of Original Doorway to North Rooms. NPS photograph, 1977.
103. The Grange: Second-Floor North Hall, X-Ray through Casing of 1810-1820 Doorway to Northeast Room. NPS photograph, 1977.
104. The Grange: Attic, Roof and Floor Framing. Photograph by Jack E. Boucher, 1964.
105. The Grange: Attic, Roof Framing. NPS photograph by Jack E. Boucher, 1964.
106. The Grange: Framing Evidence of Settlement. NPS photograph by Jack E. Boucher, 1964.
107. The Grange: Exterior Paint Sample, Original Siding Paint. NPS photograph no. HAGR 01 S363 by Carole E. Perrault, 1978.
108. The Grange: Exterior Paint Sample, Original Primer for Siding Paint. NPS photograph no. HAGR 01 S349 by Carole E. Perrault, 1978.
109. The Grange: Exterior Paint Sample, Original Cornice Paint. NPS photograph no. HAGR 01 S026 by Carole E. Perrault, 1978.
110. The Grange: Exterior Paint Sample, Early Piazza Floor Paint. NPS photograph no. HAGR 01 S377 by Carole E. Perrault, 1978.
111. The Grange: Exterior Paint Sample, Original Piazza Roof Paint. NPS photograph no. HAGR 01 S335 by Carole E. Perrault, 1978.
112. The Grange: Exterior Paint Sample, Original False-Chimney Paint. NPS photograph no. HAGR 01 S361 by Carole E. Perrault, 1978.

113. The Grange: Interior Paint Sample, North-Apse Wall. NPS photograph no. HAGR 01 S422 by Sharon K. Ofenstein, 1981.
114. The Grange: Interior Paint Sample, Wall Under 1810-1820 Partition. NPS photograph no. HAGR 01 S423 by Sharon K. Ofenstein, 1981.
115. The Grange: Interior Paint Sample, First-Floor Southeast Room, Casing of Hall Doorway. NPS photograph no. HAGR 01 S093 by Sharon K. Ofenstein, 1981.
116. The Grange: Interior Paint Sample, Second-Floor Southeast Room, South Window Frame Below Sash Cord Pulley Plate. NPS photograph no. HAGR 01 S195 by Sharon K. Ofenstein, 1981.
117. The Grange: Interior Paint Sample, First-Floor Northwest Room, North Wall, Panel below West Window. NPS photograph no. HAGR 01 S131 by Sharon K. Ofenstein.
118. The Grange: Interior Paint Sample, Second-Floor Southeast Room, Knothole in Floor. NPS photograph no. HAGR 01 S181 by Sharon K. Ofenstein, 1981.
119. The Grange: Mechanism of Front Door Lock. NPS photograph by Anne D. Whidden, 1977.
120. The Grange: Brass Doorknobs of Front Door Lock. NPS photograph by Anne D. Whidden, 1977.
121. The Grange: Mechanism of Lock Presumably from Original Rear Door. NPS photograph by Anne D. Whidden, 1977.
122. The Grange: Mechanism of Early Mortise Lock, Door to First-Floor Southeast Room. NPS photograph by Anne D. Whidden, 1977.
123. The Grange: Mechanism of Early Rim Lock, Hall Door to Second-Floor Northeast Room. NPS photograph by Anne D. Whidden, 1977.
124. The Grange: Exterior Shutters, Pintle and Strap Hinge. NPS photograph by Anne D. Whidden, 1977.
125. The Grange: Exterior Shutters, Shutterdog. NPS photograph by Anne D. Whidden, 1977.
126. The Grange: Exterior Shutters, Flat Shutterbolt. NPS photograph by Anne D. Whidden, 1977.
127. The Grange: Exterior Shutters, Barrel Bolt. NPS photograph by Anne D. Whidden, 1977.
128. The Grange: Exterior Shutters, Tab and Pin Fastener. NPS photograph by Anne D. Whidden, 1977.
129. The Grange: Exterior Shutters, Strap and Button Fastener. NPS photograph by Anne D. Whidden, 1977.
130. The Grange: Drawing of Nail Types by Sharon K. Ofenstein, 1978.

HISTORICAL DATA SECTION

Alfred Mongin
Historian
Federal Hall National Memorial
New York City National Park Service Group

April 1965

I. INTRODUCTION

The house called "Grange" was designed by John McComb, Jr., at the height of his career as the architect to important members of the New York Federalist hierarchy. The Grange is the only surviving example of domestic architecture designed or built by McComb. For this reason alone, it is worthy of preservation and interpretive display. Of course, it was also the most significant residence of Alexander Hamilton. That the house was designed and built by McComb for Hamilton — and that the house is so much identified with the culminating years of Hamilton's life — are circumstances that make this house one of the architectural and historical treasures of our national heritage.

After the death of Alexander Hamilton in 1804, his widow and children continued to occupy the property until it passed into other hands in 1833. For half a century more, until the early 1880's, it was occupied successively as a summer home by several affluent New York families. The house's story during these middle decades of the 19th century, which is only touched upon in this report, is the story of Harlem as an early "suburbia" for wealthy Manhattanites. This episode also deserves a place in the full history of the Grange and its environment, when that is ultimately related.

The Grange, as a structure of wood and mortar and brick, heretofore has not occupied a major place in the numerous biographies of Alexander Hamilton. Most of those have been concerned with Hamilton as a political figure and economic planner involved in the founding of the nation. Despite this lack of formal notice, sufficient mention and records of the house have survived to relate its physical history in some detail. Undoubtedly a great deal more contemporaneous description remains to be discovered in future years, that will expand our knowledge about the house and those who lived therein. Principal major sources not yet searched are the various archival collections concerning the Ward family of Rhode Island and New York, and most of the material concerning those of Hamilton's friends who preserved the financial integrity of his estate following his untimely death in 1804. The single most important document still missing is the original construction drawings for the Grange by John McComb, Jr. These should be presumed extant, and may one day come to light.

II. ORIGINAL SITE SELECTION

In November 1798, Alexander Hamilton wrote from Philadelphia to his wife, Elizabeth Schuyler Hamilton:

...I have formed a sweet project, of which I will make you my confident, when I come to New York, and in which I rely that you will cooperate with me cheerfully.

You may guess and guess and guess again
Your guessing will be still in vain.

But you will not be the less pleased when you come to understand and realize the scheme.[1]

The "scheme" was to purchase land in upper Manhattan, there to create a country seat for Mr. and Mrs. Alexander Hamilton and family: to build a suitable residence and join the ranks of prominent and affluent New Yorkers already thus ensconced.

At that time, Alexander Hamilton had been on the American mainland for 26 years.[2] He had served the Colonial cause with great honor, had been a main force in the creation and adoption of the Constitution, and had served in the Cabinet of George Washington as the first Secretary of the Treasury. Now he was a leader at the Bar of New York. Also at that time, Hamilton had been married to Elizabeth Schuyler for 18 years,[3] and he and his wife looked forward to creating an establishment adequate for their growing family and appropriate to their station in life, but still within the means they could then afford.

A location in Harlem also would fill other requirements of a more practical nature. From 1793, when Hamilton had nearly succumbed to an attack of yellow fever,[4] his health had been fragile — although he continued to drive himself forward in his professional practice, apparently without restraint.[5] A Harlem location would permit him to spend most evenings of the week and all of his weekends in the healthful, fever-free country. The location was also convenient to Hamilton's professional travels up and down the Hudson Valley, and more centrally located than any other rural location within "commuting" distance of downtown New York for frequent trips between the Schuyler family at Albany, and the other Schuyler daughters and grandchildren.[6]

Hamilton had left the office of Secretary of the Treasury in 1795 poorer than he had come to it,[7] planning to set his personal financial house in order by dint of several years of application to the practice of law.[8] As he completed three years of this work, Hamilton and John Barker Church — the husband of Mrs. Hamilton's eldest sister[9] — rented a country house in Harlem for their families to occupy for the summer and autumn of 1798.[10] Hamilton's half of the rental was \$37.50.[11] The precise location is not known, but it was "...a country house in the neighborhood of what was afterward his own estate." [12] The country house rented by Hamilton and Church in 1798 may well have been the same house that the Hamilton family occupied 1800-1802 while its new house, which would become the Grange, was under construction.

It was after this stay in the Harlem country house that Hamilton wrote the note to his wife — quoted in part at the beginning of this chapter — with which the story of the Grange begins.[13] All that had taken place in Hamilton's life before that communication appears directed toward the values he would attempt to build into the life that he and his family would experience at the Grange, which was to be expressive of his success in his public and private life.

The period 1798-1800 constituted an important chapter in Hamilton's life, during which he again served his country, this time organizing the government's resources for a possible war with France. This period of limited hostilities has since been called the "quasi-war." This service drew him once again from his escalating law practice,[14] and deferred once again the achievement of financial solvency and security as the fruits of his professional labors.

Hamilton himself summarized the dilemma in which he found himself — torn between his desire for public service and his need for the income from his law practice — in a letter to Secretary of War James McHenry, dated January 7, 1799:

...I have discontinued my practice as attorney and solicitor, from which I had derived a considerable part of my professional profits;....

The very circumstance of my having accepted a military appointment, from the moment it was known, withdrew from me a large portion of my professional business. This, it will be perceived, was a natural effect of the uncertainty of my being able in the progress of suits to render the services for which I might be engaged, at the customary previous expense to the parties.

The result has been, that the emoluments of my profession have been diminished more than one half, and are still diminishing, and I remain in perfect uncertainty whether or when I am to derive from the scanty compensations of the office even a partial retribution for so serious a loss.

Were I rich, I should be proud to be silent on such a subject. I should acquiesce without an observation as long as any one might think the minutest public interest required an accumulation of sacrifices on my part. But after having to so advanced a period of my life devoted all my prospects of fortune to the service of the country, and dependent, as I am, for the maintenance of a wife and six children on my professional exertions, now so seriously abridged, it is essential for me to forego the scruples of delicacy, and to ask of you to define my situation, that I may determine whether to continue or to change my present plan.[15]

Hamilton spent lavishly from his store of energy in his management of the nation's military establishment during the two years of the "quasi-war." He not only was carrying on a sustaining part of his law practice, but at the same time was attempting to organize a functioning military establishment; establish a system of

instruction to provide continuity to the army's training operations (soon afterward realized in the establishment of the military academy at West Point); and to effect a number of other public reforms and improvements of benefit to his adopted city of New York.[16]

General Philip Schuyler, Hamilton's father-in-law — expressing his continuing concern for the welfare of Hamilton — wrote from Albany to Mrs. Hamilton on February 1, 1799:

My dearly beloved Eliza: I am deeply affected to learn that my beloved Hamilton is so much indisposed. Too great an application to business and too little bodily exercise have probably been the cause of his disorders, immersed as he is in business, and his mind constantly employed he will forget to take that exercise, and those precautions which are indispensable to his restoration. You must therefore, my Dear Child, order his horse every fair day, that he may ride out, and draw him as frequently from his closet as possible...try to prevail on him to quit the busy scene he is in, and to pay us a visit accompanied by you....[17]

Despite the many and increasing demands upon his time and energies, coupled with the problems occasioned by the decrease in his professional income, Hamilton continued his plans for a country house in Harlem. To his friend, Ebenezer Stevens, he wrote on October 25, 1799, that:

If the owner of the ground adjoining you will take Eight hundred pounds (£800) for sixteen acres including a parcel of the wood land and lying on the water the whole breadth, you will oblige me by concluding the bargain with him & I will pay the money as soon as a good title shall appear. If he will not sell a part at this rate, I request you to ascertain whether he will take Thirty pounds an acre for the whole tract and let me know. If I like it, after another view of the premis[es], I shall probably take the whole at this price. But I can only pay one half down, a quarter in six months and the remaining quarter in a twelve month. He shall be satisfied on the score of security if he desires.[18]

Stevens had a country home near the land that Hamilton wished to purchase[19] — as did a number of Hamilton's other friends and acquaintances — and he appears to have been seeking property appropriate to Hamilton's design, with full knowledge of Hamilton's desires in the matter. The property discussed by Hamilton in the letter comprised a tract of land on upper Manhattan Island bordered on the east by present-day St. Nicholas Avenue, on the north by present-day 145th Street, on the south by present-day 141st Street, and on the west by the Hudson River.[20] The area is bisected by the Bloomingdale, or Albany, Road into two parcels of approximately 15 or 16 acres each. Hamilton was interested in the parcel west of this road, along the river. In addition to being in the general area favored by Hamilton, this location would afford him direct access to two main arteries of Hudson Valley travel: the Bloomingdale Road and the river. If the owner would sell only a part of the land, Hamilton preferred to deal for the land between the Bloomingdale Road and the Hudson "...lying on the water the whole breadth...."

While negotiations progressed, two events came to pass in which Hamilton played a principal role. The results of these elevated his personal situation back to the level where it was before the "quasi-war." The first event was the hearing of the appeal in the case at law titled LeGuen vs. Gouverneur and Kemble. The second was the conclusion of the "quasi-war."

The LeGuen case was the most important commercial case of Hamilton's legal career.[21] Both sides had sought to have him represent their respective causes, and Hamilton was thereby in a position either to consolidate his position as the leader of the New York Bar, or to fall disastrously from favor, depending upon his performance in this celebrated case. His co-counsel for LeGuen was Aaron Burr. They were opposed by equally able and distinguished counsel, chief among whom was Gouverneur Morris, recently returned from extended European travels.[22] The claim by Hamilton's client, LeGuen, was for a very large amount -- the largest amount of any case tried by Hamilton in his professional practice -- and after trials at law and the most persevering and irritating litigation, the matter was argued before the New York Court of Errors during the winter of 1800.[23] The decision was in LeGuen's favor -- due in a very material degree, it was thought, to the overbearing weight and influence of Hamilton's talents.[24] The fee which Hamilton received for his services, though modest even by standards of the day,[25] apparently gave him sufficient confidence to proceed with his plans for a country house.

The end of the "quasi-war," and the dispersal of the provisional army in June 1800, gave Hamilton once again the freedom to devote his apparently boundless energies and enthusiasm to his law practice and to the needs of his increasing family.[26]

In Hamilton's letter to Stevens of October 25, 1799, he had suggested two options. He preferred to purchase only the parcel west of the Bloomingdale Road, along the Hudson River; as an alternative, he would offer to purchase both parcels, extending eastward from the Hudson to approximately the present line of St. Nicholas Avenue. Apparently neither of these proposals suited the owner, Jacob Schieffelin, who desired the river site for his own use. He was willing to dispose of only the parcel east of the Bloomingdale Road, however.[27] So it was this third alternative, which had less appeal for Hamilton, that appeared as the final point of agreement. Hamilton purchased the parcel from Schieffelin on August 2, 1800, for \$4,000.[28] Illustration 1 shows how the original Schieffelin property was divided by the sale. Schieffelin accepted a mortgage from Hamilton for the full amount, at seven percent interest per annum, payable annually.[29] The annual interest payment of \$280 was made by Hamilton each year while he lived, and the mortgage was satisfied by the executors of his estate.[30] The parcel measured 15 acres, one rood, and ten perches in extent.[31] In Illustration 1, this parcel is labeled, "Hamilton," while the adjoining parcel between it and the river is labeled "Schieffelin." Thus, the land purchased by Hamilton on August 2, 1800, formed the nucleus of the Grange estate. It was on this parcel that the Hamilton country house -- called the Grange -- was built.

The parcel of land purchased by Hamilton is platted in Illustration 2. The following is quoted from the Instrument of Conveyance:

...This indenture made the Second day of August in the year of our Lord one thousand eight hundred Between Jacob Schieffelin of the City of New York Druggist and Hannah his wife of the one part and Alexander Hamilton of the Same place counsellor at Law of the other part Witnesseth that the said Jacob Schieffelin and Hannah his wife for and in consideration of the Sum of Four Thousand dollars...paid by the said Alexander Hamilton at or before the sealing and delivery of these presents their accept[ance] of which is hereby acknowledged. Have granted bargained sold aliened released and confirmed and by these presents do grant bargain sell alien release and confirm unto the said Alexander Hamilton his heirs and assigns All that part which lies Eastward of the Bloomingdale road of a certain lot or parcel of land in an Indenture bearing date the Fifteenth day of January in the year one thousand seven hundred and ninety nine made between Samuel Kelley and Johanna his wife of the one part and the aforesaid Jacob Schieffelin of the other part thus described Viz all that certain lot of land lying and being at Haerlem in the Seventh Ward of the City of New York aforesaid Containing thirty four acres (or more if the same shall on survey be found to exceed that quantity being the South westernmost half part of lot number Six or thirty three Morgan lot and is bounded as follows viz: Northerly by the Northernmost half part of said lot numbers Six late in the possession of Lieutenant Colonel John Mannsell now in the possession of Doctor Bradhurst Westerly by the North River, Southerly by the land late of Aaron Bussing now of Mott and Easterly by the land of John Myer and which part of said lot according to a survey...by Benjamin Taylor City Surveyor as exemplified in the Map hereunto annexed by outlines coloured with green is Bounded Eastwardly by a line North thirty nine degrees East Nine chain and eighty five links westwardly by a line fifty eight degrees and thirty minutes West ten chains and forty five...being the Eastwardly side of the said bloomingdale road Northwardly by a line North thirty nine degrees west thirteen chains and seventy links. Southwardly by a line South forty one degrees East Seventeen Chains and seventeen links and Contains fifteen acres one rood and ten perches by the same more or less. Together with all and singular...the use privilege benefit and advantage in common with the Said Jacob Schieffelin his heirs and assigns of the road now laid out and running through the remainder of the aforesaid lot of land in the possession of the said Jacob Schieffelin being the Southern extremity thereof twelve feet from Bloomingdale Road aforesaid to the North [River?] aforesaid so nevertheless that the said Alexander Hamilton his heirs or assigns shall never cut down or injure any trees or remove any fences which shall not obstruct or hinder the free use of the road hereby granted as and for a road...And the said Jacob Schieffelin doth hereby for himself heirs executors and administrators, covenant and agree and with the said Alexander Hamilton his heirs and assigns in manner and form following that is to say Fi[rst?] That the

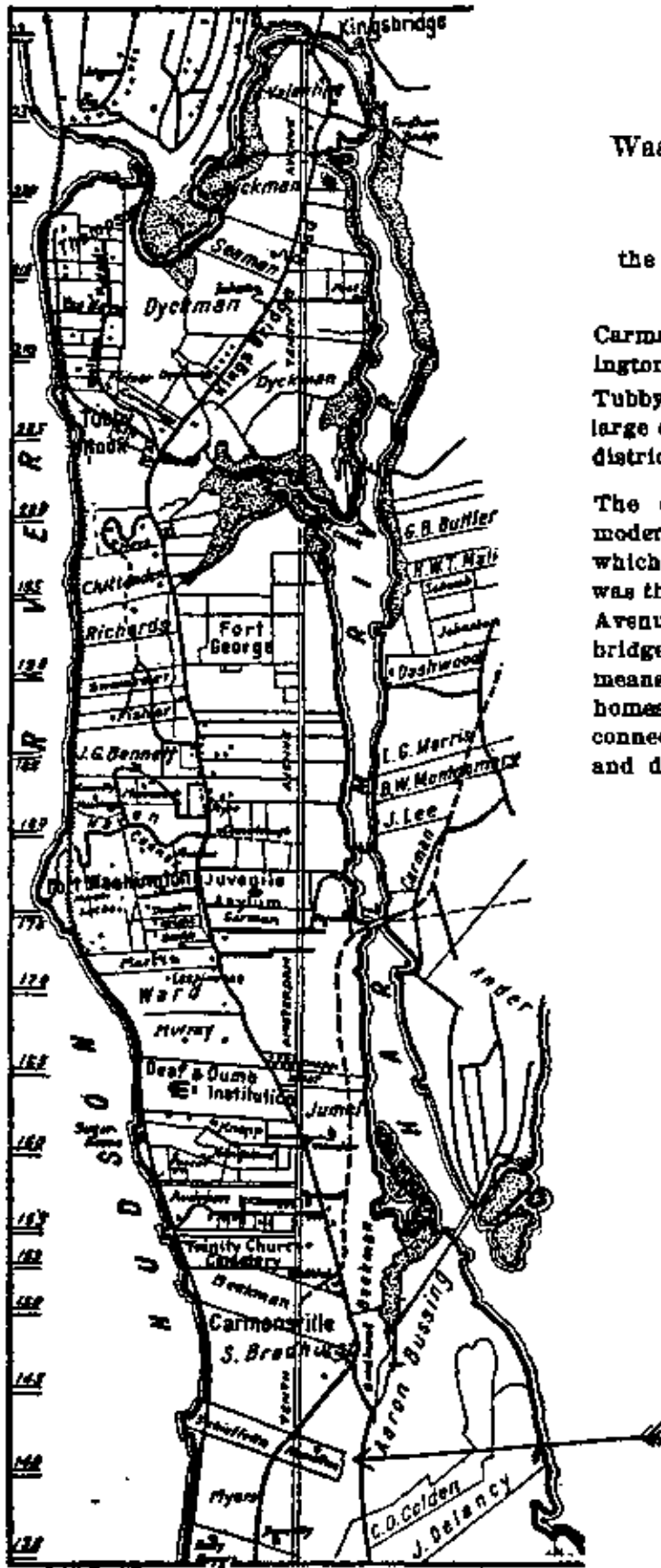

IV

Washington Heights,
1850-60,

the district then being
known as

Carmansville, Fort Wash-
ington, Fort George, and
Tubby Hook, showing the
large estates into which the
district was divided.

The only avenue in our
modern street system
which was partly laid out
was the 10th or Amsterdam
Avenue. The old Kings-
bridge road was still the
means of access to the
homes of the residents,
connected by private lanes
and driveways.

Illustration 1. The Grange Property (August 2, 1800).

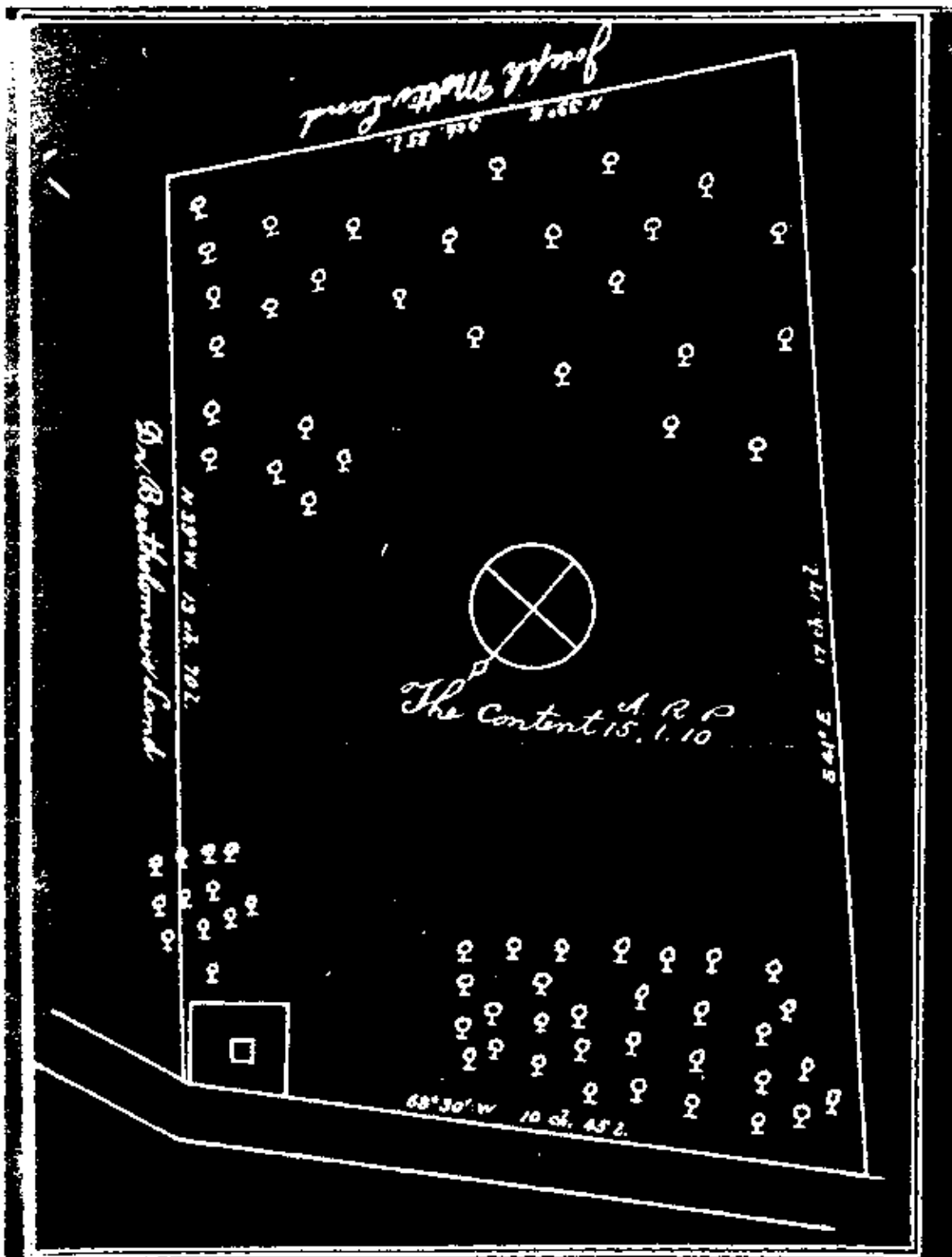

Map accompanying Deed of Jacob Schieffelin and Hannah his wife
 to Gen Alexander Hamilton dated Aug 2, 1800.
 Retraced from a pencil tracing of original made by Henry Whittmore.
 Distances and azimuths are added from deed. Scale appears to be
 $\frac{1}{2}$ inch = 1 chain
 American Scenic and Historic Preservation Society

Illustration 2. Plat of the First Section of Grange Property (c. August 1800).

said part of the said lot of land hereby granted and conveyed doth not contain less than Fifteen Acres Secondly that he the said Jacob Schieffelin at and immediately before the sealing and delivery of these presents...seised of a good sure perfect and indefeasible estate inheritance in fee simple of in and to the said part of said lot of land and premises above granted and...Thirdly that he hath in himself good right and full power and authority to grant bargain release and convey the same in manner and form as the same is hereby released and conveyed. Fourthly that he the said Alexander Hamilton his heirs and assigns shall at all times hereafter peaceably and quietly have hold use occupy possess and enjoy the same without the let suit trouble hindrance or molestation of any person or persons whomsoever...that the same now is and forever henceforth shall remain free and clear and freely and clearly exonerated and discharged of from and against any and every gift and mortgage Judgment recognizance or other....[32]

This conveyance remained unrecorded until April 3, 1824.[33] In 1929, a descendant of a later owner of the Grange announced that she had the original Instrument of Conveyance in her possession, and that it would be donated to the Grange when the building was restored.[34]

The property purchased had been a desirable parcel of land even in the 17th century. Illustration 3 gives a topographical view of the area. The first subdivision that included Hamilton's parcel of land transpired in 1691,[35] one of a series of divisions and subdivisions of the upper west side of the island of Manhattan between 1658 and 1712. Illustration 4 shows the end result of these settlements; the property later to be the site of the Grange (marked by an arrow) appears in section IX of "Jochem Pieter's Hills."

The metes and bounds of lot IX in the 1691 division would approximate 140th Street on the south, the Hudson River on the west, 145th Street on the north, and St. Nicholas Avenue on the east.[36] In 1691, lot IX passed to the estate of Captain John Delavall, the son of Thomas Delavall, an early mayor of New York.[37] Delavall's heirs divided the parcel into two east-west strips, so that each parcel enjoyed access to the Hudson; they sold the southern section, on which the Grange would be built, to one Samuel Kelly or Kelley.[38] Kelly sold his purchase in 1799 to Jacob Schieffelin, druggist, of New York City,[39] who conveyed the land-locked half lying east of the Bloomingdale Road -- now Hamilton Place -- to Alexander Hamilton.[40] The parcels sold by the heirs of Captain John Delavall to Samuel Kelly, by Kelly to Schieffelin, and by Schieffelin to Hamilton can be identified in Illustration 1.

Alexander Hamilton wanted to make his home in this area for several reasons. He had served here in the dark, early days of the Revolution. According to one account, which at least one eminent biographer of Hamilton believes, it was during the action at Harlem Heights in 1776 that Hamilton first came to the notice of George Washington, resulting in Hamilton's addition to the General's personal staff.[41] Reason enough, indeed, for a man to savor past glory amidst present success.

Thirteen years later, in 1789, Hamilton was back in the area under happier circumstances. New York City was the seat of the newly formed government under the Constitution, and Washington the first President of the Republic. Alexander and Elizabeth Hamilton on a number of occasions rode with the President and Martha Washington on the Washingtons' favorite New York carriage drive, "the 14 miles 'round," the route being over the old Bloomingdale Road up to the high bluff later called "Claremont," thence across the Kingsbridge and Old Boston Roads for the return to lower Manhattan.[42] During the controversy in Congress over selection of the site for the permanent seat of the government, these heights on the Hudson were among the locations discussed. While the question still was pending, a pleasure party was inaugurated to drive to Bloomingdale and Harlem Heights — ostensibly to visit the battlefields, but chiefly to discuss the fine views from the picturesque elevations.[43]

Hamilton's own first choice for his country seat appears to have been the Claremont site, but that was not available.[44] His second choice was either all, or the riverward half, of the Schieffelin tract. Although he had to settle for his third choice — the landward half of the tract — this parcel was still a part of the Harlem area remembered fondly by Hamilton in 1799. It also included a small plateau (see Illustration 3) that would make a good house site. Thus, this parcel formed the nucleus of the budding Grange estate.

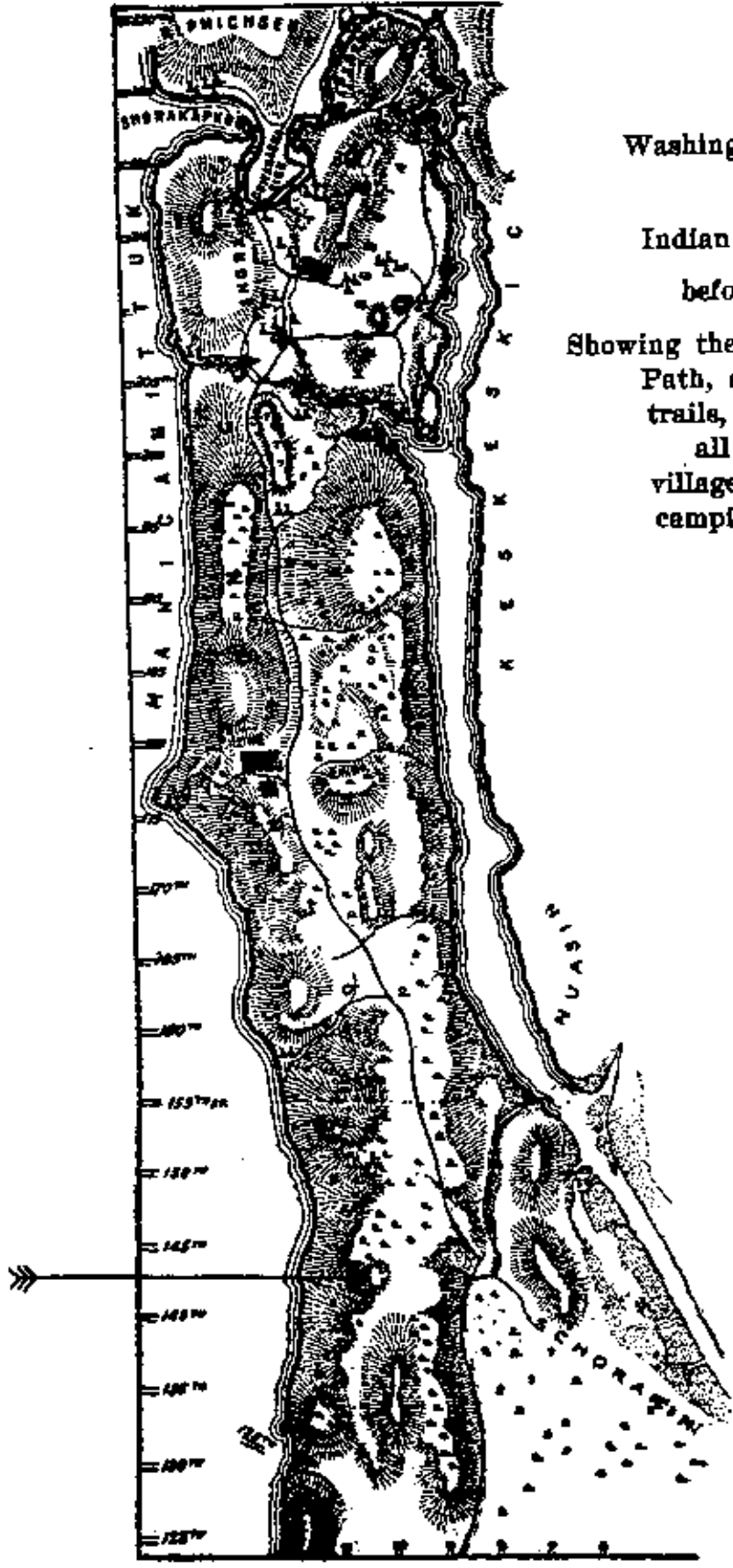

I
 Washington Heights
 in
 Indian possession
 before 1600.

Showing the Weckquaesgeek
 Path, and branch
 trails, connecting
 all known
 village sites and
 camping places.

Illustration 3. Topographical Map of the Grange Vicinity (before 1600).

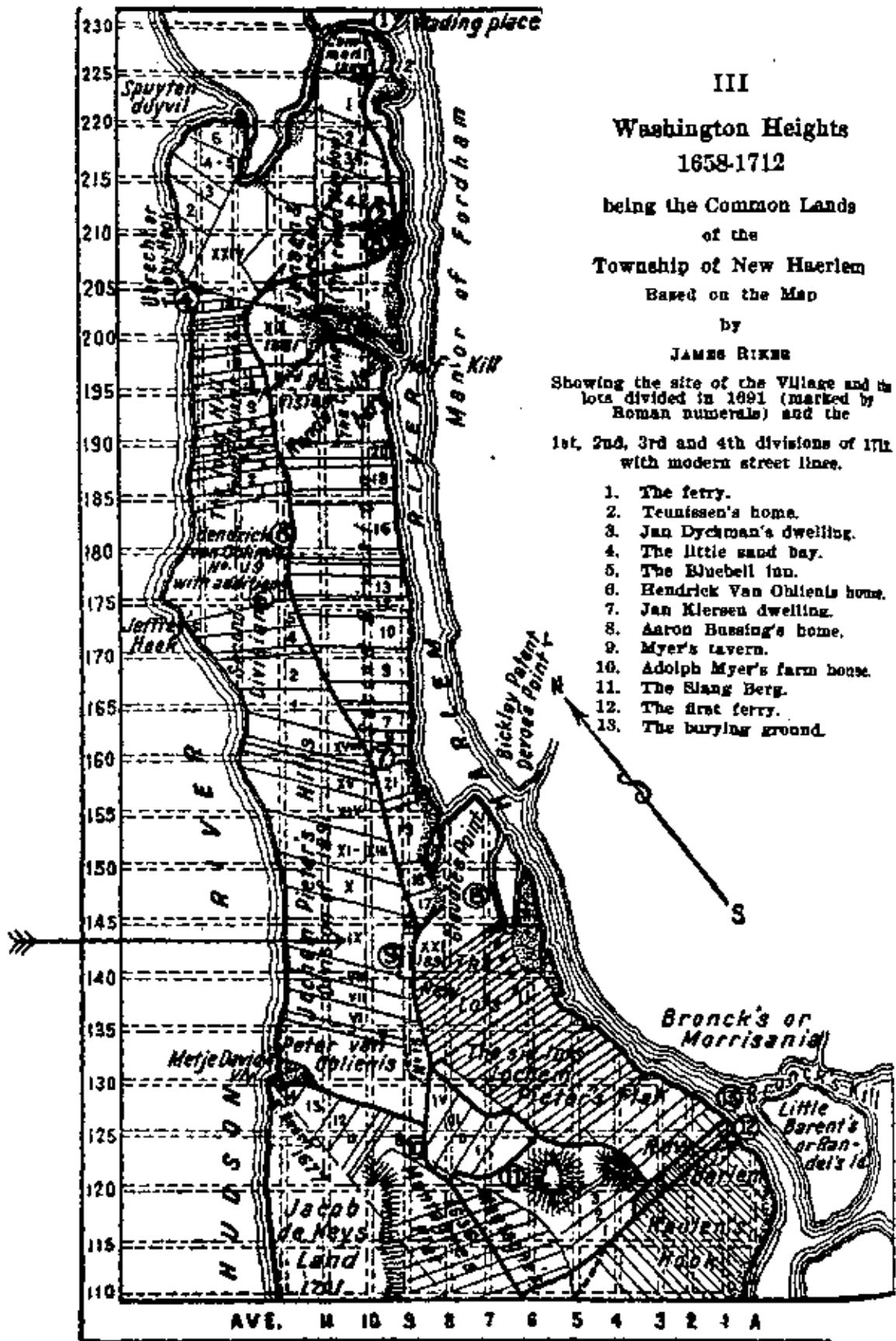

III
Washington Heights
1658-1712
 being the Common Lands
 of the
Township of New Haerlem
 Based on the Map

by
JAMES RIKKE

Showing the site of the Village and the
 lots divided in 1691 (marked by
 Roman numerals) and the
 1st, 2nd, 3rd and 4th divisions of 1711
 with modern street lines.

1. The ferry.
2. Teunissen's home.
3. Jan Dychman's dwelling.
4. The little sand bay.
5. The Bluebell inn.
6. Hendrick Van Oolthoff's home.
7. Jan Kiersen dwelling.
8. Aaron Bussing's home.
9. Myer's tavern.
10. Adolph Myer's farm house.
11. The Slang Berg.
12. The first ferry.
13. The burying ground.

Illustration 4. Subdivision Plan of the Grange Vicinity (1658-1712).

NOTES

1. Allan M. Hamilton, The Intimate Life of Alexander Hamilton, pp. 43-44; Richard B. Morris, ed., Alexander Hamilton and the Founding of the Nation, p. 577.
2. Broadus Mitchell, Alexander Hamilton: Youth to Maturity, 1755-1788, p. 36.
3. Elizabeth Schuyler was married to Alexander Hamilton in the Schuyler mansion, Albany, New York, Dec. 14, 1780. See Mary Gay Humphreys, Catherine Schuyler, p. 185.
4. Hamilton, Intimate Life, pp. 222-224; Broadus Mitchell, Alexander Hamilton: The National Adventure, 1788-1804, pp. 281-285; J.H. Powell, Bring Out Your Dead, v-vi, pp. 107-108.
5. Hamilton, Intimate Life, pp. 17-19; James A. Hamilton, Reminiscences, pp. 1-2.
6. Humphreys, Catherine Schuyler, pp. 228-230.
7. Humphreys, Catherine Schuyler, pp. 232-233; Hamilton, Reminiscences, p. 6.
8. Humphreys, Catherine Schuyler, p. 233; Hamilton, Reminiscences, p. 3; Hamilton, Intimate Life, pp. 264-265.
9. Hamilton, Reminiscences, p. 60.
10. Hamilton, Intimate Life, p. 337.
11. Ibid., p. 236.
12. Hamilton, Intimate Life, p. 337.
13. Ibid.
14. Ibid., pp. 320-321. See also James Kent to EH, Dec. 20, 1832, AHP/LC.
15. AHP/LC. Compare Morris, Hamilton, pp. 597-598.
16. Hamilton, Intimate Life, pp. 256, 320-321, 333. See also I.N. Phelps Stokes, The Iconography of Manhattan Island, V, pp. 1356, 1362-1363, and VI, p. 429; AH to John Jay, Feb. 12, 1799, Fuller Mss. Collection (III, D, IA, Princeton University Library); Kent to EH, Dec. 20, 1832.
17. Hamilton, Intimate Life, p. 257.
18. LC; Hamilton, Intimate Life, pp. 337-338.

19. Hamilton, Intimate Life, p. 337.
20. Ibid.
21. Ibid., p. 169.
22. Howard Swiggett, The Extraordinary Mr. Morris, p. 340; Theodore Roosevelt, Gouverneur Morris, p. 320.
23. Hamilton, Intimate Life, pp. 169-171; AH to EH, Feb. 5, 1800, PAHPP.
24. Kent to EH, Dec. 20, 1832.
25. Charles R. King, ed., Life and Correspondence of Rufus King, III, p. 159. See also Hamilton, Intimate Life, pp. 169-171.
26. "AN ACT Supplementary to the act to suspend part of an act, entitled 'An Act to augment the army of the United States, and for other purposes,'" AHP/LC; Hamilton, Intimate Life, p. 333; Morris, Hamilton, p. 598.
27. M.T. Schieffelin to the editor, New York Times, Nov. 18, 1924, publ. Nov. 20, 1924. Allan M. Hamilton erred in assuming that Alexander Hamilton was able to acquire his second choice of land, and that the original Grange tract was bounded on the west by the Hudson River (see Hamilton, Intimate Life, p. 337).
28. NYCRC, "Conveyances," Liber 218, p. 223. See also AS&HPS, "Hamilton's Purchase of the Farm," Thirtieth Annual Report (1925), pp. 20-22; Stokes, Iconography, V, p. 1379; Martha J. Lamb, "Historic Homes and Landmarks: Their Significance and Present Condition," Magazine of American History, XXI, No. 1 (Jan. 1889), p. 6.
29. NYCRC, "Conveyances," Liber 218, pp. 375-380.
30. Ibid., p. 380.
31. See Note 28.
32. NYCRC, "Conveyances," Liber 218, pp. 223-226.
33. Ibid., p. 223.
34. Mrs. E.A.S. Clarke, granddaughter of Greene Ward, to Francis H. Sisson, Jr., Apr. 22, 1929, in AS&HPS files.
35. See Reginald P. Bolton, Washington Heights Manhattan: Its Eventful Past, pp. 83-85.
36. Bolton, Washington Heights, p. 91.
37. Ibid.

38. Ibid.
39. Ibid., pp. 91-92.
40. Ibid.
41. Mitchell, Youth to Maturity, pp. 89-90.
42. Martha J. Lamb, "General Grant's Resting Place, Its Historic Associations," Magazine of American History, XIV, No. 3 (Sept. 1885), pp. 233-234.
43. Ibid., p. 234.
44. Ibid.; see also Bushrod Washington to AH, Apr. 15, 1802, AHP/LC. Swigget errs in stating that the Grange was built here (p. 376).

III. DESIGN

An abode of some type already stood on the original Grange parcel when Alexander Hamilton received conveyance of this first section of the estate on August 2, 1800. The house stood on the north corner of the property, at the Bloomingdale Road (Ill. 2). It is possible that this building was the house that had been rented by the Hamilton and Church families in the summer and autumn of 1798.[1] At any rate, this house was occupied by the Hamilton family as its country home for two years while the new house — the Grange — was being built.

Immediately after the formal purchase of the property on August 2, 1800, repairs and alterations to make the farmhouse more livable were begun under the supervision of John McComb, Jr.[2] A photocopy of McComb's bill to Hamilton for labor and materials for this job is Illustration 5. The bill totals 28 pounds, 7 shillings, 2 pence.[3] Even though Hamilton sought to have decimal units utilized, both he and his contemporaries utilized European money system units and decimal system units interchangeably. Analysis of the Hamilton correspondence for this period indicates that the pound was equivalent to \$2.50, the shilling to \$.12-1/2, and the pence to slightly more than \$.01. Thus, the cost of refurbishing the farmhouse was approximately \$70.90. By the expenditure of this modest sum, the family had a summer home fully two years before the mansion house was completed. The Hamiltons would be well-established summer residents of the Harlem Heights community by the time their new house was ready in 1802.

As of August 1800, the Hamiltons had seven children. The eldest, Philip — named in honor of his maternal grandfather, General Philip Schuyler — had been born January 22, 1782. The other children were:

Angelica	born September 25, 1784
Alexander	born May 16, 1786
James Alexander	born April 14, 1788
John Church	born August 22, 1792
William Stephen	born August 4, 1797
Eliza	born November 20, 1799[4]

Alexander and James Alexander appear to have been attending a boarding school in New Utrecht.[5] Since 1795, the medical needs of this brood had been tended by Dr. David Hosack,[6] to whom Hamilton related through their mutual interest in gardening.

Now a resident of the area, Hamilton joined with 30 other Harlemites on August 26, 1800, in a petition to the mayor and Corporation of the City of New York. Their goal was to have the public post road between the Harlem Plain and present-day 147th Street relocated to another part of the valley. This was desired because the section of road between mileposts nine and 10 descended a dangerous hill, locally called "Breakneck Hill" since June 18, 1795, when the horses of the "Northern Stage" sped out of control down the hill, killing the driver and one passenger.[8] Action on the petition came more than three years later.[9]

The drawing of plans for the forthcoming mansion house commenced well before the formal purchase of the property on August 2, 1800. Consideration of the matter, and the execution of designs and plans, had occupied the Hamiltons and the Schuylers since late 1798. Now that the time was ripe for execution of the project, General Schuyler exhibited impatience. In a letter dated July 17, 1800 — 16 days before

Alexander Hamilton Esquire.

1800.

To John Albion Esq

Sep^r Repairing Farm House &c

~~2. Price of 200 Boards & 200 Shingles~~

6 " 1000 of Plaster 15 Casks Lime Hart 2 4

" 9 1/2 days Mason work 10 1/2 5 17

" 10 1/2 " Labour 8 5 10

10. In Exp^t for Freight as p^r bill 1 12

~~27. William Bentons as p^r bill~~

Oct 25 5 lb lath nails 6 18

2 bushels Hair 2 5

500 Plastering lath Shingles 11 9

3 1/2 days Mason work 13 2 5 0

2 1/4 " Labour 8 18

£ 28 7 2

Illustration 5. Bill for Renovation of Farmhouse on Grange Property.

Hamilton formally concluded the purchase of the property — General Schuyler wrote to Hamilton in some detail about the subject:

You have forgot to send me the plan of your intended house, and the bill of scantling.—And an Account of what boards and plank will be required, for I [plan] to have the boards & planks put into w[ater] for two months, then taken and stacked and properly covered, that they may be well seasoned before they are worked up. The [?] same boards purchased at NYork, are generally green, and the work makes [?] them liable to shrink.—... [10]

Hamilton sent the General a plan for his "intended house" on August 13, which was acknowledged on the 25th of August, with the additional comment by the General that

...If the house is boarded on the outside, and then Clapboards put on, and fitted on the inside with brick I am persuaded no water will pass to the brick, if the Clapboards are well painted, and fitting in with brick will be little if any more expensive than lath and plaister. The former will prevent the nuisance occasioned by rats and mice, to which you will be eternally exposed if lath and plaister is made use of instead of brick.

The partitions between the apartments in the interior of the house if made of [joists] and then lathed and plaistered also have vacancies as receptacles for rats & mice. It is a little but not much more expensive to have the partitions of planks of 2 or 2-1/2 inches thick set vertically from floor to ceiling and jointed together but not planed, on these planks the lath & plaister to be put and thus a solid partition is formed.

In the bill of Scantling which you have sent me I do not find any timber for the gutters, perhaps this has been omitted.

...I shall as soon as Cornelia[11] is brought to bed, go up and contract for the timber and purchase the boards & planks, and if possible I will cause the boards and planks to be put into water for two months and then piled up with sticks between them, that they may be seasoned before they are worked up.

It will save very considerable expense if the clapboards and boards for the floors were sawed to the proper breadth & thickness at the Saw mills. I therefore wish you to send me how many of each...will be wanted, their breadth & thickness.... [12]

By August 2, 1800, when the land purchase was formalized, planning for the new house was well advanced. Four main persons influenced the creation of the house and home to which Hamilton would apply the name "Grange," each in his or her own special way. These were Alexander Hamilton, Elizabeth Schuyler Hamilton, General Philip Schuyler, and John McComb, Jr.

Alexander Hamilton was the "entrepreneur" of the Grange idea. He provided the idea, the objectives, and the determination and organizing drive which saw his "sweet project" to its successful realization. Most of Hamilton's projects were designed to be realized in the future, through generations of men yet unborn. The Grange was one of his few ideas of human, mortal proportion, and one of the few that he himself saw completed in his lifetime. [13]

Elizabeth Schuyler Hamilton, wife of Alexander Hamilton and daughter of General Philip Schuyler, forged a bond between her father and her husband that gave strength to their public and private lives. [14] She was the chatelaine of the Grange very much in the pattern set for her by her mother, Catherine Van Rensselaer Schuyler (the General's "...sweet Kitty V.R...."). [15] Elizabeth Hamilton's social and political heritage was that bestowed by Catherine Schuyler upon all of her daughters, which is not to be discounted in its effects upon their individual households. [16]

Catherine Schuyler was of the fourth generation of the New York Van Rensselaers, [17] the most successful of the land-acquiring provincials of the Hudson Valley. [18] She was born at the family house called Fort Crailo, [19] on the east bank of the Hudson River opposite Albany, and was raised in another of the Van Rensselaer homes near the town of Hudson. [20] There is no doubt but that she conveyed a sense of the mansion-centered life to her children. Forty-odd years before construction of the Grange, when General Schuyler was in England on business, Catherine Schuyler had supervised the construction of the Schuyler mansion at Albany, New York. [21] In a similar show of ability, Elizabeth Hamilton would raise her family on the Grange property and supervise the day-to-day progress of construction on the new house and development of the grounds. (Her husband, though not abroad, would be conducting business at his Wall Street office, on trips, and "on circuit" throughout the Hudson River Valley. [22])

Elizabeth Schuyler was born, and spent much of her childhood, at the Albany mansion (Ill. 6), the family home of the Schuylers and a principal stopping place for visitors of prominence traveling up and down the valley. The second-floor hall of the house was designed to double as a ballroom for this sociable family. During those years there were few of eminence — whether citizen or foreign traveler — who did not accept at least the overnight hospitality of the general and his family. From George Washington to the lesser lights of the new nation, all who passed that way had admired the comely and charming Schuyler daughters. [23] The Schuyler mansion is the type of house Elizabeth Hamilton was accustomed to, and of which she would think when the Grange was being planned.

Earlier in this chapter are excerpts from a few of the numerous letters General Schuyler wrote to Hamilton, offering suggestions for details of construction of the Grange house and outbuildings, and of the layout of the Grange grounds. These suggestions were of a practical nature; most of them were adopted, and can be identified in the completed structure and in the fabric of the house as it stands today. [24]

The fourth major influence upon the design of the Grange was the man who drew the plans for the structure and who served as the major contractor for its construction. This man was John McComb, Jr., of New York City. Naturally, McComb's design reflected his client's wishes. Mrs. Hamilton and General Schuyler,

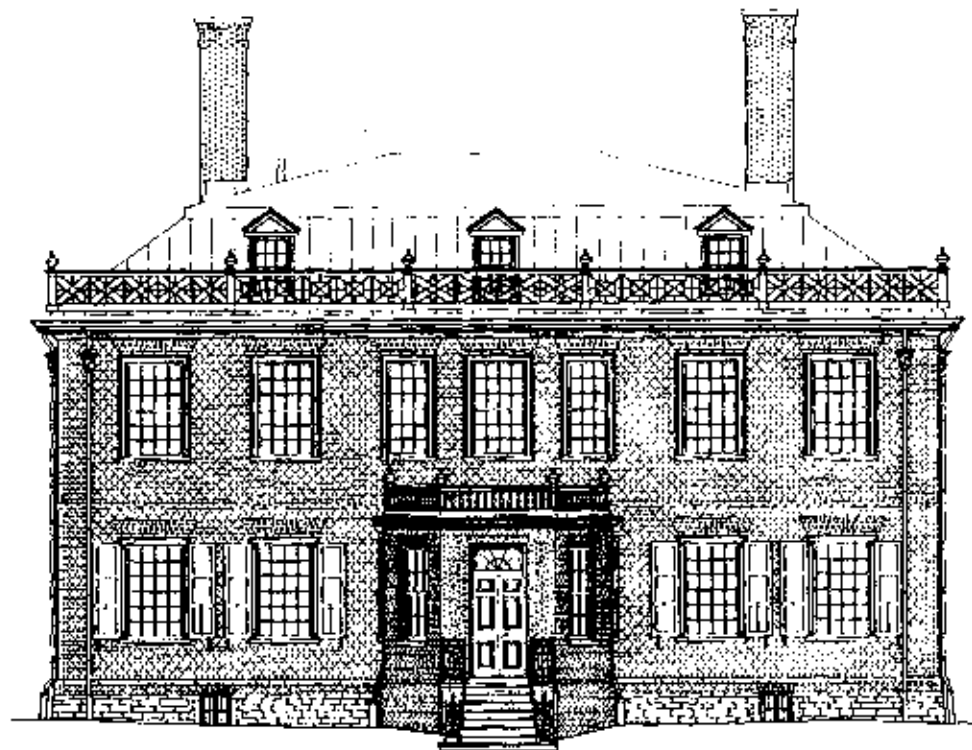

EAST ELEVATION

SCHUYLER MANSION, BORN IN 1761 AND BUILT TO THE DESIGN OF ITS OWNER GENERAL PHILIP SCHUYLER (1733-1804), IS THE HOME OF ALBANY FAMILY OF GEORGIAN ARCHITECTURE IN THE ALBANY AREA. THE MANSIONAL STRUCTURE, ADDED ABOUT 1815 BY A SUCCESSOR OWNER JOHN BROWN, IS PROBABLY ATTRIBUTED TO ALBANY ARCHITECT PHILIP HOOVER (1766-1866). CONSTRUCTION BEGAN IN NEW YORK STATE IN 1761 (EMPTER 28, LAWS OF 1761), AND THE HOUSE WAS OFFICIALLY OPENED TO THE PUBLIC IN OCTOBER 1947.

NOTES

GRADE: FIRST APPROXIMATE, REMOVED; COMED FROM DECEMBER, 1975.

BLOCK CORNICE AND BURL-IN GUTTER, IN OR PARTIALLY REMOVED FROM ELECTRICITY OF LEAD-COLORED COPPER GUTTER LINE, PRIMARILY 1815 OR LATER.

NEW LEAKS AND FLEATHERHEADS, ON WHICH D. STALL, 1966 BREAKDOWN, 1967 AND 1968 WITH OTHER APPROXIMATE

* FLUTE BLOCK: 1815, 1771-72

* BURL CORNER OF 375 YEARS, 7 COURSES IN WIDTH

* MOVED BURL WATERFALL

* PAINTED YELLOW PRIMARILY 1815, SANDBLASTED 1966

* CARVED ON BLOCK 10 FEET ABOVE WATERFALL NEAR

11K 376

* BROWN CORNER, ATTRIBUTED TO BREAKDOWN, 1815, 1815-1816

* LEAKS CAUSED BY MOVEMENT OF FLEATHERHEAD CORNER IN 1815 (1815-1816) AND 1815 WOULD HAVE BEEN ABANDONED BY INSTALLATION OF THE ROOF IN THE BASEMENT, JANUARY 1921.

* REPORTING TOOL, PLACE 1915-1916.

WINDOWS

* FRAME CORNER FOR CORNER AND ONE, PARTIALLY REPLACED 1815.

* SASH, 1815, 1815 REPLACED 1815. CENTURY AND LIGHT DESIGN (DOORWAY SASH, POSSIBLY 1815, 1815 CENTURY)

* SASHES AND BEETTER, 1815-1816.

* WINDOW MARKING, LEFT TO RIGHT:

BASEMENT: 1-1-6

FIRST FLOOR: 1-1-6

SECOND FLOOR: 1-1-6

ATTIC: 1-1-6

VEHICLE, 1815

1815, 1815, AND 1815 RESTORATION 1915-1916

AT THE SAME TIME, BEING REMOVED FROM THE HOUSE NECESSITATED INSTALLATION OF THE NEW STEEL

THE NEW AND RESTORATION OF 1815.

* BLOCK CORNER AND BURL-IN GUTTER, PARTIALLY REPLACED 1815.

* NEW LEAKS, 1815-1816, WITH TRACES OF 1815

* YELLOW PAINT BEHIND 1815

* WINDOWS, PROBABLY ORIGINAL TO 1815

* TRADITIONAL, 1815

* BLOCK CORNER, COMMON BURL WITH BURLS BEHIND 1815

* 1815; PROBABLY PAINTED WITH BROWN 1815-1816

* 1815-1816, 1815 AND 1815-1816, 1815, 1815.

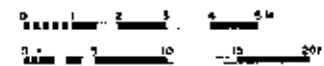

NEW YORK STATE OFFICE OF PARKS & RECREATION
DIVISION FOR HISTORIC PRESERVATION
SCHUYLER MANSION
ALBANY, ALBANY CO.
EXISTING CONDITIONS
EAST ELEVATION
DATE: JUNE 75
SCALE: 1/4" = 1'-0"

Illustration 6. Influences on the Grange Design: The Schuyler Mansion, Albany, N.Y. (1761 and 1815).

too, influenced the choice of functions provided for, as well as some of the elements eventually incorporated into the house's final design. But the form in which these were realized was the product of John McComb, Jr.

The most able commentator on McComb's work, Professor S. Damie Stillman, has written of the relationship of McComb to his clients:

The question now arises as to the influence of his clients upon McComb....

Because of a basic conservatism in McComb's architecture and among his clients, the possibility arises that his work may have been a conscious expression of taste. It is possible that McComb adapted his style to the demands of an expressed or hidden preference on the part of his clients....

There is...a distinct possibility that McComb's crystallized style, if not determined by a Federalist esthetic, either overt or unexpressed, was at least amenable to it. His clients may not have formed his basic style, but they possibly helped him to maintain it. If McComb's basic approach to architecture was that of the builder-architect and businessman, he saw quickly the trends of esthetic opinion and followed them. Within this framework, imposed perhaps as much by the esthetic preferences of his clients as by his own tradition and inclination, McComb labored as a sensitive designer. He never, except in unexecuted designs and sketches, extended himself beyond the frontiers of his developed style. Part of this reticence and conservatism was undoubtedly of his own making, but a large segment of it may have been conforming to the tastes or demands of his customers....

....[McComb's clients] would seem to have been economically well-off, conservative, and Federalist, and McComb would appear to have been at least amenable to their beliefs if not in complete agreement with them, which he probably was.... [25]

John McComb, Jr. (1763-1853) was eight years younger than Hamilton.[26] His father began his working life as a mason, but later became a builder and architect.[27] Much of young McComb's training came from his father, whose assistant he became in 1783.[28] Apparently he served the classic seven-year period of apprenticeship (whether formalized or not) to his father, since it was not until 1790 that his own name appears alone on plans for a building — for Government House, a design for the residence of the president of the United States.[29] Sometime during his apprenticeship, McComb visited Europe to study the important architectural sources of the day in England and France. The dates given for this European trip vary from 1783[30] to 1790,[31] but that he did take this tour and profit much by it in his professional development is evident in the work of his subsequent career as designer and builder.

Noting these years of sound apprenticeship and training, Professor Stillman comments that

These, in the main, were McComb's principal attributes as a designer-architect. His imagination and creativity, his advocacy and ready adoption of innovations, his sensitivity to proportion and design, his fineness and refinement, and perhaps less important, his skill of delineation were the features...in the formation of his style. His designer faculties manifested themselves not in his basic approach to architecture, however, which was fundamentally that of a builder-architect, but in its style. McComb...took, from the design books, established patterns which he then adapted to suit his needs. Like the master-builder of the eighteenth century, his inspiration was a tradition, not his own ingenuity. The patterns which he selected and the way in which he treated them, though, are what distinguished him as a designer....

The new style was transmitted to McComb...through architectural design books. McComb...owned the Works in Architecture of the Brothers Adam along with other interpretations of the style that Robert Adam had made famous. One of William Pain's many books and the Convenient and Ornamental Architecture of John Crunden were among these and Crunden, especially, had a profound influence on McComb. [32]

Professor Stillman has divided McComb's career into two parts or sequences, the first extending from 1790 to 1803. The Grange was the last structure he created in this formative stage. "The evolution of a style," comments Professor Stillman,

was the major production of McComb's early professional years, 1790-1803. In those thirteen years, the formative ones preceding his work on New York City Hall, the forces, created by the traditions of his father, the architectural handbooks, and the example of contemporary architecture, vie with the designer elements. Out of this interplay and the infusion of Adamesque design came a set style to which McComb remained steadfast for the remainder of his career. [33]

...He was a designer....He was a sensitive artist, and he was also a master builder. These three elements made up his style. Generally the last two were dominant, but occasionally McComb emerged as a designer. Yet, he had one basic flaw, even as a designer. Once his style had been formed, he could not, or would not, go far beyond it. [34]

In Professor Stillman's judgment, the Grange represents the maturing of McComb's architectural style. In addition, it is the only surviving, unaltered example of the domestic architecture of John McComb, Jr. It thus emerges as significant a three-dimensional document in the history of American architecture, as it is a representation of the life of Alexander Hamilton.

Both Hamilton and his architect were acquainted with the mansions of their friends in the Harlem area, which was at that time a most fashionable suburb of the city. Both were well acquainted with the Morris house, later to be called the Morris-Jumel Mansion, which still stands at 160th Street and Edgecombe Avenue. There is a feeling of spaciousness inherent in this house, of simplicity combined with a taste of fine ornamentation, of grandeur with little ostentation — all in a country setting with a good view of the rivers. These must have seemed to Hamilton vital to a satisfactory country house.

The Morris-Jumel house also incorporates a number of archways (see Illustration 7) and an octagon room (Ill. 8) — specific design features that later would appear in the Grange. These elements were well-represented in country houses of the affluent in early Federal America. It is likely that the designs for both the Morris-Jumel Mansion and the Grange were inspired by the same Federal aesthetic, with the earlier house exerting specific influence upon the design of the later one, because of their geographical proximity.

Illustrations 9 and 10 — McComb designs for structures in 1790 and c. 1799 — show the predilection of the designer for combining diverse room shapes and other design elements, themselves pleasing as units, into a pleasing composite design. They also illustrate two instances in which he chose unusual room shapes that fit together admirably to create a particular design.

These drawings were done during the period indicated by Professor Stillman as McComb's period of style formulation.[35] He was approaching the point of his design maturity as the Grange was being built. During this time, McComb became the master builder for the New York City Hall.[36] His work on the city hall was "the culmination of his development, the apogee of his style." [37] His building of the Grange marked a sharp point of departure. Afterwards, McComb designed few houses, working almost exclusively on churches and public buildings for the remainder of his career.[38] (He retired from active practice in 1826.)

Concerning the earlier period of the architect's creativity, 1790-1803, Professor Stillman comments that

In his country house designs, McComb's imagination and penchant for the Adamesque fashions were more rampant. The projecting areas, first conceived at Government House, became a consistent feature of his large free-standing houses. Most of this must, again, be inferred from the drawings, many of which are unidentified, for there is a rarity of existing dwellings of this type by McComb, as well. One definitely documented house, the Grange, still stands, though somewhat altered... Though his country residences are much more variable than his town houses, there is still a basic similarity to most of them. Essentially rectangular with protrusions, they are almost all variations on a specific concept of the house. Therefore, let us turn to the Grange for an investigation of McComb's work in this field. [39]

There is at present no identified set of plans or elevation drawings for construction of the Grange.[40] That the house was built from executed plans and elevation drawings is evident from the correspondence between Hamilton and General Schuyler, during July and August 1800, quoted earlier. A plan or elevation labeled "Hamilton's Country House" was recalled clearly by a few architects and historians, who remembered seeing the document 50 years or so ago, and who made note of their observations. In an issue of The White Pine Series, Lemuel H. Fowler wrote that

Fiske Kimball in discussing the "Grange" in his recent (and remarkably satisfying) American Domestic Architecture of the American Colonies and the Early Republic, apparently accepts McComb's connection as designer of this house on the evidence of the "Life." [41] He may, also, have seen in the McComb Collection in the New-York Historical Society, a plan marked "Hamilton's Country Seat" which I have an indistinct recollection of having seen among the McComb papers.... [42]

This reference, and a good measure of corroboration, was brought to this writer's attention by consulting architect Newton P. Bevin, to whose attention it was referred by Rawson W. Haddon, director of the Mattatuck Historical Society in Waterbury, Connecticut. Haddon studied this collection with Fiske Kimball when they were considering coauthorship of a biography of McComb many years ago. [43] Consequently, such plans and elevations for construction of the Grange — done by McComb — are presumed to exist, and the search for them continues. At this time, however, the construction of the house must be deduced from other materials.

In keeping with McComb's custom of adapting a design from one of the design books to suit the purposes of his current commission, it appears that the Grange plan was adapted from a design for the left-hand terminal pavilion planned for Kedleston Hall (Ill. 11). This appeared in part II of James Paine's Plans, Sections, and Elevations of Noblemen and Gentlemen's Houses, published in London in either 1768 or 1793. [44] Describing his pioneering efforts to determine the basis for the theme and variations in the Grange design, Professor James G. VanDerpool has written that he himself had

examined the 18th century American architectural publications [in the Avery Library] without finding a prototype of The Grange plan. I then turned to English architectural books available at the time. [45] In James Paine's Plans, Sections and Elevations of Noblemen and Gentlemen's Houses...Part 2 Plate XLII published in London, 1793, I finally located a plan (the left hand pavilion at Kedleston Hall) basically so similar to The Grange...that I feel...that it was known to Hamilton and architect McComb, and that this plan was used in substance, with no important variation, for the second floor plan of The Grange. [46]

Utilizing the Kedleston Hall pavilion plan, Professor VanDerpool in 1955 designed a restoration second-floor plan for the Grange (Ill. 12). He did this before the structural fabric of the building was opened in a systematic way. Nevertheless, his plan "predicted" with a great deal of success what was found later. This is the best evidence for the theory that McComb used the pavilion plan as a model. The few areas in which VanDerpool erred were in the contour of the main stair, the original



Illustration 7. Influences on the Grange Design: Main Stair of the Morris-Jumel Mansion, before redecoration.



Illustration 8. Influences on the Grange Design: Octagonal Drawing Room of the Morris-Jumel Mansion.

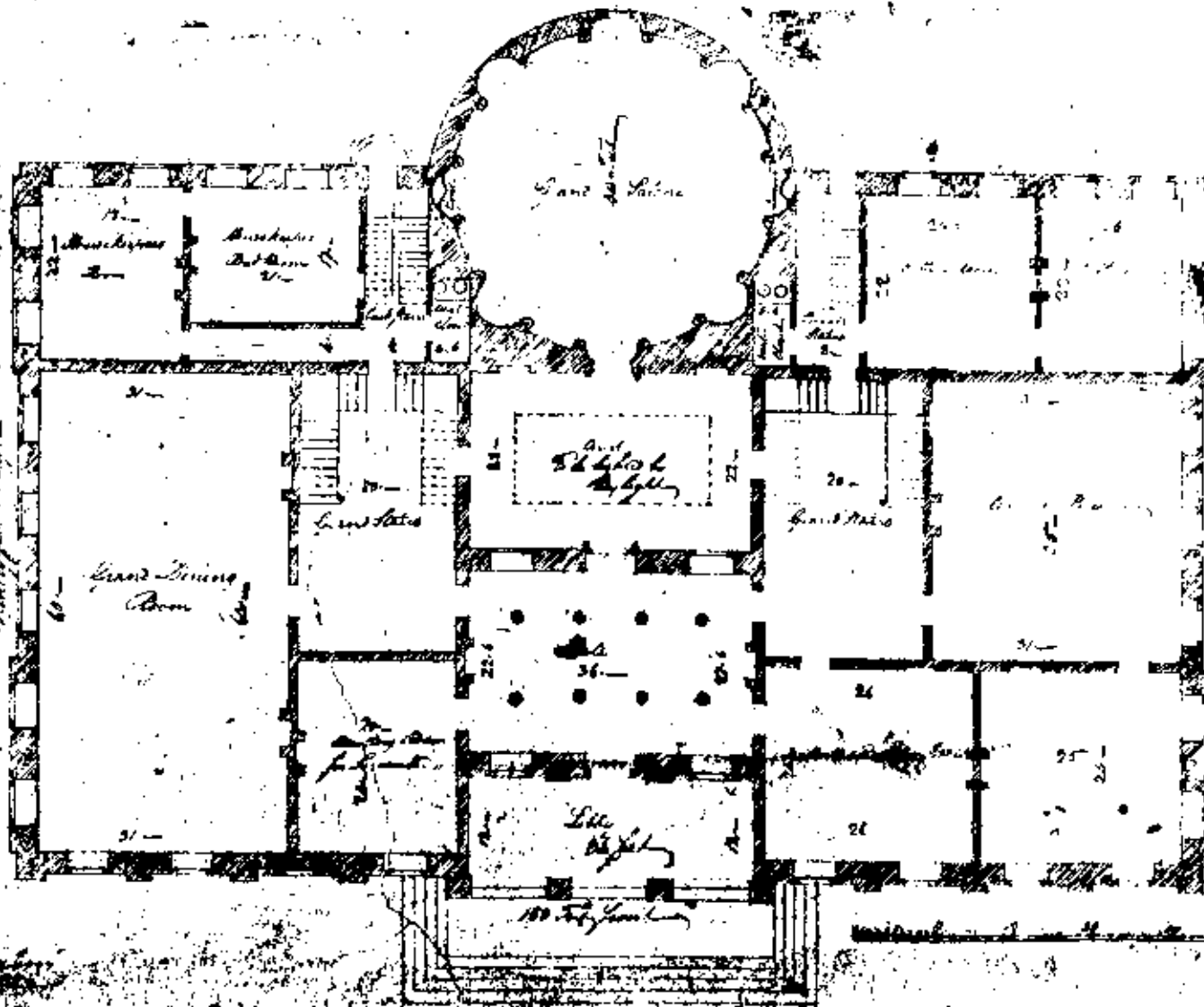

Illustration 9. Influences on the Grange Design: Plan for Government House, New York City, by John McComb, Jr. (1790).

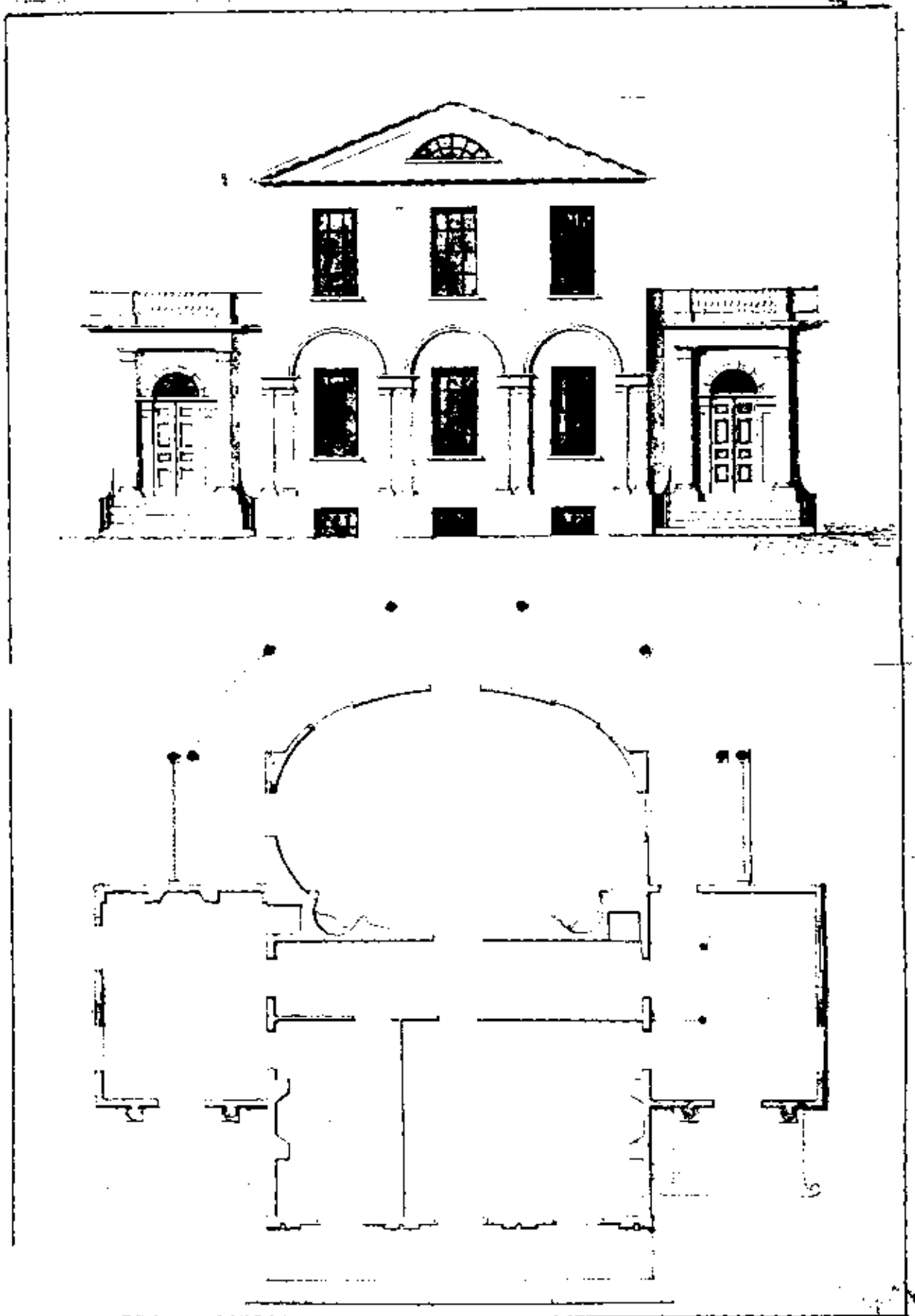

Illustration 10. Influences on the Grange Design: Plan for a Country House by John McComb, Jr. (c. 1799).

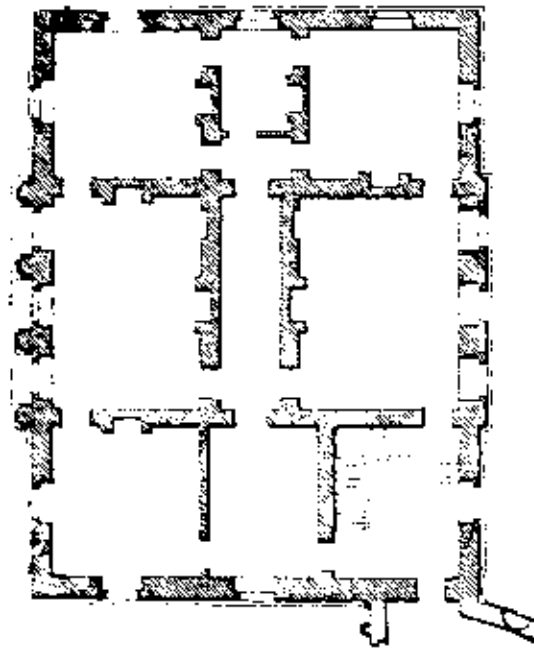

FIGURE 6. The plan of James Paine's left hand terminal pavilion at Kedleston Hall, Derbyshire, which appears to be the source for Macomb's original plan for Hamilton Grange

Courtesy Avery Memorial Library

Illustration 11. Sources of the Grange Design: Plan of the Left-Hand Terminal Pavilion, Kedleston Hall, Derbyshire.

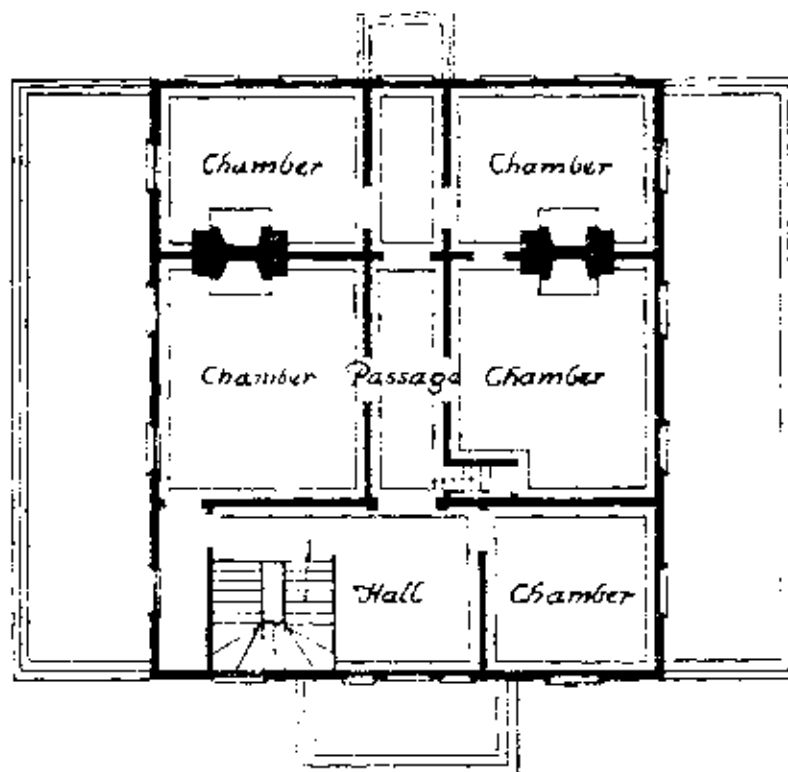

FIGURE 7. The second floor plan as restored

Courtesy American Scenic and Historic Preservation Society, and Francis Kelly

Illustration 12. Conjectural Re-creation of the Grange's Original Second-Floor Plan.

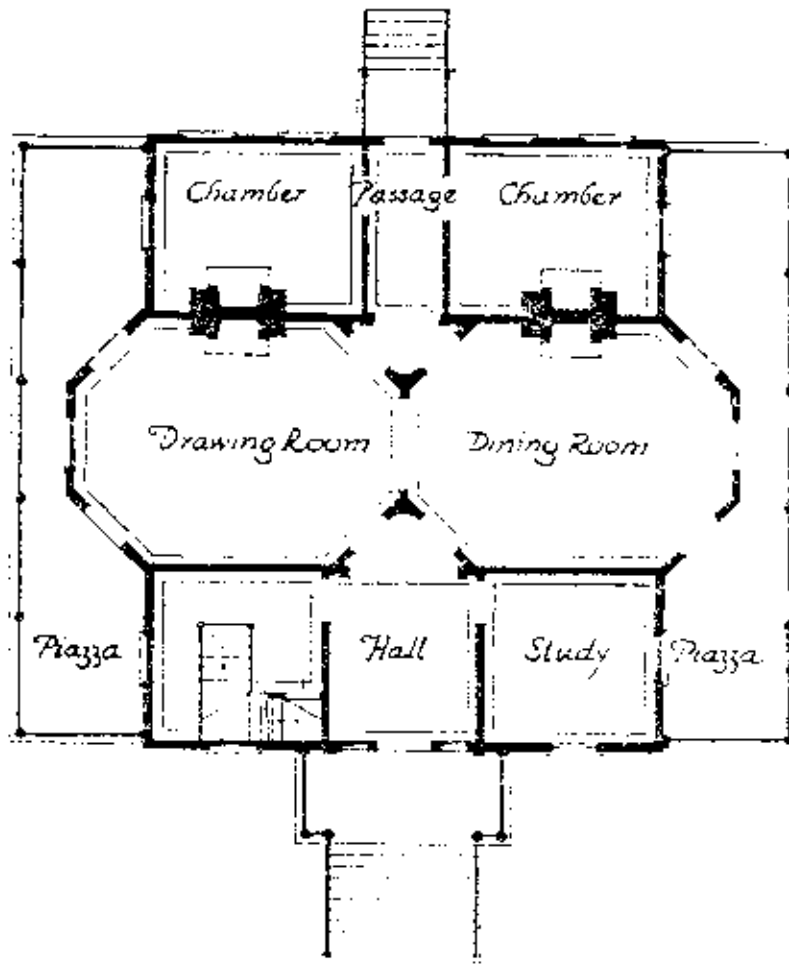

FIG. 41. 5. The main floor plan is recovered, with portions correctly located and the original entrance hall and stair hall reconstructed.

Courtesy, American School and Historical Preservation Society, and Francis Roberts

Illustration 13. Conjectural Re-creation of the Grange's Original First-Floor Plan.



Illustration 14. The Grange: Second-Floor North Hall, Cornice Continuing through Partition.

location of the attic stair, and the partitioning of the north rooms. The actual form of these details was determined only after structural investigation some 10 years later.

As for the first or main floor, Professor VanDerpool posited that

...a highly interesting and logical minor adjustment of the principal floor plan was made, namely that of eliminating the narrow central hall on the first floor, connecting the dining room and drawing room, and making each of these two rooms roughly octagonal in form. The center room [at the bottom] of the plan was readily made the entrance hall and the stairhall was moved from its right hand position to a corresponding location to the left.[47]

The first-floor "adjustment," or variation of the plan, is illustrated by another of Professor VanDerpool's drawings (Ill. 13). It errs only in its projection of the original width of the rear hall, and in the precise contour of the original stairs to the basement and to the second floor. Again, the accuracy that VanDerpool achieved by using the Kedleston Hall pavilion plan as a model seems to indicate that McComb used the plan himself.

VanDerpool was unable to apply the same method of analysis to the basement and to the cellar of the structure, since neither of these are original to the house.

McComb apparently drew upon the pavilion plan for inspiration, then, but he used his own imagination and skill to reshape the formal, almost awkward original design into one more suitable for actual living. The main way in which he did this was by combining several overly small rooms into larger, more comfortable ones. Thus, the plan's first-floor center hall was omitted, and its space redistributed among the surrounding rooms and halls to make them more spacious. And on the second floor, McComb eliminated the partition walls between the hall and the two rear chambers, creating one rectangular chamber across the entire back of the house. Such partition walls do exist today, and VanDerpool took them for original material. However, nail analysis indicates that these were added after Hamilton's death, probably around 1810-1820. Illustration 14 shows that the hall cornice and south-wall plaster continue uninterrupted underneath the partition walls; they do so from one side of the house to the other. (See the Architectural Data Section, Chapter III, Section D, "North Rooms" for more information about this situation.)

NOTES

1. Philip Schuyler to AH, July 17, 1800, AHP/LC.
2. "Bill from John McComb Junr. to Alexander Hamilton," Oct. 25, 1800, AHP/LC (Second Series, Vol. V, #22). See also S. Damie Stillman, "Artistry and Skill in the Architecture of John McComb, Jr.," p. 151.
3. "Bill from John McComb Junr. to Alexander Hamilton," Oct. 25, 1800, AHP/LC. See also receipts, William Bartin to AH and Ab[raham] Van Geld[er?] to McComb, Sept. 2, John Scot to AH, Sept. 18, 1800, AHP/LC.
4. Allan M. Hamilton, The Intimate Life of Alexander Hamilton, p. 210.
5. James Tod to AH, Feb. 25, 1800, AHP/LC.
6. David Hosack to John C. Hamilton, Jan. 1, 1833, AHP/LC.
7. Autograph document, signed by 31 individuals, including AH, in New York City Municipal Archive.
8. The N.Y. Journal, June 20, 1795, quoted in I.N. Phelps Stokes, The Iconography of Manhattan Island, V, p. 1321. See also Reginal P. Bolton, Washington Heights, Manhattan: Its Eventful Past, p. 61.
9. Stokes, Iconography, V, p. 1418.
10. AHP/LC.
11. Cornelia Schuyler, daughter of Philip Schuyler and wife of Washington Morton.
12. AHP/LC.
13. Hamilton, Intimate Life, p. 339.
14. Ibid., p. 256.
15. C.E. Gregg, "General Philip Schuyler and the Schuyler Mansion," Yearbook of the Dutch Settlers Society of Albany, Vols. XXV-XXVI (1949-1951), pp. 11-19; Mary Gay Humphreys, Catherine Schuyler, p. 1.
16. See, for example, Carl L. Becker, The History of Political Parties in the Province of New York, 1760-1776, pp. 8-10.
17. Gregg, "General Philip Schuyler," p. 12; Humphreys, Catherine Schuyler, p. 2.
18. Humphreys, Catherine Schuyler, p. 79.

19. John J. Vrooman, Historic and Scientific Sites of New York State, p. 15.
20. Gregg, "General Philip Schuyler," p. 12; Humphreys, Catherine Schuyler, p. 2.
21. Gregg, "General Philip Schuyler," p. 14; Humphreys, Catherine Schuyler, pp. 64-65, 76; Georgina Schuyler, The Schuyler Mansion at Albany, pp. 4-5.
22. Hamilton, Intimate Life, pp. 187-188.
23. Vrooman, Historic and Scientific Sites, p. 19.
24. Hamilton, Intimate Life, p. 339.
25. Stillman, "John McComb, Jr.," pp. 98-101.
26. Talbot F. Hamlin, "John McComb," D.A.B., XI, pp. 599-600; Stillman, "John McComb, Jr.," p. 7.
27. Ibid.
28. Hamlin, "John McComb," p. 599; Stillman, "John McComb, Jr.," p. 8.
29. Stillman, "John McComb, Jr.," pp. 8, 32.
30. "John McComb, Jr.," House & Garden, July 1934, p. 8h.
31. Hamlin, "John McComb," p. 599.
32. Stillman, "John McComb, Jr.," pp. 27-28.
33. Ibid., pp. 32, 48.
34. Ibid., p. 76.
35. Ibid., pp. 43-44.
36. Ibid., p. 6, and chapter V; Hamlin, "John McComb," p. 599; "The Original Plans of the City Hall, New York City, Drawn in 1802, John McComb, Jr. Architect," American Architect and Building News, XCIII, No. 1676 (Feb. 5, 1908), pp. 43-46.
37. Stillman, "John McComb, Jr.," p. 92.
38. Ibid., pp. 50-51.
39. Ibid., pp. 43-44
40. Ibid., p. 44.
41. "Life" here refers to Hamilton, Intimate Life.

42. Lemuel H. Fowler, "Some Forgotten Farmhouses on Manhattan Island," The White Pine Series of Architectural Monographs, IX, No. 1 (Feb. 1923), p. 7.

43. Rawson W. Haddon, director of the Mattatuck Historical Society, to Newton P. Bevin, Nov. 11, 1964.

44. Stillman, "John McComb, Jr.," pp. 44-45; James G. VanDerpool, "A Restoration Problem at Hamilton Grange," Columbia Library Columns, IV, No. 2 (Feb. 1955), pp. 11-23. Stillman cites Paine's publication date as 1768, VanDerpool as 1793. For additional commentary and illustrations concerning Kedleston Hall, see S. Damie Stillman, "The Sources of the Adam Style," pp. 336-337, 371, 376, 408, 429, 432.

45. For a basic list of such books, probably implemented since 1938, see Taibot F. Hamlin, House Plan Books Prior to 1890 in the Avery Library.

46. VanDerpool, "A Restoration Problem," pp. 19-20. According to the most complete information yet developed concerning books and other professional publications owned by McComb, it is not certain that he owned a copy of Paine's work himself, but he did possess a copy of The Works in Architecture by Robert and James Adam, which possibly also contained details of the Kedleston Hall pavilion. See Stillman, "John McComb, Jr.," p. 102, Item #2, and pp. 102-115.

47. VanDerpool, "A Restoration Problem," p. 20; see also Stillman, "John McComb, Jr.," p. 45.

IV. CONSTRUCTION

Plans for construction of the Grange were being drawn at the time that Hamilton formalized by deed his purchase of the original Grange tract on August 2, 1800. The plans were being prepared by John McComb, Jr., who is characterized as the "Architect Royal to the Federalist Party of New York." [1] The failure of General Schuyler's plan to have an Albany contractor build the house delayed the beginning of construction until the following summer, when the job was undertaken by McComb and Ezra Weeks. McComb submitted to Hamilton a "Proposal for finishing General Hamiltons Country House." This proposal, dated June 22, 1801, read as follows:

To Build two Stacks of Chimneys to contain eight fire-places, exclusive of those in Cellar Story

To fill in with brick all the outside walls of the 1st & 2d Stories, also all the interior walls that separate the two Octagon Rooms and the two rooms above them f[ro]m the Hall & other Rooms in both Stories—

To Lath & plastir the Side walls of 1st & 2d Stories with two Coats & set in white or prepared for [pain] ting or papering as General Hamilton may direct.

To Lath & plastir the Ceilings of 1st & 2d Stories with two Coats Set in White.

To Plaster the interior walls which separate the Octagon Rooms in both Stories, to be finished white, or as General Hamilton may Chose

To Lath & plaster all the other partitions in both Stories—

To Lath & plaster the Ceiling of the Cellar Story throughout—

To Plaster the Side walls of Kitchen, Ironing Room, Hall, passage, & to paint & white wash the Stone & brick walls of the other part of Cellar Story

To Point the outside walls of cellar Story, and to fill in under the Sills

To lay both Kitchen hearths with brick placed edgeways—

To put a Strong Iron back in the Kitchen fire place five feet long by 2 ft 9 inches high—

To put another Iron back in the Ironing Room 3'-6" by 2'-9"—.

To Place two Iron Cranes in the Kitchen Fire Place—& an Iron door for the oven mouth

The Rooms, Hall, passage of the First-Story to have neat Stucco cornices— Those of Octagon Rooms-of Best Kinds (but not inriched)

To put-up two Setts of Italian Marble in the Octagon Rooms, such as General Hamilton may chose —and Six Sets of Stone Chimney pieces for the other Rooms—

The Four fire places In the two Octagon rooms [and] the two rooms [adjoining] to have Iron Backs & jambs & four fire places to have backs only—

To Lay the foundations for eight-pieces for the Piazza—

Mr. McComb to find at his own expense all the Materials requisite for the above described work and to execute it complete in a good & workmanlike manner for One thousand Eight hundred & Seventy five Dollars—

General Hamilton to have all the Materials carted and to have all the Carpenters work done at his expense—General Hamilton is to find the workmen their board or to all [3] Shillings per day for each days work in lieu thereof

New York

22 June 1801

John McComb Junr

X To build the Stew holes in a wall in the Sink

X The whole to be compleated ~~the fourth of September~~ [sic] by [2]

All other construction would be undertaken by Weeks, a prosperous New York builder who constructed many important buildings of that period, several of them designed by McComb.[3] The day that Weeks began to dig the foundation is not certain. He probably started the work in the fall of 1801. His first receipt to Hamilton, in the amount of "Two hundred Dollars on account of his building," is dated December 2, 1801.[4] From that time through July 16, 1802, Hamilton made a series of payments to Weeks totaling \$1,596.83.[5] Weeks performed the heavy work of excavation and preparing the foundation for the main structure, as well as the rough construction of the house. McComb's contract was "for finishing the Dwelling House." [6] Weeks advanced his work sufficiently through the late winter of 1801-1802 that McComb began his part in May or June of 1802.[7] McComb's proposal for finishing the country house, dated June 22, 1801, substantially describes the finishing work as it actually progressed.

Beginning with the basement, or cellar, McComb's proposal provided first for finishing that story inside and outside. He was to:

1. Point the outside walls of the cellar story, and to fill in under the sills.
2. Plaster the side walls of the kitchen, ironing room, hall, passage, and to paint and white wash the stone and brick walls of the remainder of the cellar story.
3. Lath and plaster the ceiling of the cellar story throughout.

The only drawing of the original basement layout yet discovered is the one included in the 1888 alteration plans (see Illustration 15). It errs in two respects: the location, and most probably the configuration, of the basement stair. The original stair would not have been located under the front entrance hall. (The design is not that of the present stair, either.) Otherwise, the drawing appears to be an accurate representation of the original Grange basement. The layout follows basic architectural practice. With the first- and second-floor walls full of heavy brick nogging, the walls of the basement must have been positioned directly under them to provide adequate support.

In order to achieve a working kitchen and an ironing room, McComb proposed to:

1. Lay both kitchen hearths with brick placed edgewise.
2. Put a strong iron back in the kitchen fireplace five feet long by two feet, nine inches high.
3. Place two iron cranes in the kitchen fireplace — and an iron door for the oven mouth.
4. Build the stew holes in a wall in the sink.
5. Put another iron back in the ironing room three feet, six inches by two feet, nine inches.

McComb's proposals for finishing the first and second floors are equally illuminating. He would:

1. Fill in with brick all the outside walls of the first and second stories, and all the interior walls that separate the two octagon rooms and the two rooms above them from the hall and other rooms in both stories (thus adopting General Schuyler's suggestion).
2. Lath and plaster the ceilings of first and second stories with two coats, and set in white or prepare for painting or papering as General Hamilton directed.
3. Lath and plaster the ceilings of first and second stories with two coats set in white.
4. Plaster the interior walls that separate the octagon rooms in both stories, to be finished white, or as General Hamilton chose.
5. Lath and plaster all the other partitions in both stories.
6. Provide the rooms, hall, and passage of the first story with neat stucco cornices. Those of octagon rooms would be of the best kinds, but not enriched.

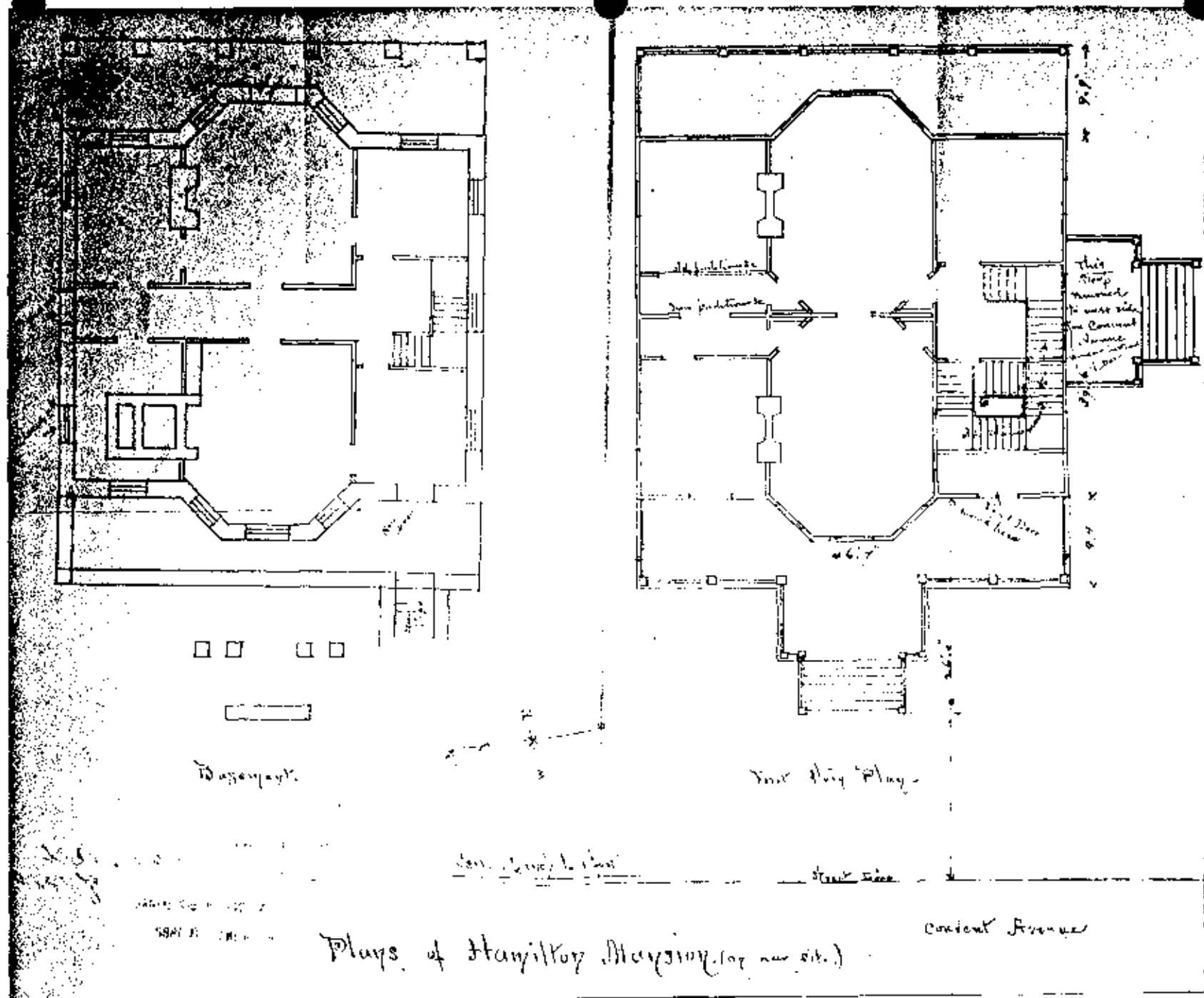

Illustration 15. The Grange: Basement and First-Floor Renovation and Alteration Plans (December 3, 1888).

Professor Stillman interprets these six proposals as following a characteristic pattern:

Whether the plainness of the interior of the Grange was due to economy or to the preference of either the client or the architect, we do not know. The sparseness of the interior decoration, though, is rather characteristic of the Federal age in America, and restrained delicacy within simplicity may well be the keynote of McComb's interior style, as well as that of many of his contemporaries. [8]

The fact that he eschewed elaborate detailing did not mean that McComb intended to produce a dull design, however. Instead, the architect sought to create interest via spatial dynamics. This he accomplished, by imaginatively reworking standard features and introducing new ones. For the transoms over the front and entrance doors, McComb borrowed and refined the fanlight of the entranceway pictured in Plate 39 of William Pain's Practical House Carpenter (Pl. 16). He then made a historic modification: he fitted the arched design into a rectangular frame. This innovation is detailed in Appendix F, sheets 1, 2 and 10; Appendix G, sheets 4, 8, and 10; and Appendix H, sheets 16 and 22. Thus, it seems that the square-headed doorway with sidelights and rectangular transom — so popular a motif during the Greek Revival period — made its first appearance in America at the Grange. [9] McComb and others used the design from time to time thereafter. His 1815-1817 design for Alexander Hall, Princeton Theological Seminary, contained an especially striking example of an entryway extending up into the second floor by means of a tripartite window (see Illustration 17). [10]

Another McComb hallmark evident at the Grange is the interior window casing of the double-hung windows in all but the two plainest rooms (Pl. 18). [11] This fenestration is detailed in Appendix G, sheets 7 and 9, and Appendix H, sheet 2.

McComb also reworked a familiar design for the main stairway from the first floor to the second. His model was the stairway at the Morris house, pictured in Illustration 7. The simplicity of the rail and balusters, and lack of wainscoting or other ornamentation, is in striking contrast to the stairways in most other town or country houses of this area in this period. Here again, McComb took a good design and adapted it to his particular needs. The Grange was designed to be smaller than most contemporary country houses, so McComb condensed the three-run stairway. (Although the configuration of the present-day stair is very different from the one McComb built, physical investigation has been able to determine the contour and dimensions of the latter. See the Architectural Data Section, Chapter III, Section C, "Entry and Stair Halls," for a complete description of the original stair.) To condense the stair, McComb altered the direction of the second run. Whereas the second run of steps in the Morris stairway ascends at a 90-degree angle from the first run, the Grange's second run makes a 180-degree angle with the first. In both the Grange and Morris stairways, the third run is at a 90-degree angle to the second.

The stairway, as originally constructed, occupied a room to the left of the main entrance. This room was entered through a doorway opposite to end balancing the doorway to the first-floor southeast room. Entering this door, the first flight of the stairway rose to the left.

At the second-floor level, the stairwell was open, to receive light from the tripartite window over the original main entrance. Along the edge of the hall overlooking the stairwell was a balustrade -- probably a continuation of the stair balustrade -- that ran into the south wall. (The physical evidence for this is documented in the Architectural Data Section.)

An example of how McComb employed new ideas can be seen in the design of the two formal parlors of the house. The use of octagonally shaped rooms -- rather than the elliptical ones found in some of McComb's earlier designs for New York City Federalists' houses -- appears to have been deliberate. The notion of utilizing octagonally shaped rooms for the formal chambers might well have been inspired by the success of the octagon room at the Morris house, [12] but it was the particular manner in which McComb utilized this shape at the Grange that gave unique distinction to the execution. During McComb's sojourn in Europe, the study of perspective -- and the effect of "La Nature a Coup d'Oeil" in such forms -- was stimulating development in many related fields, including art and architecture. This in time would result in the invention of the photographic plate.

McComb recognized the inherent possibilities of experimental shapes and optical techniques. (He understood the technical problem so well that some years later, he designed a structure specifically for the exhibition of cyclorama paintings. [13]) Thus, in his plan for the Grange's octagon rooms, McComb installed mirrors on the inner faces of the rooms' doors, to increase the amount of light and to bring images of the outdoors deep into the house. Moreover, McComb was well aware of the Grange's location, atop the spinal ridge of upper Manhattan. By utilizing back-to-back octagon rooms -- one facing the East River and the other the Hudson Palisades -- he obtained a view similar in feeling and superior in content to that seen from a present-day Fifth Avenue penthouse.

The cornices are substantially intact throughout the structure, except for modifications in the present entry and stair halls. Most of the cornice moldings are quite plain, and appear to have been executed as proposed. A more elaborate cornice in the octagon rooms appears to be the cause for an extra charge of \$30.00 made by McComb for "Inrichments for Cornice," noted later in this chapter.

McComb proposed, further, to:

1. Build two stacks of chimneys to contain eight fireplaces, exclusive of those in the cellar story.
2. Put up two sets of Italian Marble [chimney pieces] in the octagon rooms, as General Hamilton chose, and six sets of stone chimney pieces for the other rooms.
3. Install iron backs and jambs in the four fireplaces in the two octagon rooms and the two rooms adjoining, and install backs only in the four fireplaces on the second floor.

The "two stacks of chimneys" would be enclosed in two interior chimney housings rising through the rear of the side hips of the roof. The interior was designed so that the operating fireplaces in the cellar and on the first and second floors would be constructed directly above one another. The two chimneys rising from the rear of the

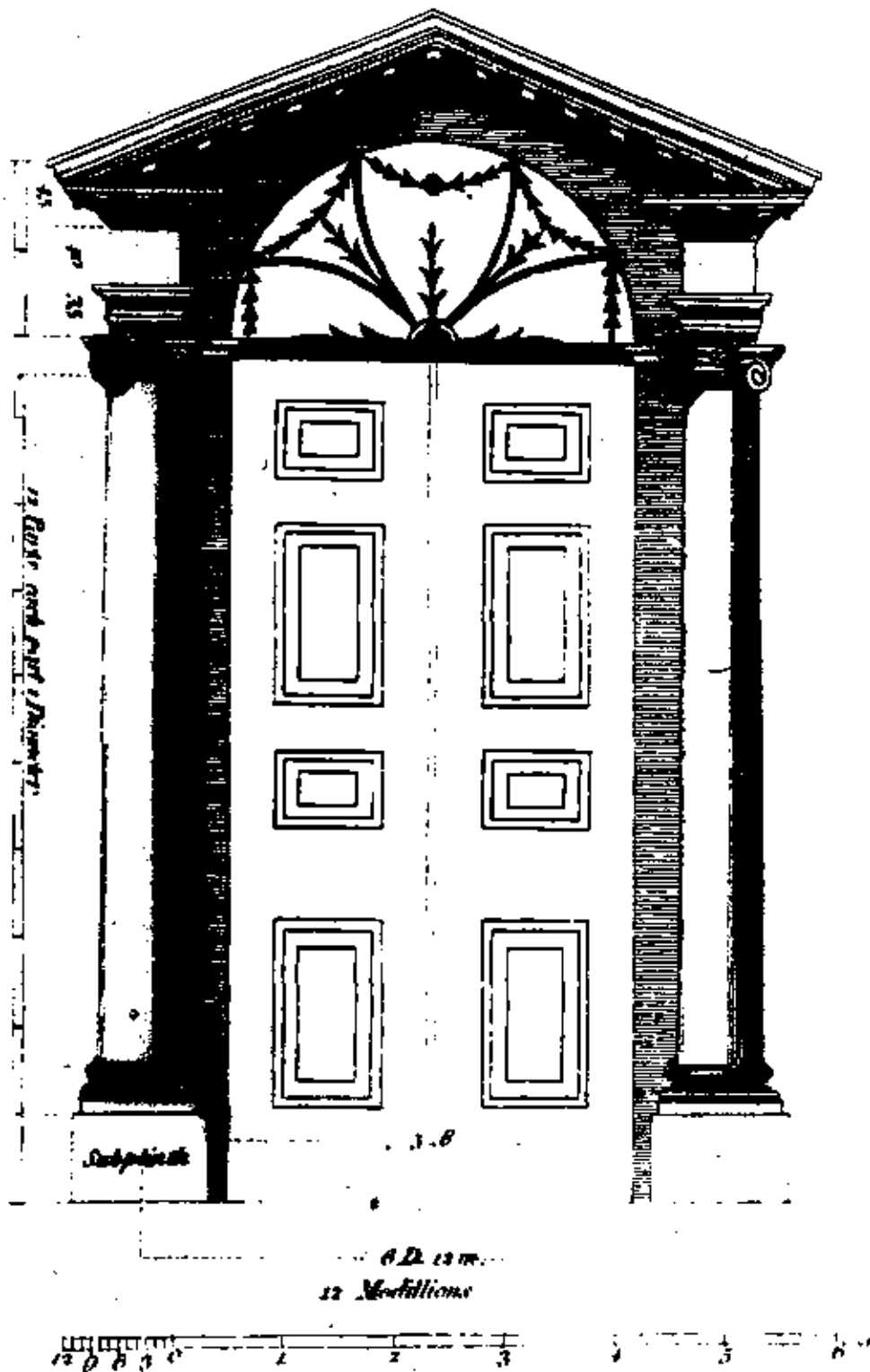

Published by Messrs. W. & A. G. & Co. by B.P. Co.

Illustration 16. Sources of the Grange Design: Doorway Fanlight.



Illustration 17. Post-Grange Designs by John McComb, Jr.: Alexander Hall, Princeton Theological Seminary, Princeton, N.J. (1815-1817).



Illustration 18. The Grange: Window Treatment, "Second-Best" Rooms.

roof unbalanced the design and disturbed the eye, so two false chimneys were erected in balancing positions on the front section of the roof, as illustrated in Appendix F, sheet 7.

Concerning the fireplaces and chimneys, the theories of Count Rumford, or Benjamin Thompson, appear to have been studied and adapted — for use in the Grange fireplaces and in construction of "stewholes," a form of early kitchen cookstove.[14] Fireplaces following the principles of Rumford's design tended to smoke less and throw out maximum heat from their firebacks. When Inspector General of the Army during the "quasi-war," Hamilton had been so impressed by the effects of Rumford's design that he had recommended to the Secretary of War that an abstract of Rumford's instructions, as simple and concise as possible, be sent to all commanding officers to be followed in garrison quarters.[15]

A major variation from McComb's proposal concerns the material of which the mantels were to be made. The mantels for the octagon rooms — proposed to be executed in Italian marble — and the six other mantels for first- and second-floor rooms — proposed to be of stone — were all actually done in wood. They were executed in matching pairs. All seem to have been of the same basic design, with varying amounts of ornamentation, depending upon the importance of the room in which each was used.

The least ornamented version of this mantel was used in the second-floor center rooms. Illustration 19 shows the one in the western room, which also features a later coal-burning grate. This is the basic Grange mantel, in both design and proportion. It is detailed in Appendix G, sheets 2 and 5, and in Appendix H, sheets 4 and 5. This mantel achieves something of an ultimate in simplicity and functionalism. The mantel in the second-floor east center room is identical.

Somewhat more ornate are the two matching mantels in the second-floor rear chambers, which originally were one long room across the entire width of the structure. Illustration 20 depicts the one in the northwest room, which is detailed in Appendix G, sheets 1, 3, and 9. Its companion mantel in the northeast room is detailed in Appendix H, sheets 8-12.

The four second-floor mantels just discussed are original, having been installed during the finishing work on the house. Four other mantels also were constructed and installed at this time, on the first floor — one in each of the octagon rooms, and one in each of the two north corner rooms at the rear of the house. Judging by the ornateness of the trim in the octagon rooms and the northeast corner room, the wooden mantels that were originally installed here were the most elaborately ornamented of all the Grange mantels. These were removed c. 1885 by the owner of the house at that time, as related later in this report, and replaced with the present granite mantelpieces. The plaster of the chimney breasts in both octagonal rooms retains the scars of the original wooden mantels, above the marble ones (see Illustration 21, arrow). The whereabouts of these original mantels has been traced up to a quite recent date, and they are presumed to exist. In design, they would be on the basic order of the second-floor mantels, but more ornate. They would be very similar to mantels that were created about 1799 for Gracie Mansion in New York City (see Illustration 22). In fact, the close resemblance between the extant Grange mantels and the basic design of the Gracie Mansion mantels seems to indicate that McComb may have been involved in the building of the latter structure as well.

The fourth missing mantel — the one originally installed in the northwest corner room — was probably much less ornate than the other three, judging by the trim in that room. It may well have been even simpler than the "basic" Grange mantel found in the second-floor center rooms. It most likely was lost when the fireplace here was closed up, perhaps in 1914, when this room was converted to a kitchen.

Following a policy of minimum incursions into the fabric of the structure until after it has been relocated, only one fireplace has been excavated to examine its structure. This is the fireplace in the first-floor northeast room. Illustration 23 shows the marble replacement mantel removed, and the plaster above it cut away to reveal the profile of the original McComb mantel. Found intact under the first layer of soot and plaster were a cast-iron fireback and jambs of the type proposed by McComb for the four fireplaces on the first floor. These are similar to plaster forms discovered in the Schuyler mansion at Albany. The opening in the wall to the right of the fireplace shows that at one time, there was a door between this room and the east octagon room. This is discussed in detail in the Architectural Data Section.

The only other elaborate decoration of the interior of the structure, aside from the mantels, occurs on the arch in the first-floor stair hall, where delicate leafage and bellflowers fill the keystone, pilaster capitals, and part of the shafts. This arch and its decoration is detailed in Appendix G, sheets 6, 11, and 12, and in Appendix F, sheets 25-29. The unadorned arches of the first-floor rear hall and the second-floor front hall are detailed in Appendix H, sheets 30-33.

The last item of work proposed by McComb was to lay the foundations for the supports for the "Piazzas" or covered porches at either side of the house. These porches and their foundations and supports are detailed in Appendix F, sheets 1-6.

It is also possible that the roof, piazzas, and front and back porticos were balustraded at this time. [16]

The outbuildings were east of the main house, down the slope, between the present Convent Avenue and Hamilton Terrace. Their location was recorded on a map drawn in 1819 (Ill. 24); in 1912, Edward H. Hall expanded this map (Ill. 25), to show where the buildings sat in relation to the modern street plan. Two branches of a brook draining toward the Harlem River — one branch flowing from where 140th Street is now, the other flowing from about 145th Street and Amsterdam Avenue — joined together at about Hamilton Terrace, where it was dammed into a little pond, probably for ducks. There was a spring house on one of these now vanished streams, for keeping butter and milk cool. The outbuildings also appear to have included a barn, shed, and chicken house.

At least some of the outbuildings were probably already in existence in 1800, in conjunction with the farmhouse. Either Hamilton renovated those already there to conform to his and General Schuyler's ideas for the ultimate development of the estate, or additional structures were built for the specialized functions required for life at the Grange. If a barn was constructed, it might have been patterned after a Schuyler barn that had required "50 Pitch Pine Logs of 50 feet Long 17 inches at the smallest end, etc.,..." [17] In the fall of 1801, Hamilton wrote from Albany to Mrs. Hamilton that her father

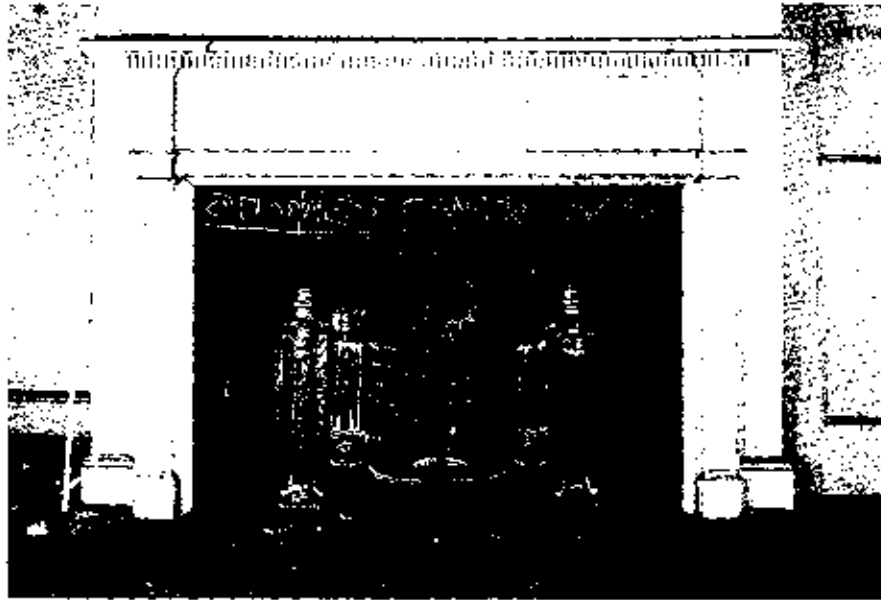

Illustration 19. The Grange: Original Mantel,
West Center Room.

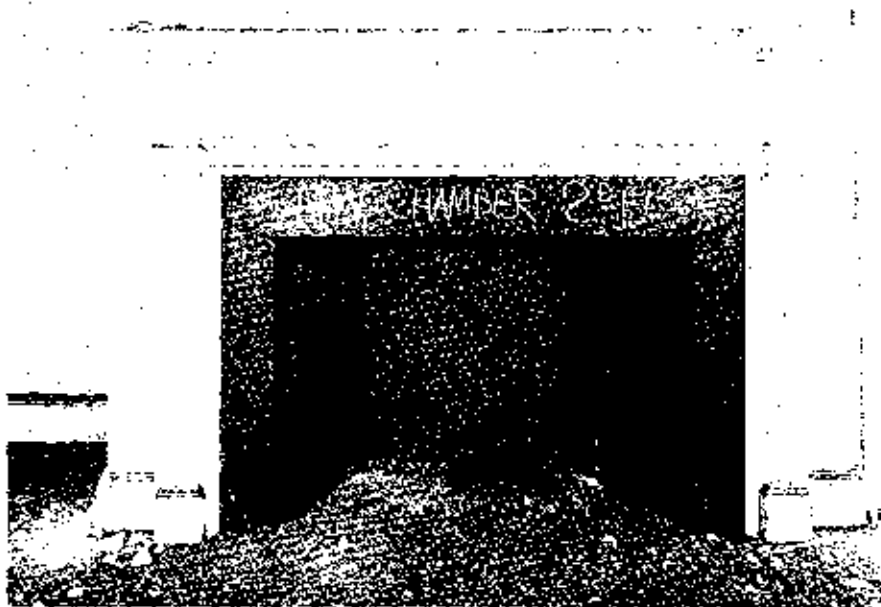

Illustration 20. The Grange: Original Mantel,
Second-Floor Northwest Room.



Illustration 21. The Grange: Replacement Mantel, West Octagon Room.



Illustration 22. Original Mantel, Gracie Mansion, New York City (c. 1799).

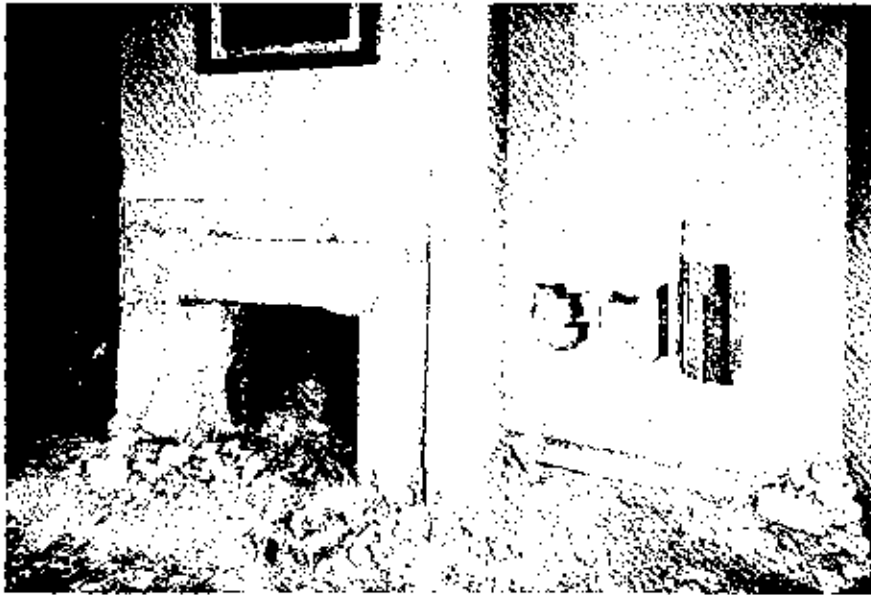

Illustration 23. The Grange: Investigation of Fireplace,
First-Floor Northeast Room.

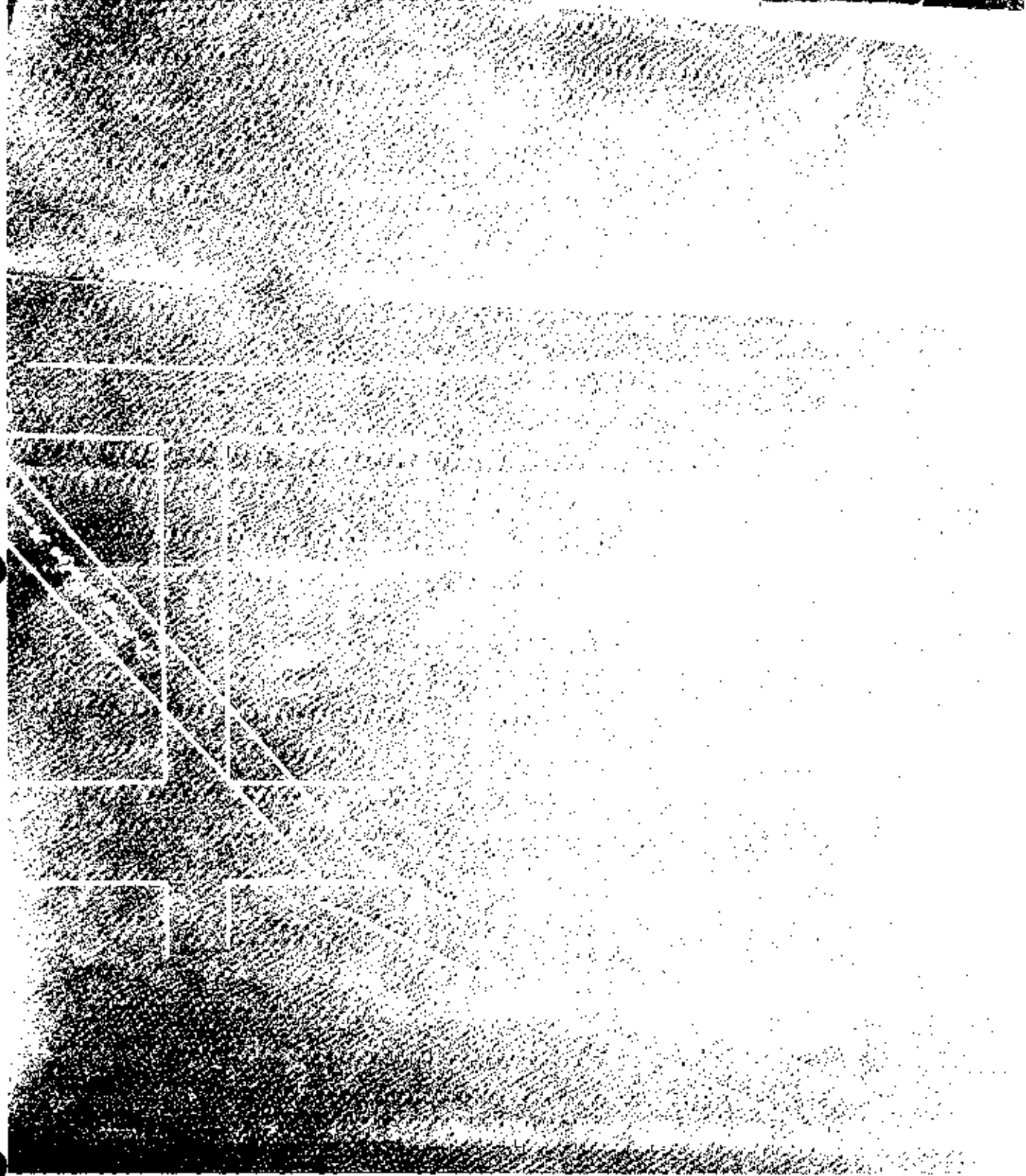

Illustration 24. The Grange and Its Outbuildings (1819), with Present Location and Street Plan Superimposed.

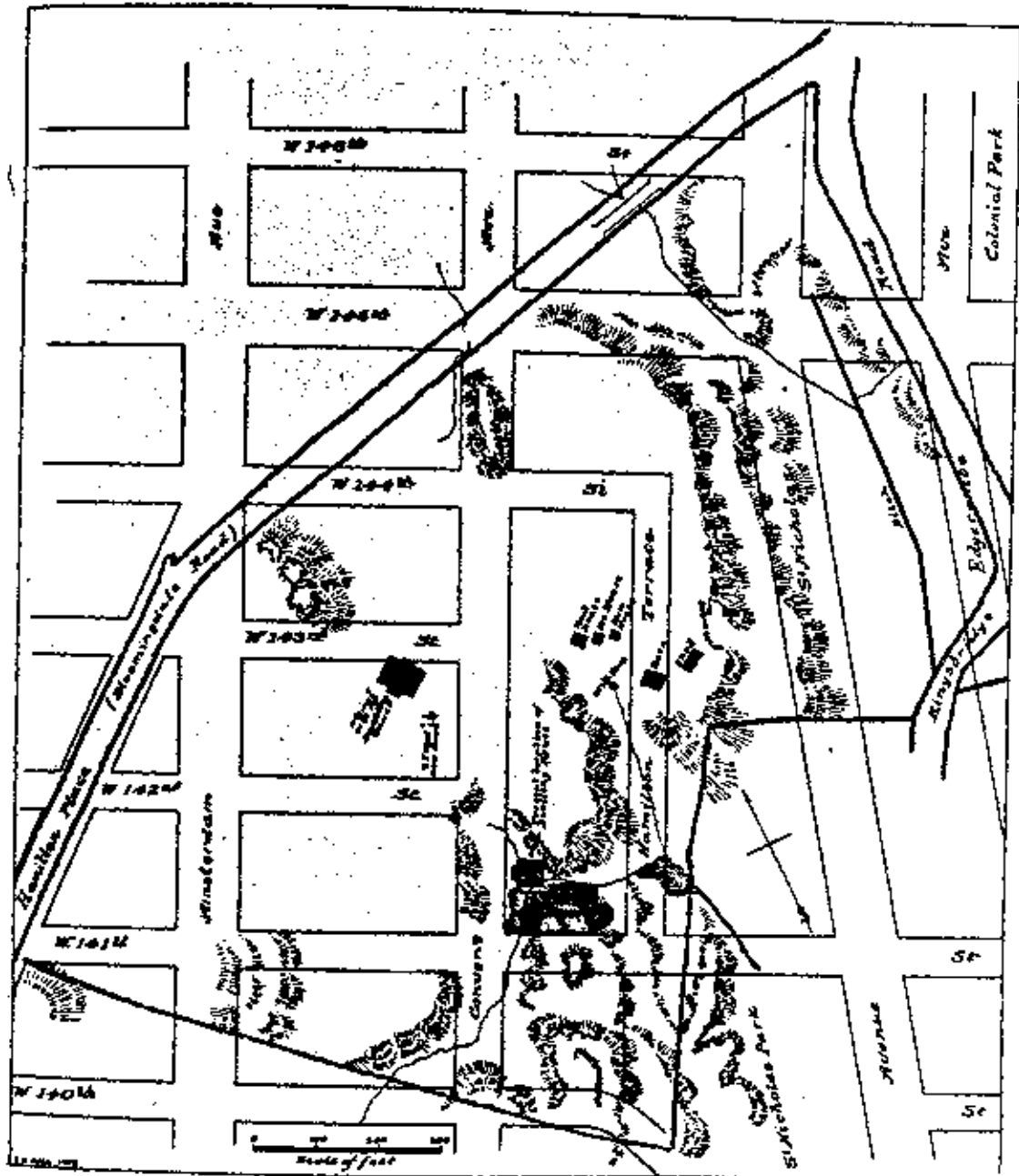

Plate 17. HAMILTON GRANGE. See page 147.
 Old farm lines and original site of building indicated on modern street plan.

Seventeenth Annual Report, 1912, of the American
 Scenic and Historic Preservation Society

Illustration 25. The Grange and Its Outbuildings (c. 1804), with Present Location and Street Plan Superimposed.

advises that the Ice house be shingled and with cedar shingles in preference. If not too late I wish to have it done. You need not be particular about the Cedar...[18]

Two years later the ice house was still unsatisfactory, and Hamilton again sent instructions to his wife for alterations, this time from Claverack on October 17, 1803:

...I wish the Carpenters to make and insert two Chimnies for ventilating the Ice-House, each about two feet Square & four feet long half above and half below the ground—to have a cap on the top sloping downwards so that the rain may not easily enter—the aperture for letting in and out the air to be about a foot and a half square in the side immediately below the cap...[19]

The cost of building the Grange can be figured with considerable confidence in the accuracy of the figure. The major contractor, Ezra Weeks, responding to an inquiry from Mrs. Hamilton in 1805, stated that

the amount of my account
for your house and improvement in
the country was £ 3729"18"9

N.Y. April 8 1805

[signed:] E. Weeks[20]

Converting this figure to the value of \$2.50 for each pound, \$.12-1/2 for each shilling, and \$.01 for each pence, Weeks received a total of \$9,324.85. Statements and receipts between Weeks and Hamilton from 1801 to 1804 trace Weeks' work and Hamilton's payments through this period, but these need not be reported in detail here, being part of the figure reported by Weeks himself.[21] One sample of this material, dated July 16, 1802, is Illustration 26.

No evidence has appeared that McComb received any fee for drawing plans for the house. For the work that he did in finishing the house according to his "Proposal," the basic contract price was \$1,875.[22] Under terms of the contract, "General" Hamilton was to stand the expense of specified extra costs, for which he was billed by McComb, as follows[23]:

1. Board:

750 man-days at \$.37-1/2 \$ 281.25

2. Added jobs:

Securing Cellar floor against rats	\$ 25.00
Paving the Cool Cellar	10.00
Ash House and 2 Iron doors, etc.,	14.00
Cess Pool	30.00
Rough Casting the foundation	13.00
Foundation for 8 Piers	8.00
Foundation for Stoops	8.00
Inrichments for Cornice	30.00

6&3/4 days mason work plastering necessary house and flagging milk house at \$1.62-1/2	10.96	
6-1/2 days mason setting grates, etc.,	10.56	
2 days mason taking down the kitchen range	3.25	\$ 162.77
 3. <u>Added wages:</u>		
24 days mason work at \$1.62-1/2	\$ 39.00	
26-1/2 days laborers work at \$1.00	26.50	
6-1/2 days labor at \$1.00	6.50	\$ 72.00
 4. <u>Added services:</u>		
Freight of the Lime	\$ 5.00	\$ 5.00
 5. <u>Added materials:</u>		
2 loads of stone for the carpenters	\$ 1.25	
3 casks lime	4.50	
2 casks lime	2.75	
20 loads stone	12.50	
1 cast iron plate for stew holes	7.50	
1 iron bar for ironing room chimney	1.00	
2 casks lime	3.81	
2 casks lime	3.25	
12 lb. nails for necessary house	2.00	
1500 lath for necessary house	2.25	
Shed and scaffold plank	20.00	\$ 60.81
	TOTAL . . .	\$ 581.83

Since he was twice delinquent in meeting progress payments to McComb, Hamilton paid interest on his account totaling \$38.37.[24] Thus, direct charges to Hamilton by McComb for work on the Grange summarize as follows:

As per contract	\$ 1,875.00
Total of extras under the contract	581.83
Interest for delinquent payments under contract	<u>38.37</u>
	TOTAL . . . \$ 2,495.20

The substance of this information appears in the documents reproduced as [Illustrations 27 and 28.[25] Of this amount, \$371.70 remained outstanding and was bound by Hamilton's note at the time of his death in 1804.[26]

Received of Alexander Hamilton in Account with E. Weeks
 1802
 for Freight of Board Materials up to May 27th 1802 By Cash ----- 120.00
 do do do do up to July 3^d 1802 197.13.11 July 3 Balance ----- 276.3.6
 do do do do of Boards ----- 3.13.00
 do do do do of Joists ----- 1.19.00
 do do do do of L^{ts} and Shingles 6.3.6
 do do do do of Trussers Bill of Fare & side lights 28.00.00

\$ 396.3.6
 July 3 To Balance ----- 276.3.6

\$ 396.3.6
 Received New York July 16. 1802
 Received of Alexander Hamilton Three
 hundred & forty six Dollars &
 03 Cents on account
E. Weeks
 The amount of Mr. A. B. Loshes Bill was credited on a Statement underd. by 15

Illustration 26. Statement of Account and Receipt, Ezra Weeks to Alexander Hamilton (July 3 and 16, 1803).

State of acc. between Gen^l Hamilton and
John McComb Jun^r

am^{ts} of contract for finishing
the Dwelling House ----- } \$1875-00

571 ds board asft. argument }
@ 3/- - (done last Year) - - } 214-

am^{ts} of extra work is uncertain
Doll^r 2089-

1802

6th

June 2 ^d	By Cash rec ^d -	\$ 400.	
July	By Cash -	400.	
Sept. 12 th	By Cash -	400.	
Dec ^r 8 th	By Cash -	150.	1350.

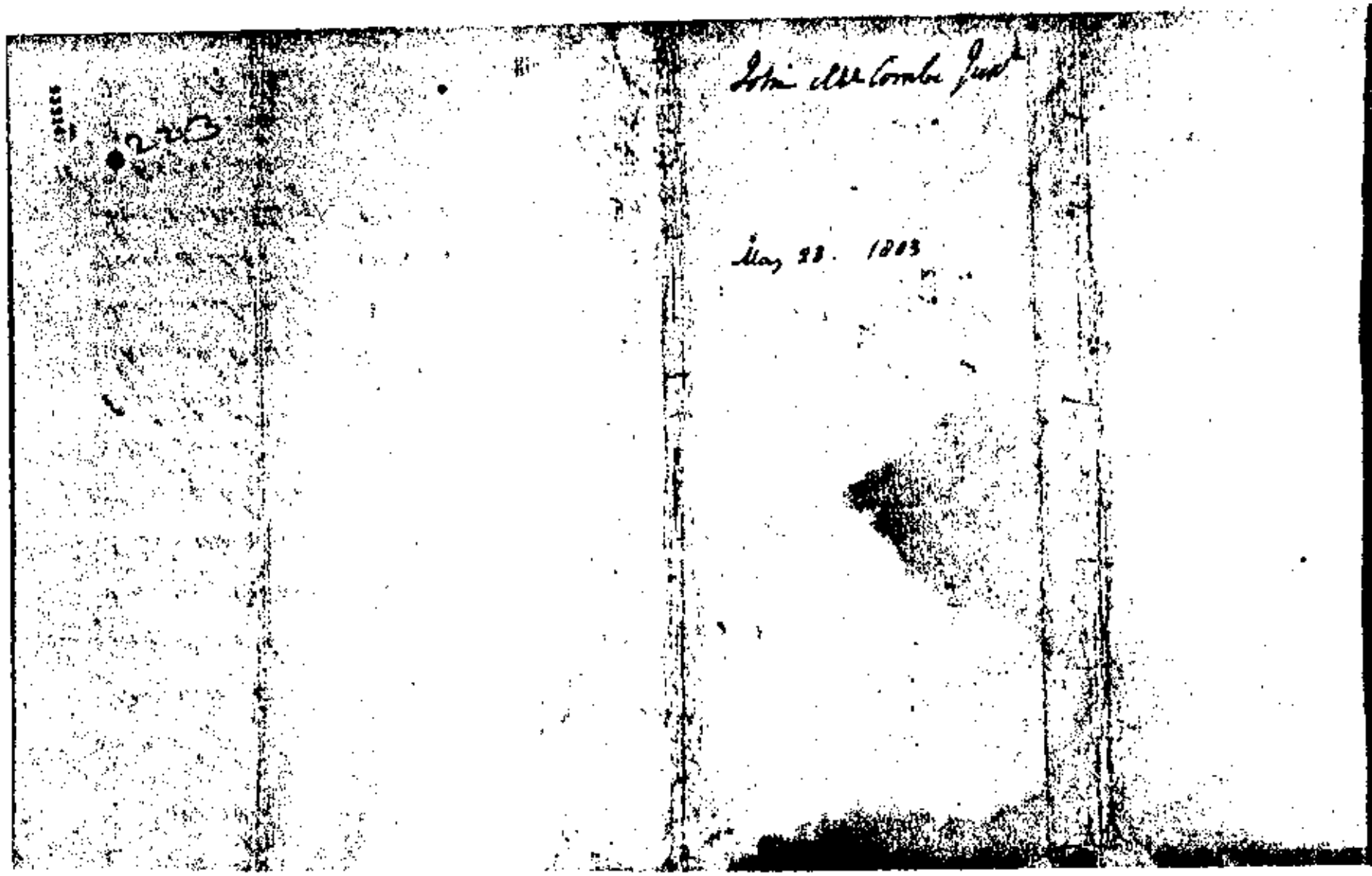

Illustration 28. "Final Account...", John McComb, Jr., to Alexander Hamilton.

July 1st to 25th 1867
503.33

595.00
250

Dr 345.10
26.70
~~99.04~~

July 25th to 31st 1867
Dr 371.70

Dr 371.70
~~103.44~~

received New York Markt 23. 1864 Received
of Alexander Hamilton his note for the
above Balance payable on the part of
himself what when paid will be on
part of all demands

John Elsbomb's Sure
(") (")

Hamilton Hamilton Avenue in Ave. South

1152	1/2 day for finishing house only	1875	1801	June 2 nd	By bank rec'd on
	at 10 Contract			July	cash
	750 days paid as payment	281.25	July 18		cash
	paying collar for aft. bats	25	Dec 6 th		cash
	had done had by the carpenters	1.25	1802	Apr 26	cash
	During the 600 th collar	10		30	
	the house and 2 iron doors &	14	July 23		cash
	cup door	30			
	Rough casting the foundation	13			62 1/2 dt Board
	Foundation for 3 Piers	8			Balance due Self
	Foundation for Stoops	8			
	Enrichments for cornice	30			
	3 Casks Lime	4.50			
	2 dt Lime	2.75			
	20 loads Stone	12.50			
	26 days Mason work	34			
	26 1/2 dt Labor	26.50			
	1 Cast Iron plate for New Hole	7.50			
	1 Iron bar for lining room about	1			
	length of the same	5			
	2 1/2 days mason work plastering	10.96			
	Necessary mason & flagging with				
	1 Cask Lime	3.50			
	2 dt Lime	3.25			
	12 dt Mason during Hatch 16	10.56			
	12 dt Labor	6.50			
	1 dt Labor	2			
	1 dt Labor for masonry	2.25			
	1 dt Labor taking down the	3.25			
		70			
		2556.50			

Hamilton Avenue in Ave. South

Hamilton's records reveal other expenses assigned to building the Grange:

1802

February	Pipes	\$ 47.00	
June	300 cedar posts by Capt. Browne	114.10 [27]	
June 28	House paint	118.00	
July 18	Blacksmith	9.66	
August	Carpentry	6.00	
August	Boards	56.25	
August	Cedar posts	30.00	\$ 381.01 [28]

Other expenses are assigned to construction at the Grange, without specifications:

1802

February		\$ 150.00	
June 1		25.00	
June 10		17.50	
September 15		235.00	
September 15		250.00	\$ 677.50 [29]

Several individuals received payments that appear to have been related to construction or materials:

1802

April 10	John B. Dash, Jr.	\$ 250.00	
June 23	Taylor	285.00	
June 28	Valentine Nutter	130.50	
June 28	Mr. Harris	50.00	
December 21	Jennings	100.00	\$ 815.50 [30]

Three men appear to have been working for Hamilton on a wage basis at the Grange during 1802, concerned mainly with its construction:

Thomas Costigan	at \$9 per month	\$ 108.00	
Andrew Malcom	March-Dec. at \$12 month	120.00	
William Tuff	Nov-Dec.	50.00	\$ 278.00 [31]

In 1802, New York City appraised the Grange at \$5,500 valuation, and levied a real estate tax of \$11.55. [32]

In summary, the cost of the Grange at the time of its completion was:

Schieffelin, for the ground		\$ 4,000.00
Ezra Weeks, contractor		9,324.85
John McComb, Jr., architect-contractor		2,495.20
Miscellaneous expenses	\$381.01	
	677.50	
	815.50	
	278.00	
		<u>2,152.01</u>
		\$17,972.06

The cost to Hamilton of his grounds and building was \$17,972.06. This figure excludes an evaluation of the lumber donated by General Schuyler, which would have raised further the cost of construction.[33]

NOTES

1. S. Damie Stillman, "Artistry and Skill in the Architecture of John McComb, Jr.," pp. 95-96.
2. John McComb, Jr., to AH, AHP/LC (folio #93302-93303, Second Series, 1917). Compare Allan M. Hamilton, The Intimate Life of Alexander Hamilton, pp. 341-342; AS&HPS, "The Building of the House," Thirtieth Annual Report (1925), pp. 22-24.
3. Hamilton, Intimate Life, p. 185.
4. AHCB, II, AHP/LC.
5. Ibid.; folio #93304, AHP/LC.
6. "State[ment] of acc[ount] between Genl. Hamilton and John McComb Jun[ior]," Dec. 8, 1802, AHP/LC.
7. Ibid.
8. Stillman, "John McComb, Jr.," p. 47.
9. Lemuel H. Fowler, "Some Forgotten Farmhouses on Manhattan Island," The White Pine Series of Architectural Monographs, IX, No. 1 (Feb. 1923), p. 7; Stillman, "John McComb, Jr.," pp. 23-24; Agnes Rothery, Houses Virginians Have Loved, fig. 76.
10. Stillman, "John McComb, Jr.," pp. 69-71.
11. Ibid., pp. 22-25.
12. I.N. Phelps Stokes, The Iconography of Manhattan Island, V, p. 1202; see also pp. 1193, 1226, 1263, 1269. See also William H. Shelton, The Jumel Mansion, p. 136.
13. John McComb, Jr., Drawing #197, N-YHS; Stillman, "John McComb, Jr.," p. 183, fig. 47.
14. "Plan of a Chimney on Rumford's Principles," PAHPP; Hamilton, Intimate Life, pp. 342-343; Broadus Mitchell, Alexander Hamilton: The National Adventure, 1788-1804, pp. 500-501.
15. Mitchell, The National Adventure, pp. 500-501.
16. Stillman, "John McComb, Jr.," p. 44.
17. Mitchell, The National Adventure, p. 500.
18. AH to EH, Oct. 4, 1801, PAHPP.

19. PAHPP.
20. AHP/LC.
21. See entry for July 16, 1802, PAHPP; folio #93304, AHP/LC; AHCB, II, Dec. 2, 1801, Feb., Mar. 31, May 1, 12, 27, July 18, Oct. 24, 1802, Jan. 6, Mar. 1804, AHP/LC.
22. "State[ment] of acc[ount] between Genl. Hamilton and John McComb Jun[ior]," Dec. 8, 1802, AHP/LC; entry for Dec. 8, 1802, PAHPP; "Final Account of Alexander Hamilton with John McComb, Junr.," May 23, 1803, AHP/LC.
23. "Final Account of Alexander Hamilton with John McComb Junr.," May 23, 1803, AHP/LC (Second Series, V, p. 498, 3 sheets).
24. Ibid., sheet 3.
25. See AHCB, II, Feb. and May 1802, June 14, 1804, AHP/LC.
26. "Final Account of Alexander Hamilton with John McComb Junr.," May 23, 1803, AHP/LC (Second Series, V, p. 498, 3 sheets).
27. Credited to "Tuition & Board" of grandson of the Rev. Mr. Moore, AHCB, II, AHP/LC.
28. AHCB, II, AHP/LC.
29. Ibid.
30. Ibid.
31. Ibid.
32. 1802 Harlem Tax Book, Office of the Director of Finance, City of New York.
33. Mitchell, The National Adventure, p. 500; Hamilton, Intimate Life, p. 140; Martha J. Lamb, "Historic Homes and Landmarks: Their Significance and Present Condition," Magazine of American History, XXI, No. 1 (Jan. 1889), p. 6.

V. LIFE AT THE GRANGE

Construction of the new Hamilton country house was advanced enough by early August 1802 such that the family could move in. The remaining work was completed by February 1803.[1] The appearance of the house at that time is suggested by Illustrations 29-31, which are unsigned but purportedly based upon measured drawings done by the City Architects' Emergency Committee and dated March 2, 1933 (Appendix F). These renderings are generally accurate, with the following exceptions: Illustration 29, window shutters and peaked roof line; Illustration 30, window shutters and contour of main stair in plan; and Illustration 31, contour of main stair in plan. Of particular interest is the fact that this latter plan depicts the north rooms correctly as one large room -- some 30 years before physical investigation proved this to have been the case.

Upon moving into the new house, Hamilton fulfilled another of his desires, by calling it the "Grange" -- the name of an estate of his paternal Scotch ancestors.[2] The first proof of residency is a letter from Hamilton to Oliver Wolcott, which began

Grange

Aug. 14. 1802

and was signed with his characteristic

A Hamilton

Another early letter by Hamilton sent from the Grange carries the date of September 19, 1802.[3]

Since the property purchased for the Grange estate was a compromise between Hamilton's desire for Hudson River frontage and the land available to him, the master of the Grange quickly undertook -- in his characteristic manner -- to improve his holdings. Less than two months after the purchase of the first section of the Grange property, he added a contiguous parcel: in September 27, 1800, he purchased the three-acre strip of land along the northeast border of the Grange property, extending from the Bloomingdale Road to the Kingsbridge Road.[4] Vendors were Samuel and Mary Bradhurst. Consideration was \$750.[5] As had been the case with the original parcel of land purchased for the Grange estate, this transaction was not recorded at that time. Still later, a third section of land was purchased, to complete the Hamilton estate. This third parcel, contiguous to the second, completed a triangle whose base was the original Grange property and whose two sides were the Bloomingdale Road and the Kingsbridge Road. This parcel also was purchased from the Bradhursts, by terms of an agreement dated January 10, 1803.[6] It appears that this final section of the Grange property comprised in excess of 14 acres. The two purchases from Bradhurst, added together, totaled 17 acres, 2 roods, 10 perches.[7] The Grange estate, as its boundaries were known to Alexander Hamilton, is mapped on Illustration 25. This shows the modern street system and the 1899 relocation site superimposed upon the Grange property as assembled by Hamilton.

Much romantic speculation has been published about Hamilton's love of the soil and his desire to spend considerable time at gardening and farming. The time that he actually had available to spend personally at these pursuits was minute. His bucolic activities were primarily vicarious, and even in this there was no profit.[8] As a complete realist, Hamilton never deceived himself on this score. He referred to the Grange as his hobby.[9] He wrote to Mrs. Hamilton in 1801 that

Received of Alexander Hamilton in Account with E. Weeks $\frac{1}{2}$
 Balance of old materials and postage 158.16.1 May 27th By Cash ----- 120.00
 Balance of work & materials up to July 3rd ----- 197.13.11 July 3 Balance ----- 276.3.6
 Paid Mitchell & Co of Boards ----- 3.13.00
 Paid & credited Bill of Joists ----- 1.19.00
 Paid & credited Bill of Lumber & Shingles ----- 3.6
 Paid & credited Bill of Hand side lights 28.00

 \$ 396.3.6
 From
 July 3 Balance ----- 276.3.6

 Received in New York July 16. 1803
 Received of A. Hamilton Three
 hundred & Ninety Six Dollars
 & 03 Cents on account
 E. Weeks
 The amount of Mr. A. B. Lishes Bill was credited on a Statement rendered May 15

Illustration 26. Statement of Account and Receipt, Ezra Weeks to Alexander Hamilton (July 3 and 16, 1803).

State of acc. between Gen^l Hamilton and
John McComb Jun^r

am^{ts} of contract for finishing
the Dwelling House ----- } \$1875-00

571 dr board apt. agreement
@ 3/- - (done last Year) - - } 214-

am^{ts} of Extra work is uncertain
Doll^r 2089-

1802

6th

June 2 ^d	By Cash rec ^d	\$ 400	
July	By Cash	400	
Sept. 12 th	By Cash	400	
Dec ^r 8 th	By Cash	150	1350

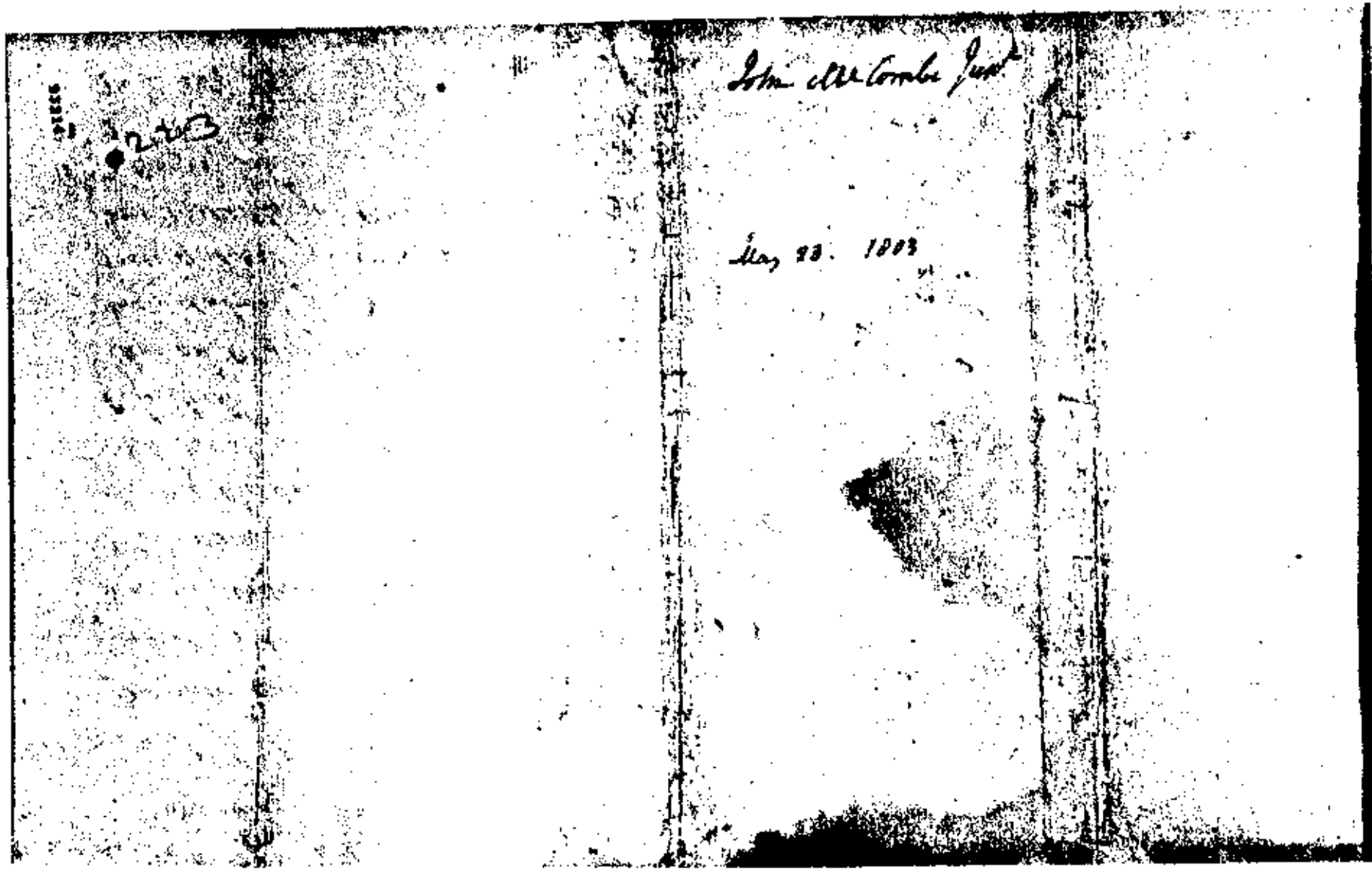

Illustration 28. "Final Account...", John McComb, Jr., to Alexander Hamilton.

	503.33
	11.67
	<hr/>
	595.00
	250
	<hr/>
	345.00
	26.70
	<hr/>
	371.70
	<hr/>
	103.42

July 10 1884
 D^r 371.70

Received New York Mowl 23. 1884 Received
 of Alexander Hamilton his note for the
 above Balance payable on the part of
 June next what when paid will be in
 full of all demands
 John M. B. ...
 " " "

Meranda Hamilton's account in Ar. 1875

100	1/2 cent for finishing house at	18.75	1301	By Cash received on
	Wilmingtondale as per contract		June 2	July
	750 days board as per agreement	281.25	July 13	July
	Measuring collar from aft. Deck	25	July 6	July
	2 bed stone laid by the Carpenters	1.25	1302	July 26
	Unraveling the 6000 Collar	10	July 30	July 23
	1/2 bed stone and 2 iron doors & cap work	11		July 23
	Through casting the foundation	30		62 1/2 at Board
	Foundations for 3 Piers	8		Balance due S. & B.
	Foundations for No. 4's	8		
	Improvements for cornice	30		
	3 casks lime	4.50		
	2 casks lime	2.75		
	20 loads Stone	12.50		
	26 days Mason work	39		
	26 1/2 days laborers	26.50		
	1 cast iron plate for sea hole	7.50		
	1 iron bar for lining room ahead	1		
	Weight of the same	5		
	2 1/2 days mason work blasted by	10.75		
	measuring house & flagging with			
	2 casks lime	3.25		
	2 casks lime	3.25		
	20 days labor during heated	10.50		
	20 days labor	6.50		
	2 days labor for measuring	2		
	2 days labor for measuring	2.25		
	2 days labor for measuring	2.25		
	20			
	Total	2456.50		

New York 10th February 1875

...Wife Children and hobby are the only things upon which I have permitted my thoughts to run. As often as I write, you may expect to hear something about the latter. [10]

Thus, Hamilton was more of a vicarious gardener than an actual one. He was forever on the move, tending to his professional practice and business interests. But wherever and whenever he traveled, or even when he stayed overnight in lower Manhattan, he wrote to his "Betsy." And he sent instructions or queries in practically every letter. The range of the thoughts and ideas expressed about the property and its management appears in excerpts from some of his letters:

...Don't lose any opportunity which may offer of ploughing up the new garden spot and let the waggon make a tour of the ground lately purchased to collect the dung upon it to be scattered over that spot.

When it is too cold to go on with grubbing, our men may be employed in cutting and clearing away the underbrush in the Grove and the other woods; only let the center of the principal wood in the line of the different rocks remain rough and wild.

The Country people all agree that to fat fowls, it is essential to keep them well supplied with gravel. One, of whom I inquired, informed me, that sea shore gravel, not too large, is particularly good. They also say the coops must be cleaned out every two or three days. After the Fowls have had a sufficient opportunity of drinking, the remaining water must be removed. [11]

...Dumphy had planted the Tulip Trees in a row along the outer fence of the Garden in the wash and was collecting Some Hemlock Trees to plant between them. I desired him to place these in a row along the inner fence.-I mean the side nearest the house. But having attended to them in my route, I Shall be glad, if White Pines are not conveniently to be had, that besides those along the inner fence there may be one Hemlock between every two of the Tulip Trees along the outer fence. [12]

...It has always appeared to me that the ground on which our Orchard Stands is much too moist. To cure this a ditch around it would be useful, perhaps with a sunken fence as a guard....

If you can obtain one or two more labourers, it may be advisable to cut a ditch round the Orchard three feet deep by three feet wide at the bottom. The clay that comes out of the Ditch will be useful to give firmness to our road and may be used for this purpose.

...confide this merely as a suggestion.... [13]

These are but a few of the numerous references to matters concerning development of the Grange estate grounds that cropped up in the steady stream of correspondence between Mrs. Hamilton and her continually traveling husband. The most concise description of the grounds is given in a letter from Hamilton to Judge Richard Peters, who was a well-known practical farmer and writer on agricultural subjects: [14]

...The greatest part of my little farm will be dedicated to Grass. The soil is a sandy loam, in which there is rather too large a dose of Sand. Yet every thing has hitherto thriven well.

What will be my best plan as to the raising of Grass and what kinds ought I to prefer; and what season for sowing the seed?...

It has been mentioned to me that you have in your quarter a species of red clover, the stock of which is less coarse than ours, and the quality very good. If this be so, and you think well of it, you will oblige me by procuring & sending me a couple of baskets of the seed.... [15]

It was in this same letter that Hamilton expressed his oft-quoted garden soliloquy:

A disappointed politician you know is very apt to take refuge in a Garden. Accordingly I have purchased about thirty acres nine miles from Town, have built a house, planted a garden, and entered upon some other simple improvements. [16]

Peters responded at length on January 8, 1803:

...I am glad you have this little Syren to seduce you from public Anxieties. But take care that the meretricious charms of this new Flame does not make too great Drafts in your Purse....Make your little Farm your Plaything, but see that you have other Business., that you may afford to pay for the Rattle....I should be very happy to give you Instructions, in one of the few subjects you do not know better than I do....

If you dedicate your Farm to Grass, divide it into small Fields; say 5 or 6 Acres each. Let them be well cultivated with cleaning Crops, so as to destroy all the noxious Weeds or Grasses. The great Mistake of young Farmers. & the Disgrace of slovenly old ones, is to be in too great a Hurry in laying their grounds for grass. The Pests of bad precedent farming choak all their crops. Spare no Expence to destroy Weeds by cutting them before ripe, & frequent deep ploughing, with covering Crops. Weeds are the Jacobins of Agriculture. If you do not destroy them, they will certainly ruin you. French ploughing is the surest Way to get rid of them. If I can find a little Essay I wrote many Years ago on this Subject, I will send it to you. You make compost of all the Trash of your Farm, mixed with what little Dung you have & lime or Cystic shells. Have you any Pond or River Mud? This with ashes to give it stimulus is good for your Land.

I sow my Grass seeds at all seasons, as Circumstances require. On My Wheat Fields in February—with oats or Barley in the Spring also then with Flax— With Buckwheat in July— With Turnips in August. Timothy succeeds best in the Autumn. I cannot tell which is the best seed for your ground—if wet, Timothy or Hard Grass—if dry, red clover mixed with Timothy or orchard grass according to the situation. The latter absorbs the super abundant Juices of the Clover; & while growing preserves the crop from lodging or laying down. Salt your Clover while you are putting it into the Stack or Mow. A Bushell to 4 or 5 Tons. I would cheerfully send you Clover seed, but we have none better than your own. Sowing it thick or thin makes it fine or coarse. I generally sow 8 Pounds or Pints to the Acres & I find it fine enough. I have tried Lugeme, Onobrychis or Sainfoin, Burnet &c &c., but I stick to the red Clover because it sticks to me.... [17]

Hamilton sent for and received seeds, plantings, and advice from others in his locale and throughout the new nation — always, it seems, from staunch Federalists. One man who is supposed to have influenced Hamilton strongly in his ornamental plantings is Dr. David Hosack. Dr. Hosack was the Hamilton family physician, beginning in 1795. He was a professor of medicine at Columbia College and an eminent botanist, who was then in the process of establishing his Elgin Botanical Gardens on the site now occupied by Rockefeller Center.[18] (The ornamental plantings at Rockefeller Center are in commemoration of those gardens.) Dr. Hosack was a social as well as a professional friend of the Hamilton family, but aside from that, there is no clear evidence to indicate that Hamilton sought or took Hosack's advice for the Grange plantings more readily than he took the advice of a dozen others with whom he counseled concerning his plans for the development of his estate.

Two plantings in front of the Grange were Hamilton's own particular delights. One of these was a circular garden of ornamental flowers at the center of a circular drive terminating at the front entrance stoop. The other was a planting of commemorative trees in honor of the original 13 states.

Hamilton described his circular flower garden in front of the house:

...The space should be a circle of which the diameter is Eighteen feet: and there should be nine of each sort of flowers; but the gardener will do well to consult as to the season.

They may be arranged thus: Wild roses around the outside of the flower garden with laurel at foot.

...I should be glad if space could be prepared in the center of the flower garden for planting a few tulips, lilies, hyacinths, and [missing]. [19]

East of the main entrance to the house, Hamilton planted 13 trees representing the original members of the union of states. The trees were liquidambars, or gums.[20] No documented account of the planting or dedication of these trees has been found. However, the story that the trees were planted by or for Hamilton — and that his intention was to represent the new nation — has survived with sufficient vitality that the story stands until disproven, rather than vice versa. This is particularly so since such a group of trees did exist, and since the accounts of their origin circulated from a very early date and survive with only minor discrepancies. An anonymous account that appeared in the New York World in 1891 is representative of these accounts:

...At this house, in 1802, Hamilton gave a dinner that was largely attended by eminent statesmen. After the banquet they adjourned to the gardens surrounding the house. In the presence of his guests and to symbolize the thirteen original States of the Union, Hamilton planted thirteen sapling gum trees in a group, a few rods from the manor. The event was solemnized by prayer, speech-making, and all the festivities peculiar to the olden time.[21]

Aside from these two outstanding planting features, both of which survived until 1889, the original landscaping of the Grange is discernable only in a general way from the type of accounts presented above, and from views of the grounds as they appear in late 19th-century photographs, most of which are included here.

All of the accounts of life at the Grange have been written by family, fans, or friends, and so are somewhat less than objective. We are presented with a Federalist view of Hamilton the father and country squire. However, the accounts ring true. The estate reflected not only the personal and social needs of the family, but also the personality of Alexander Hamilton. "Retirement" to the Grange was no retirement at all. The house was a nerve and communications center for the personal, social, political, and professional life of a vital and thriving individual at a high plateau of accomplishment, with perhaps even greater heights in the offing.

If, in the great circle of activity that made up his life, the Grange was truly Alexander Hamilton's "hobby," then children were the "hobby" of Mrs. Hamilton. There were always many children at the Grange, the Hamilton children and others. Philip — the first born of Elizabeth and Alexander, and namesake of General Schuyler — died following a duel at Weehawken in November 1801, casting a cloud upon his family and the happy prospect of the new house in the country.[22] The loss was only slightly assuaged by the birth of the last Hamilton child, a boy, on June 2, 1802, a few weeks before the family moved into the new house.[23] This last child was named Philip, in remembrance of both the General and the first Philip.[24]

In addition to the two Hamilton daughters and five Hamilton sons, mention appears of many visiting youngsters. At one time, a cousin stayed weekends with the Hamiltons while attending a boarding school on Staten Island, along with one or two of the Hamilton youngsters.[25] A grandson of that school's master boarded with the Hamiltons.[26] Apparently, the children of some of Hamilton's French comrades-in-arms during the American Revolution were placed with him during the French Revolution. Fanny, the orphan child of a Colonel Autle who died in the American Revolution, was raised and educated as a member of the family, and is said to have married well.[27]

During the depths of winter, the house was difficult to heat. Thus, it was closed up, and the family moved back to town, where they occupied a house on Partition Street, now Fulton Street. [28]

Whether the family was ensconced in town or at the Grange, primary responsibility for its care and management fell to Mrs. Hamilton, because Hamilton was frequently away. A random sampling of letters from Hamilton to his wife in 1801 shows letters from Rhinebeck, New York; New Haven, Connecticut; Albany, New York; and Portsmouth, New Hampshire. Of first concern in this correspondence was the welfare of each other and of the children. Hamilton developed a sort of hypochondria — part of it a general illness resulting from exhaustion — so that he was comfortable nowhere except in the bosom of his family, whether in the city or at the Grange. In addition to the residence in the country, the exigencies of travel and commuting required that Hamilton maintain both an office and a residence in town. In 1801, his residence was listed at 107 Liberty; in 1802 and 1803, 58 Partition; and in 1804, at 12 Garden. [29] During 1802-1804, his quarterly house rent escalated from \$110 to \$118.75. [30]

When working at his office in lower Manhattan and the weather permitted, Hamilton commuted to the Grange. He drove to and from the city in a two-wheeled carriage with a single horse. [31] One of his horses was a bay named Peacock, which he had purchased from John C. Hammond of Trenton, New Jersey, in 1799 for \$120. [32] The trip usually took an hour and a half each way — slightly less from the Grange to town than in the other direction — and he usually made the circuit four or five times a week. [33] Stages also passed the Grange, and its proximity to the main stage routes was a point in favor of its location, although their schedules were still somewhat irregular. How often Hamilton used these vehicles to travel either up or down the Hudson Valley is little better than conjecture.

On some of these trips home to the Grange, Hamilton was accompanied by guests who had elected to partake of his hospitality. The Hamiltons long had been welcome company at Federalist dining tables in country and city. Gouverneur Morris, for example, mentions their dining with him in June and in August of 1801, and again in July 1802. [34] On July 14, 1802, the Hamiltons reciprocated: Morris noted in his diary that he was dining with "Genl Hamilton," and one assumes that this was at the Grange. [35] Rufus King drove over from Jamaica, Long Island, and others of equal note were regular and frequent visitors. [36] Only two of these social visits are satisfactorily documented — one, a visit by a distinguished jurist; the other, a visit by European royalty.

Chancellor James Kent described his sojourn in a letter to his wife, dated April 26, 1804:

...I went out with Gen. Hamilton on Saturday the 21st & Stayed til Sunday Evening. There was a furious and dreadful Storm on Saturday Night. It blew almost a Hurricane. His House Stands high & was very Much exposed...& I am certain that in the 2d Story where I Slept, It rocked like a cradle. He never appeared before So friendly & amiable. I was alone & he treated me with a minute attention that I did not suppose he knew how to bestowe. His Manners were also very delicate & chaste. His Daughter who is 19 Years old has a very uncommon Simplicity & Modesty of Deportment, & he appeared in his Domestic State the plain, modest & affectionate Father & Husband.... [37]

A more formal occasion involved the youngest brother of Napoleon — Jerome Bonaparte, who had been in America 10 months and married a Baltimore lady. He came to dine at the Grange in May 1804.[38] On May 7 (11?), Hamilton wrote from town to Mrs. Hamilton in the country:

My Dear Eliza

On Sunday Bonaparte & Wife with the Judges will dine with you. We shall be 16 in number if [Gouverneur] Morris will come. Send him the inclosed note on horseback, this Evening, that James[39] may bring me an answer in the morning. He is promised the little horse to return.

If not prevented by the cleaning of your house I hope the pleasure of seeing you tomorrow.

Let the waggon as well as the Coaches come in on Saturday. I mention this now, lest you should not come to town yourself. I have particular reasons for this request....[40]

Only in imagination can one join in the party in that lovely and affluent Manhattan suburb on that Saturday evening in 1804. The social success of the evening is beyond doubt. In 1837 or 1838, James A. Hamilton — who had carried the "note" in 1804 to Gouverneur Morris about plans for entertaining Bonaparte at the Grange — visited Bonaparte in Florence, Italy, while on a tour of Europe. He was entertained "midst much pomp and formality," in return for the hospitality enjoyed by Bonaparte at the Grange so many years earlier.[41]

A feature of both family and formal gatherings at the Grange was the piano playing and singing of daughter Angelica, accompanied by her father. Gouverneur Morris mentions a party at the Grange for some of the children, in June 1804:

...Go between two and three to Genl Hamilton's to a fete given to his Daughter's Acquaintances and return without being wet tho it constantly threatens....[42]

The most welcome and constant visitors of all were the members of the Schuyler family. The mutual affection between the members of the two households is evidenced by a mass of correspondence and external evidence.[43] Hamilton and his father-in-law enjoyed a familial and trusting relationship that bound them in devotion to the Federalist cause and to the success of their various enterprises, and which supported great warmth among all the members of their respective households. When the Grange was planned, General Schuyler selected the lumber, oversaw its proper aging, and gave it as a gift. When the Hamiltons were at the Grange, shipments of "prodigious gifts" arrived frequently by river sloop from the ample Schuyler ménages at Albany and Saratoga.[44]

There was no break in cordiality from the first introduction of Hamilton to the Schuyler family, and apparently never a harsh word among them. When the Grange mansion house was almost ready for occupancy, in August 1802, the General wrote to his daughter, Elizabeth Hamilton:

I am anxious to visit you and to participate in the pleasure of your country retreat which I am informed is fast reaching perfection. Embrace my dear Hamilton and the children. He and they participate with you in your mother's and my warmest affections. May health and happiness be the portion of all....[45]

Mary Gay Humphreys, in her biography of Catherine Schuyler, describes most aptly the internal condition and significance of the two households:

...No men were ever better entrenched for political conflict than Schuyler and Hamilton. Their homes were centres of peace; their material considerations guarded. Whatever strength they had was for the fray. Nothing could be more unlike the contest between Federalist and Democrat than the simple domestic record of these two households. The affectionate intercourse between children, parents, and grandparents reflected in all the correspondence accessible makes an effective contrast to the feverish state of public opinion and the controversies then raging. Nowhere would one find a more ideal illustration of the place home and family ties should supply as an alleviation for the turmoils and disappointments of public life. [46]

Particularly close was the relationship between the Hamiltons and Mrs. Hamilton's sister and brother-in-law, Angelica and John B. Church. (Church would be second in importance only to Gouverneur Morris in preserving Hamilton's estate for his widow and children.)

Hamilton received letters from time to time from both his brother, James, and from his father, usually when they were in need. He accepted drafts from them, and urged his father to come to New York to live with him and his family, but the response was negative. [47]

The full, rich life that Hamilton so much enjoyed depended economically upon two factors: his success in his profession, and his handling of his personal finances. His success at the bar is beyond question. If not the leader, he certainly was of the first rank. He was not only highly intelligent, but he also was able to organize his law firm in such a way that he did not have to preside personally over the day-to-day routine of his office. This arrangement — quite advanced for its time — permitted Hamilton to travel widely in his practice. [48] It also enabled him to delve into other projects in his many areas of interest. These projects ranged all the way from founding the New York Post to helping E.L. duPont select the site for his factory near Wilmington, Delaware. [49]

The handling of his personal finances was another matter. He kept relatively complete records, but basically, he overextended himself. This approach to financial management is characteristic of one rising toward extreme heights from the depths of financial obscurity. Hamilton was a gambler. He gambled on his ability, on his confidence in the future of the nation, and on the stability of the basic economic wealth of his generation, which was land. At the time of his death, he was essentially, land poor.

The best source of information about this would be his file of receipts — kept in his desk at the Grange — for every bill paid. This file would reveal every facet of Hamilton's financial existence, including the cost of building and maintaining the Grange, but it has not been located. It is not in the Hamilton papers in the Library of Congress, but neither has there been mention of its destruction or loss.

The documents that do exist — primarily Hamilton's correspondence and cash record account books in the Library of Congress — note expenditures for the Grange through to a few weeks before his death; they present a picture of a very costly "hobby." These are not specific enough to be attributed to anything other than routine work on the grounds. Two items that are socially illuminating relate the purchase of \$150 worth of wine.

These financial records, noted and filed at Federal Hall National Memorial, will relate to other material to be studied in detail concerning life at the Grange during this period. The state of Hamilton's personal finances will appear in the next chapter of this report, in the account of the management of the Hamilton estate.

The Grange was ever in Hamilton's thoughts. During one of his trips, he wrote to his wife on October 14, 1803:

...You see I do not forget the Grange. No, that I do not; nor any one that inhabits it. Accept yourself My tenderest affection. Give my love to your Children & remember me to Cornelia. [50]

But even dearer to him than the Grange was his wife, who had supervised its creation and gave it the spark of life. To her he had written with ardent candor throughout their life together. "Monday at furthest I embrace my angel....Think of me—dream of me and love me, my Betsy....Yours, my angel, with inviolable fidelity...." And in the last letter before Weehawken: "Adieu my darling, darling wife." [51]

NOTES

1. Martha J. Lamb, "Historic Homes and Landmarks: Their Significance and Present Condition," Magazine of American History, XXI, No. 1 (Jan. 1880), p. 6; S. Damie Stillman, "Artistry and Skill in the Architecture of John McComb, Jr.," p. 47.

2. H.W.C., "Kerelaw House: Historic Keeps and Castles and Stately Homes of Ayrshire...", Kilmarnock Standard, Apr. 5, 1924; Allan M. Hamilton, The Intimate Life of Alexander Hamilton, pp. 7-8, 13-16, 433 ff.; Lamb, "Historic Homes and Landmarks," p. 6, and "General Grant's Resting Place, Its Historic Associations," Magazine of American History, XIV, No. 3 (Sept. 1885), p. 236; Stillman, "John McComb, Jr.," p. 44; "Hamilton Grange," [title obliterated], Oct. 19, 1872, clipping in AS&HPS files.

3. To Herman LeRoy, a.l.s., BNY, transcribed by PAHPP.

4. NYCR, "Conveyances," Liber 218, pp. 226-229.

5. Ibid., pp. 227-228.

6. Ibid., pp. 229-232.

7. Ibid., p. 232.

8. Hamilton, Intimate Life, p. 355.

9. AH to EH, [May 10, 1801], AHP/LC, from PAHPP.

10. Ibid.

11. Ibid.

12. AH to EH, [Feb. 1801?], AHP/LC.

13. AH to EH, Oct. 16, [1801 or 1802], AHP/LC.

14. PAHPP, citing the D.A.B.

15. AH to Richard Peters, Dec. 29, 1802, PAHPP, from a.l.s., Harvard College Library.

16. Ibid. Compare with AH to Charles C. Pinckney, Dec. 29, 1802, PAHPP, from a.l.s., Charleston Library Society, Charleston, S.C.

17. Richard Peters to AH, Jan. 8, 1803, PAHPP, from AHP/LC.

18. David Hosack to John C. Hamilton, Jan. 1, 1833, AHP/LC; Kenneth Andrews, Dr. Hosack's Garden, pp. 5-6, 10, 16-17; Claire Klein, "Columbia and the Elgin Botanic Garden Property," Columbia Univ. Quarterly, Dec. 1939, pp. 272-274; Edward Preble, "David Hosack," D.A.B., IX, pp. 239-240; I.N. Phelps Stokes, The Iconography of Manhattan Island, V, pp. 1393, 1410, 1420, 1424, 1426, 1431; Raymond H. Torrey, "Hamilton Grange," S&HA, III, No. 3 (Apr. 1934), pp. 6-8.
19. Hamilton, Intimate Life, p. 348. A rough sketch by Hamilton of this circular planting scheme is reproduced on the page facing.
20. Robert B. Stover to the Rev. G. Ashton Oldham, Apr. 11, 1912, copy in AS&HPS files.
21. Name of newspapers and year only appear, from AS&HPS files. See also Josiah C. Pumpelly, "Alexander Hamilton and the Grange," Americana, Nov. 1912, p. 1010.
22. Nathan Schachner, Alexander Hamilton, p. 408; Richard B. Morris, ed., Alexander Hamilton and the Founding of the Nation, p. 601.
23. Torrey, "Hamilton Grange," p. 8. See also Allan M. Hamilton, Recollections of an Alienist, p. 16.
24. Pumpelly, "Alexander Hamilton," p. 1010.
25. Mary Gay Humphreys, Catherine Schuyler, p. 229.
26. AHCB, II, May 19, 1802.
27. James A. Hamilton, Reminiscences, p. 3.
28. Torrey, "Hamilton Grange," p. 10; "Hamilton, Gen. Alexander, 58 Partition," Longworth's American Almanac for [1802], microfilm, NYPL.
29. Longworth's American Almanac for the respective years, on microfilm, NYPL.
30. AHCB, II.
31. Hamilton, Reminiscences, p. 3.
32. Receipt, John C. Hammond to AH, AHP/LC (folio #93239).
33. Charles R. King, ed., Life and Correspondence of Rufus King, IV, p. 326.
34. Gouverneur Morris, ms diary, LC.
35. Ibid.
36. Pumpelly, "Alexander Hamilton," p. 1011.

37. Folios 377-380, the Papers of James Kent, III, 1799-1808, p. 378, Manuscript Div., LC. See also Broadus Mitchell, Alexander Hamilton: The National Adventure, 1788-1804, pp. 502-503; Hamilton, Intimate Life, p. 351.

38. Stokes, Iconography, V, pp. 1411-1412, 1414, 1421; VI, 51; King, Rufus King, IV, pp. 325-326.

39. Hamilton's son. James A. Hamilton would later recount memories of commuting to town with his father in his book, Reminiscences.

40. Hamilton, Reminiscences, p. 290.

41. Ibid., p. 3.

42. Morris, ms diaries, LC.

43. See particularly Hamilton, Intimate Life, p. 256.

44. Mitchell, The National Adventure, p. 502.

45. Aug. 22, 1802, quoted in Hamilton, Intimate Life, p. 340.

46. Humphreys, Catherine Schuyler, pp. 227-228.

47. Hamilton, Intimate Life, pp. 13-16; Hamilton, Reminiscences, pp. 2-3; AHCB, II, Nov. 29, 1796.

48. Hamilton, Reminiscences, pp. 5-6.

49. Howard Swiggett, The Extraordinary Mr. Morris, p. 354; Stokes, Iconography, V, p. 1387; E.I. duPont to Peter Bauduy, Dec. 27, 1801, Longwood Mss #7/IX/item 73, Eleutherian Mills Historical Collection.

50. PAHPP.

51. Swiggett, Morris, p. 144.

VI. THE ESTATE OF ALEXANDER HAMILTON

Alexander Hamilton was wounded by gunshot in a duel with Aaron Burr at Weehawken, New Jersey, on the morning of Wednesday, July 11, 1804. He died from the effects of that wound on the 12th in downtown Manhattan. Authors differ as to whether he left for the dueling ground from his home in lower Manhattan or from the Grange. Evidence favors the Grange. One piece of support for this theory is a statement repeated many times over the years by a son, John C. Hamilton, 13 years of age in July 1804:

The day before the duel I was sitting in a room [at the Grange] when at a slight noise I turned and saw my father in the doorway standing silently looking at me with a most sweet and beautiful expression of countenance, full of tenderness and without any of the business preoccupation he sometimes had. "John," said he, "won't you come and sleep with me to-night," and his voice was frank as if it had been my brother's instead of my father's. That night I went to his bed and in the morning very early he awakened me and taking my hands in his palms, all four hands extended, he told me to repeat the Lord's Prayer. Seventy years have since passed over my head, and I have forgotten many things, but not that tender expression when he stood looking at me at the door, nor the prayer we made together the morning just before the duel. [1]

A week earlier, on July 4, Hamilton had drafted -- and on July 10, wrote in final form -- a letter to his wife, in anticipation of a possibly fatal result from his meeting with Burr:

This letter, my very dear Eliza, will not be delivered to you unless I Shall first have terminated my earthly career, to begin, as I humbly hope from redeeming grace and divine mercy, a happy immortality.

If it had been possible for me to have avoided the interview, my love for you and my precious children would have been alone a decisive motive -- But it was not possible without Sacrifices which would have rendered me unworthy of your esteem.

I need not tell you of the pangs I feel, from the idea of quitting you and exposing you to the anguish which I know you would feel. Nor could I dwell on the topic lest it unman me.

The consolation of Religion, my beloved, can alone support you; and this you have a right to enjoy. Fly to the bosom of your God and be comforted. With my last idea I Shall cherish the wish [and] hope of meeting you in a better world.

Adieu best of wives and best of Women. Embrace all my Darling Children for me. [2]

During the days preceding the Burr duel, Hamilton made closing entries in his account book,[3] wrote several letters to be delivered only in the event of an outcome fatal to himself, and drafted a statement which stated his basic concepts concerning the obligation to duty of one in the public service:

...In the event which would bring this paper to the public eye, one thing at least would be put beyond doubt. This is that my public labors have amounted to an absolute sacrifice of the interests of my family, and that in all pecuniary concerns the delicacy no less than the probity of conduct in public stations has been such as to defy even the shadow of a question.

Indeed, I have not enjoyed the ordinary advantages incident to my military services. Being a member of Congress while the question of the commutation of the half pay of the army for a sum in gross was in debate, delicacy and a desire to be useful to the army by removing ideas of my having an interest in the question, induced me to write to the Secretary of War and relinquish my claim to half pay, which or the equivalent I have never received. Neither have I even applied for the lands allowed by the United States to officers of my rank.[4]

The benefits forborne by Hamilton in life, to avoid all reflections upon his devotion to duty, were awarded later to his widow with interest, by Acts of The Congress, as thoughtful memorials to the highest order of public servant.[5] These awards came to Mrs. Hamilton at times of particular financial need, when she required assistance in order to retain possession of the Grange and live adequately there.

A few days before the fatal duel, Hamilton was merely a well-known lawyer, the leader of a moribund party whose members by a large majority considered him a useless encumbrance, rather than an asset. The day following the duel he was transformed into a hero and apotheosized. There was some partisan purpose in the exalting, but there was also a sudden knowledge that a great man had passed away.[6] The reaction was as if he had been assassinated, rather than that he had fallen in a duel to which he had been a party. His body was interred in the cemetery in Trinity Churchyard, and, with great honor, at the expense of the Corporation of the City of New York.[7]

Hamilton's financial condition was excellent in its prospects while he was alive, but he could not have picked a less auspicious time to die.[8] Both his assets and his liabilities flowed from a policy of investment that he had followed for a quarter of a century.[9] Shortly after the close of the Revolutionary War, he had discussed with a number of his friends alternative courses of land investment. These men included Gouverneur Morris, John Jay, John Delafield, Robert Lenox, and Nicholas Low. Their considerations centered upon whether a course of investment would be more tenable in the wild lands of western New York or in the vicinity of New York City. Some men took one view, some the other. Hamilton invested in the wild lands, where several millions of acres were sold by the state of New York for prices as low as eight cents an acre.[10] The purchase of the Grange lands in upper Manhattan, being a personal investment, was an exception to this policy.

These "wild lands" constituted Hamilton's prime investment asset in 1804. At the time of his death, the mortgage obligations for these lands and his personal notes and mortgages for the Grange property and construction were the prime liabilities of his estate. [11]

Hamilton summed up the situation in a statement written during the days preceding the Burr duel:

My expenses while the first improvements of my country establishment were going on have been great, but they would this summer and fall reach the point at which it is my intention they should stop, at least till I should be better able than at present to add to them; and after a fair examination founded upon an actual account of my expenditures, I am persuaded that a plan I have contemplated for the next and succeeding years would bring my expenses of every kind within the compass of four thousand dollars yearly, exclusive of the interest of my country establishment. To this limit I have been resolved to reduce them, even though it should be necessary to lease that establishment for a few years. In the meantime, my lands now in a course of sale and settlement would accelerate the extinguishment of my debts, and in the end leave me a handsome clear property....

...my country establishment, though costly, promises by the progressive rise of property on this island [and] the felicity of its situation, to become more and more valuable. My chief apology is to those friends who have from mere kindness endorsed my paper discounted at the banks... [12]

Always the supreme realist, Hamilton drew a will — dated July 9 — which provided the legal framework for the salvation of an estate for his heirs presumptive. It was drawn simply but well, and did in fact achieve its intended purpose. The text of that will is Appendix C of this report. It provided for the following measures:

1. The appointment of John B. Church, Nicholas Fish, and Nathaniel Pendleton to be executors and trustees of the will.
2. The devise to these executors and trustees of all his real and personal property, in trust, as joint tenants.
3. The authorization of these executors and trustees, at their discretion, to dispose of the same as they might think fit, and to pay the proceeds, if any, after settlement of claims, to Mrs. Hamilton. [13]

Following the funeral and interment, the good wishes of Hamilton's friends were transformed into deeds. There was no dilemma, only some disagreement as to method. Even as he noted in his diary what thoughts to express in his oration at Hamilton's funeral, Gouverneur Morris began his recording of measures in this direction:

Friday 13 July 1804

...Mr. Hammond who dined with us desired me to think of some means to provide for poor Hamilton's family. Mr. Gracie and Mr. Woolcott [sic] called for the same Purpose. I had already mentioned the matter to Mr. Lord who seems to think a Subscription will not go down well because the Children have a rich Grandfather. Mr. Hamm[on] d mentions certain Engagements in Bank endorsed by Ludlow and David Ogden. The same thing probably exists as to him [and] Gracie and Woolcot [sic] — Be Motives what they may, I will use the Occasion and freely pay my quota. Clarkson will unquestionably do as much and David Ogden says he, Clarkson, will do more than he ought. He is a worthy fellow as indeed he always was, and is extremely wounded....[14]

This same group conferred again on the 15th, 16th, and 17th of July, 1804, on which date the form of a subscription notice was presented by Wolcott.[15] Morris recorded in his diary that

...My first idea was to collect about twenty of the most intimate friends whose Circumstances will permit them to do what their Hearts might prompt and that they should agree to pay his Debts which amount I am told to about twenty thousand Pounds. This however is objectionable on various Grounds. First the Paying of his Debts would according to his Will leave all his Estate at the Disposal of his Widow. This objection is alone sufficient.[16] But it is to be enquired in What Mode the Thing will be most acceptable to the family and in What Mode it will be least liable to Inspection by the World. To his family a Grant by Congress or the State Legislature would certainly be the most agreeable. Perhaps a Subscription rather extensive would as an Expression of public opinion and public gratitude be the least offensive. To exclude, as was desired by some, all who held political opinions different from his would be to make him the Member of a Party when he is no longer an Inhabitant of the Earth. Few if any of his political opponents will I believe give any thing but if they be so inclined I know not of any Right his particular friends have to refuse.... [17]

By the 18th of July, some of Hamilton's short-term creditors had approached one of the Executors about payment.[18] Morris thereupon

...suggest[ed] that the Executor[s] should execute a Deed under the Power contained in the Will and that the Chancellor order the Children to execute as they come of Age—This is agreed to.... [19]

The details of these proposals were developed and refined during the course of the remainder of the summer. Oliver Wolcott wrote to Rufus King on August 14 that "...Every vestige of our friend's earnings will vanish unless the proposed contribution is successful." [20] In order to provide room for the necessary details of the

"subscription" to be organized and executed, the Grange house and lands were secured for the indemnity of short-term creditors in an amount approximating \$20,000, including claims against the property itself.[21] The major reason for adopting this course of action was stated by Wolcott in his August 14 letter to King:

...Mrs. Hamilton's attachment to this country seat you well know. The necessity of selling it would excessively distress her....[22]

Gouverneur Morris wrote to Robert Morris:

Our friend Hamilton has been suddenly cut off in the midst of embarrassments which would have required years of professional industry to set straight: a debt of between fifty and sixty thousand dollars hanging over him, a property which in time may sell for seventy thousand or eighty thousand, but which, if brought to the hammer, would not, in all probability, fetch forty; a family of seven young children. We have opened a subscription to provide for these orphans, and his warm-hearted friends, judging of others by themselves, expect more from it than I do.[23]

All objections were met, and a consortium was organized.[24] Names of 105 trustees and members of that consortium that have been identified are listed in Appendix D of this report.[25] Four hundred and two shares were subscribed and paid for at \$200 for each share, a total of \$80,400.[26] The shares were so drafted that no subscriber could do any better than receive back \$200 per share. Any profits or dividends would revert to the trustees for disposition.[27] At the end of July 1804, \$40,200 of the amount was already on deposit in the Bank of New York.

Next, the executors of the will recorded a conveyance to themselves on January 7, 1805, of all the personal and real property of the deceased, subject to the mortgage obligations to Schieffelin and Bradhurst and all other creditors.[29] On January 26, 1805, the trustees of Hamilton's estate contracted to sell to the trustees of the consortium all of Hamilton's speculative landholdings for the sum of \$39,700, effective April 5, 1805.[30] In this manner, immediate cash requirements of the consortium were met and legal protests of the decedent's notes forestalled. The contract was executed on April 5; the consortium thus fulfilled its preliminary mission of keeping the estate solvent, so as to prevent a forced sale of assets.[31]

The Grange estate was sold by order of the executors of the will on April 8, 1805, at public auction conducted at the Tontine Coffee House.[32] It was knocked down for the sum of \$30,000 to Archibald Gracie, representing the consortium.[33] This forced-sale price was subject to the mortgage of Schieffelin, in the amount of \$4,000, and the mortgage of Bradhurst, in the amount of \$3,648.56 (\$3,355 principal, \$293.56 interest).[34] Taking into account this activity in the market place, the fair market value of the Grange lands and buildings at that time totaled \$37,648.56.

The debt to Bradhurst, secured by a mortgage on the second and third parcels of the Grange property, was incurred when a person defaulted on a note that Hamilton had endorsed as an accommodation.[35] The incident had precipitated a crisis in his

financial affairs.[36] That note and interest was now satisfied, and the mortgage obligation removed by agreement between Samuel Bradhurst and John B. Church, trustee of the estate.[37]

Conveyance of the Grange was made to Mrs. Hamilton by an indenture dated July 6, 1805, that was not recorded until 1827.[38] An indenture formalizing the existence of the consortium was recorded January 11, 1806.[39] This quite detailed and illuminating document states that the assets of the estate amounted to \$74,150, and the liabilities to \$54,722.[40] The reason given for formation of the consortium is that "...from the loss generally experienced when forced Sales of real Estate have been made, there is great reason to believe that the property mentioned in the said Statement would under such circumstances be insufficient to discharge the said debts." [41] Finally, the "wild lands" were mapped, platted, and sold at a series of auctions.[42] By 1808, the crisis was over. Hamilton's heirs secured the Grange free and clear, as well as a sum of money approximating \$20,000.[43]

Such is the sequence revealed by the documents of the Hamilton estate. These facts were kept a secret from all but those directly involved. Mrs. Hamilton knew, but none of the children did. When James A. Hamilton — who was 16 years old when his father died — first heard of the matter in 1824 and made inquiry, he received a most gracious reply. It described the operation in reasonably accurate detail — except for the white lie that it was a speculation that might have ended profitably for all who joined.[44]

Other aid also came to Hamilton's widow in consequence of her late husband's public service. As his heir, she received a warrant for 450 acres of bounty land due for his service in the Revolutionary War; [45] in 1816, she received \$10,609.64, as a bonus for his military service, which included \$7,009.64 of interest.[46] Mrs. Hamilton pursued her life with undiminished vigor. Her activities and interests expanded as the members of her family grew to adulthood and set out to form their own households and careers. She continued to own the Grange, and to occupy it at least part of each year. Son James wrote later of her in his Reminiscences:

...It was my good fortune to have almost the entire care and management of her affairs. The elder son, Alexander, was away from home attending to his commercial affairs. I remained at the Grange with her as long as she remained there, attending to the cultivation and household, and after her father's death I became useful in collecting her rents and selling such parts of her property as her needs required....She was a most earnest, energetic, and intelligent woman. Her engagements as a principal of the widow's Society and Orphan Asylum were incessant. In support of these institutions she was constantly employed and as I once playfully told her, "Mama, you are a sturdy beggar." She replied, "My dear son, I cannot spare myself or others; my Maker has pointed out this duty to me, and has given me the ability and inclination to perform it." Her mind and body never rested, because both were always employed. She was a skillful house-wife; expert at making sweet-meats and pastry; she made the undergarments for her children, was a great economist and most excellent manager.... [47]

There are letters written by Mrs. Hamilton at the Grange as late as 1819, and many published notes and mentions of her good works and interests in the Harlem section. [48] There has been conjecture that Mrs. Hamilton rented out the Grange at one time or another. There is no documentation for this. To her, the Grange and the children were reliquaries of her beloved husband, and sacred to her. Precisely when she ceased to spend part of her time at the Grange is not clear. A letter to son James, written in 1827, might have been sent from the Grange, though it carries no identification:

My Dear Son: Your unremitting kindness and attentions, and in this last instance of providing for my comfort, demands my most ardent and affectionate thanks. As I think my wants will not require your enclosed check until the autumn, let me say to you that when I shall require your goodness to aid me I will call upon you. As all good acts are recorded in the habitation where your father now is, I have not doubt this one will be proclaimed to him, and have thus given him another motive to implore continued blessings upon you. Amen, my dear son! [49]

In 1827, all of the major transactions by which the Grange property had been assembled and preserved were recorded. These were:

1. Purchase of the original parcel by Hamilton from Schieffelin on August 2, 1800, recorded April 3, 1827. [50]
2. Conveyance of the first Bradhurst parcel, conveyed by Bradhurst to Hamilton on September 27, 1800, recorded April 5, 1827. [51]
3. Conveyance of the second Bradhurst parcel and release of the mortgage obligations on both the Bradhurst parcels, the second Bradhurst parcel having been conveyed by Bradhurst to Hamilton on January 10, 1803, and the mortgage obligation having been satisfied by the trustees of his will on April 11, 1805, recorded April 5, 1827. [52]
4. Conveyance of the Grange by the executors of Hamilton's will to Mrs. Hamilton on July 6, 1805, recorded April 5, 1827. [53]

Elizabeth Hamilton sold the Grange in 1833. Consideration was \$25,000, subject to a mortgage of \$9,500. The area was listed as 32 acres, 3 roods, and 20 perches. The transaction was recorded March 15, 1834. [54]

Mrs. Hamilton's remaining years were spent in Washington, D.C. [55] A neighbor's child later wrote of her at this time:

When I was a child of twelve or thirteen, I spent the winter in Washington, and had the good fortune to know Mrs. Alexander Hamilton, whom I remember to this day with vivid interest and love. It was probably pleasant for her to have a young person about her, and for days and often weeks at a time she and her widowed daughter would have me with them....

Mrs. Hamilton's favorite room in her house, which was on H Street, near the site of the Presbyterian church, was the front room of the English basement, the dining-room being back of it. There, by the window, in her own particular chair, she sat for hours, either looking out, or weaving mats on a small frame with pins along the sides. No longer able to read or even to knit, this work was a great resource to her who had always been full of activity. Precluded from any social exertion by her great age (she was then ninety-five), she often seemed pleased to turn to me for amusement. I would read to her, or sit near and sew my bits of work while she was in a talkative mood; or, in fine weather, I would walk with her. Leaning her right hand on a stout cane, and her left arm upon my arm, she would walk several blocks, generally to a florist's, for she was passionately fond of flowers; and always there was from her a cheerful little stream of talk, either of reminiscences, or of observations of nature, or of philosophical reverie, when everything else seemed to be forgotten....

After dinner, it was the custom for Mrs. Hamilton, if well enough, to spend an hour or so in the large parlors on the first floor, where every evening there were many visitors, friends and strangers. Generally she enjoyed their calls, taking part in the conversation and showing a lively interest in current affairs; but sometimes she was unable to make the exertion. She did not make calls herself, but once I remember she went to one of President Pierce's receptions. When it was known that the widow of Alexander Hamilton was present, she became the attraction of the evening; and the President, anxious to do her honor, left his place, offered his arm, and escorted her around the East Room.

Her dress, always black, of wool in the morning and of silk or satin in the evening, had been made after the same fashion for many years. She wore a plain, rather short waist folded over (not under) a muslin kerchief. Around her neck was a broad, finely plaited ruffle fastened behind, and a small soft shawl was laid over her shoulders. Her face, with its fine features, was framed by a plain snowy cap edged with a finely plaited ruffle, and tied under the chin. Some of the fire of youth still shone in those dark eyes, as she sat and talked with her guests, or, when they had gone, she slowly walked about the large rooms, leaning on her cane, pausing at one old bit or another of furniture to tell me its history. These rooms were crowded with relics, -- swords, books, china, pictures, and many other things whose history I would gladly recall. The side wall near the entrance door was almost covered with a large half-length portrait of Washington, who sat to Stuart for it, and gave it to Hamilton. Under a large handsome centre table in the front parlor was a great silver wine-cooler, also a gift from Washington. I remember nothing more distinctly than a sofa and chairs with spindle legs, upholstered in black broadcloth,

embroidered in flowery wreaths by Mrs. Hamilton herself, and a marble bust of Hamilton standing on its pedestal in draped corner. That bust I can never forget, for the old lady always paused before it in her tour of the rooms, and, leaning on her cane, gazed and gazed, as if she could never be satisfied.

She always called him Hamilton. One night, I remember, she seemed sad and absent-minded, and could not go to the parlor where there were visitors, but sat near the fire and played backgammon for a while; when the game was done, she leaned back in her chair a long time with closed eyes, as if lost to all around her. I never heard her complain, and I loved her with a reverent love that made me feel awed as the long silence was broken by the murmured words, "I am so tired,—it is so long. I want to see Hamilton." What thoughts must have come to her from the past!—for she had griefs and losses beyond the usual grievous lot of woman.... [56]

Mrs. Hamilton, born Elizabeth Schuyler, August 9, 1757, died in Washington, D.C., in the arms of her son, James, on November 8, 1854. [57]

Moses Henriques, to whom Mrs. Hamilton had sold the Grange, was an agent representing a client of his Wall Street banking firm, and the property was conveyed immediately to one Theodore E. Davis, a real estate investor and speculator. [58] Davis sold the property in 1835 to Isaac G. Pearson, for \$52,511. [59] The Grange vicinity became increasingly — though yet lightly — populated during these years.

In 1835, Pearson gave a mortgage in the amount of \$15,000 to Samuel Ward, with the Grange as security. He was declared bankrupt in 1842, and in 1845, the Grange became Ward's property. [60] Through some personal arrangement, the property actually was occupied and possessed by Samuel Ward's brother, William G. Ward, and his family. [61] William, a member of the Wall Street banking firm of Prime, Ward, and Company, died in July 1848. His widow and four sons, and the latter's families, continued to use the Grange as a summer home until 1876. Life at the Grange during this period probably can be well documented by means of a search through the extensive papers of the Ward family in the Connecticut Historical Society and the New-York Historical Society. A number of biographies have been published about members of the family of that period, most notably about the fabled Samuel Ward.

The continued increase in the density of habitation of this area is documented in Illustration 32. The year depicted is actually 1850, although the map itself bears the publication date of 1851. In 1854, James C. Carter described the Grange as follows:

The house is nearly square, of moderate size and well proportioned. The front is on the southern side; it is two stories in height, exclusive of the basement, and would have been at the time it was built a handsome and expensive one. The basement is used for culinary purposes, and the first story, which contains the parlors, is reached by a short flight of steps. You enter a commodious hall of a pentagonal form. On either side is a small apartment, of which the one on the right was the study, and contained the library of Hamilton. At the

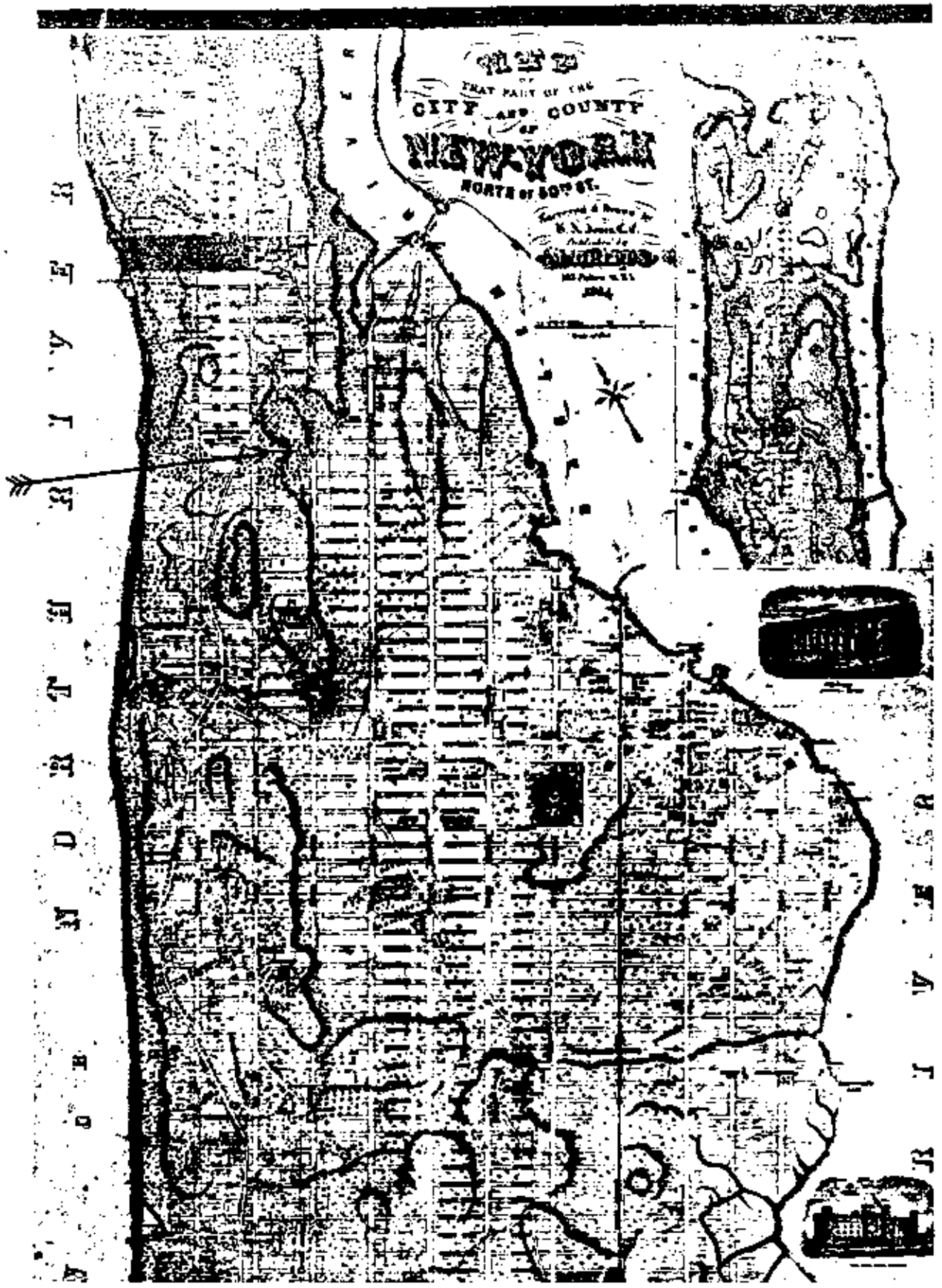

Illustration 32. The Grange Vicinity (1850).

end of the hall are doors, one on the right and the other one on the left, which open into the parlors. These are of moderate size and connected by doors, opening which they are thrown into one large room. The one on the right as you enter the house is now, and probably was when Hamilton occupied it, used as a dining-room. The other parlor is furnished for the drawing-room. It is an octagon in form, of which three sides are occupied by doors, leading to the hall in front, the dining-room, and to a hall in the rear. In two of the opposite sides are windows reaching to the floor, and opening upon the lawn on the easterly side of the house. The three doors before mentioned are faced with mirrors, and being directly opposite the windows, they throw back the delightful landscape which appears through the latter with a pleasing effect. The story above is commodious, and divided into the usual apartments. On the north the prospect is interrupted by higher ground, and on the south by trees. On the west a view is caught of the beautiful shore of New Jersey, on the opposite side of the Hudson. From the eastern side, and especially from the balcony which extends in front of the windows of the drawing-room [sic], a magnificent prospect is presented. The elevation being some 200 feet above the surrounding waters, a complete view of the lower lands and of the country in the distance is commanded. Harlem, with its river, the East River and Long Island Sound now dotted with a thousand sails, the fertile county of Westchester, and Long Island stretching away to the horizon, with its lovely and diversified scenery, are all in full view. [62]

Illustration 33 is the earliest known photograph of the Grange, showing several of Hamilton's gum trees at far right. It is dated c. 1864. Illustrations 34 and 35 have relatively certain dates: they were taken during the residency of the Ward family, which ended in 1876. In this year, the heirs of William C. Ward lost the property by foreclosure to the Emigrant Industrial Savings Bank of New York, owing \$53,402. [63] The bank sold the property in 1879 to agent Anthony Mowbray for \$312,500, who conveyed it for the same sum to his principal, William H. DeForest, on October 10, 1879. [64] A view of the property during this general period is Illustration 36, which is a photograph given to Dr. Herbert R. Moody by two grandnephews of Alexander Hamilton.

DeForest, with his son -- William H., Jr. -- was an importer and silk merchant who more and more was turning his business interests toward real estate investment. [65] DeForest purchased the Grange property to divide it into building lots. [66] George A. Townsend, the Civil War reporter who used the pen name "GATH," described the Grange after seven years of DeForest ownership:

Few persons have had the privilege to enter Alexander Hamilton's country house, which lies between Tenth avenue and the Morningside Park in the rear of the Convent of the Sacred Heart. [67] Chance took me there last Sunday, a gentleman in the vicinity giving me a line to Mr. Allen, a contractor, who inhabits the house. The Grange, as the tract is called, comprises down to the present time 300 building lots,

which the owner, Mr. DeForest, a downtown merchant, offers for sale at \$5,000 per lot, making the property aggregate the remarkable valuation of \$1,500,000.

It must not be supposed, however, that Alexander Hamilton ever was a wealthy man; on the contrary, his country seat was above the nature of his income....

The House Described.

Lest I lack an initial point in my sketch let me rapidly describe the old house as it stands. The Third Avenue Cable Railroad extension now runs right before General Hamilton's gate; the fence along the highway and crumbling stone walls are indicative of the lapse of time; there is no gate, strictly speaking, open, but a kind of awkward wicket through which you have to pass into a grassy lawn and woods. To the right rise the chestnut, oak and gum trees, a few of them very large and all indicative of a century's growth; to the left is a tumble-down paling fence and a small frame tenement behind it, suggestive of a former garden. The old grange is seen two or three hundred yards from the gate, rising upon a stoney and rocky swell of the field. For want of paint it looks much older than it might be made to appear; it is of a dingy yellow color, and all that is seen of it externally is frame built, but, in fact, within the frame is all filled with brick, so as to keep the house dry and hold it up straight.

On the east and west sides of the house are piazzas of uniform length with balusters above them, each piazza perhaps thirty feet long by eight feet wide. The entrances to the house, which occupy the other two sides north and south are porches, probably twelve feet square, and surmounted with balusters like the two piazzas; and so the entire house is balustered at the square top all around. The house stands nearly square and is perhaps forty to forty-five feet long and wide.

...

The Grange Now.

...Ascending the steps and knocking upon the door, the bell having disappeared, I was courteously admitted to the old homestead, and in a few minutes the occupant came in and kindly showed me enough of the house to settle its form and advantages in my mind.

...Going in at the south door one stands in a small hall or vestibule, and right before him is an arch, under which are set in angles two doors, leading on the right to the dining room. Out of this somewhat short hall a nearer door to the right enters Hamilton's little library, which is square, and probably 20 x 16 feet in the size....



THE GRANGE ABOUT 1864

Illustration 33. The Grange: South Elevation (c. 1864).



Illustration 34. The Grange: South and West Elevations (before 1876).



Illustration 35. The Grange: North and West Elevations (before 1876).



Illustration 36. The Grange: North and East Elevations (before 1888).



Illustration 37. The Grange: Replacement Mantel, First-Floor Northeast Room (1955).



Illustration 38. The Grange: South and East Elevations, with Grove of Gum Trees (c. 1884-1888).



Illustration 39. The Grange: South and West Elevations (c. 1888).

On the other side of the vestibule, oddly hidden in the shell thereof, is the stairway which climbs to the upper floors....

I entered the general's little drawing room, which extends across one half the house, and is perhaps twenty-five feet long, with a window looking out toward the Hudson. In this room was a very excellent wooden mantel which the proprietor sometime ago removed and set up in his city mansion, substituting for it a modern stone or marble mantel. This portion of the house has been repapered without losing its form, and one can, with a little effort, imagine Hamilton's wife and children here and himself playing the piano for their gratification....

Hamilton's Tableside.

Passing now into the dining-room, also octagonal, but with the ends shorter than the sides, one sees the methods by which the food was brought in from the servants quarters....

When Hamilton lived in the house these octagonal rooms were decorated with mirrors,...Mr. Allen says that the basement of the Grange is the most interesting portion of the house at the present day.

The Best Relic Left in New York

This house...enshrines that time of his life when he was in his golden flower....[68]

It was during the years 1879-1886 that certainly two and possibly three of the four mantels now missing from the Grange were removed. These were the mantels in the two octagon rooms, and the mantel in the first-floor northeast room. Mantels installed as replacements are shown in Illustrations 21 and 37. The DeForest town house to which they were removed was at 12 West 57th Street -- now a parking lot on the 56th-Street side of the Henri Bendel store at 10 West 57th Street. This structure was razed only two years ago, to make way for a parking lot.[69] Such mantels were in the structure as recently as 1935, and perhaps can be located.

The mirrors in the octagon rooms were removed during this same period, and also may have been installed in the town house or houses of the DeForest family.[70] The missing mantel in the first-floor northwest room, judging by extant moldings in that room, was not ornate, and probably was not taken by the DeForests. It most likely was lost when the fireplace was closed up, perhaps in 1914 when the room was converted to a kitchen.

Additional exterior views of the Grange during the 1880's are Illustrations 38 and 39; the former shows the grove of gum trees at right.

NOTES

1. Josiah H. Pumpelly, "Alexander Hamilton and the Grange," Americana, Nov. 1912, p. 1014.
2. Draft is folio #93355, AHP/LC (Second Series, 1917).
3. Ms, AHCB, II.
4. Alexander Hamilton, Works, X, p.479.
5. AHP/LC.
6. Nathan Schachner, Alexander Hamilton, p. 430 .
7. AH death certificate, copy in AHP/BNY.
8. James A. Hamilton, Reminiscences, p. 4.
9. Ibid., p. 8.
10. Ibid.
11. Ibid.
12. Allan M. Hamilton, The Intimate Life of Alexander Hamilton, pp. 419-420.
13. AHP/LC; Hamilton, Intimate Life, pp. 413-414.
14. Morris, ms diary, LC.
15. Ibid.
16. At this time, Gouverneur Morris was still a bachelor.
17. Morris, ms diary, LC.
18. Ibid.
19. Ibid.
20. Charles R. King, ed., Life and Correspondence of Rufus King, IV, p. 577.
21. Ibid.
22. Ibid.
23. Ibid., p. 403.

24. William Popham to James A. Hamilton, Oct. 14, 1824, Morris-Popham Papers, LC (II-42-D, p. 3).
25. See Josephine Mayer and Robert A. East, "The Settlement of Alexander Hamilton's Debts: A Footnote to History," New York History, XVIII, No. 4 (Oct. 1937), pp. 378-385.
26. Undated contemporary audit, AHP/BNY.
27. See various of the certificates in AHP/LC or AHP/BNY.
28. Statement of account, AHP/BNY.
29. NYCR, "Conveyances," Liber 71, pp. 347-349.
30. Document of agreement, AHP/BNY. See also King, Rufus King, IV, pp. 408-409.
31. The draft to the order of the trustees of the estate, signed by all the trustees of the consortium, remains in AHP/BNY.
32. I.N. Phelps Stokes, The Iconography of Manhattan Island, III, p. 774, V, p. 1434.
33. Copy of statement signed by Archibald Gracie and undated contemporary audit, AHP/BNY.
34. Receipt, Samuel Bradhurst to estate of Alexander Hamilton, AHP/LC.
35. AH to Oliver Wolcott, [Sept.] 1803, AHP/LC.
36. Ibid.
37. NYCR, "Conveyances," Liber 218, pp. 229-232.
38. Ibid., pp. 232-234.
39. Ibid., Liber 71, pp. 375-380.
40. Ibid., p. 377.
41. Ibid.
42. AHP/BNY; folio #93371-93371a, 1917, AHP/LC.
43. Rufus King to C. Gore, Jan. 10, 1808, in King, Rufus King, IV, pp. 409-410.
44. James A. Hamilton to William Popham, Oct. 14, 1824, Popham to Hamilton, unsigned draft, Oct. 14, 1824, Morris-Popham Papers, LC (II-42-D, p. 3 and III-42-D, p. 3); Hamilton, Reminiscences, p. 9.

45. AHP/LC.
46. "An Act for the relief of Elizabeth Hamilton," approved Apr. 29, 1816, AHP/LC (folio #93374, Second Series, 1917).
47. Hamilton, Reminiscences, p. 47.
48. EH to her sister, Oct. 26, 1819, AHP/LC; Stokes, Iconography, V, p. 1603.
49. May 11, 1827, quoted in Hamilton, Reminiscences, p. 64.
50. NYCR, "Conveyances," Liber 218, pp. 223-226.
51. Ibid., pp. 226-229.
52. Ibid., pp. 229-232.
53. Ibid., pp. 232-234.
54. Ibid., Liber 309, pp. 469-470.
55. Hamilton, Reminiscences, p. 64.
56. "Reminiscences of Mrs. Alexander Hamilton," Atlantic Monthly, LXXVII, No. CCCCLXVI (Aug. 1896), pp. 282-284.
57. Mary Gay Humphreys, Catherine Schuyler, p. 52; Hamilton, Reminiscences, p. 64.
58. NYCR, "Conveyances," Liber 309, pp. 471-473; John H. Morrison, ms, "Chain of Title," for AS&HPS; Raymond H. Torrey, "Hamilton Grange," S&HA, III, No. 3 (Apr. 1934), p. 16.
59. NYCR, "Conveyances," Liber 329, pp. 531-533; Morrison, "Chain of Title"; Torrey, "Hamilton Grange," p. 16.
60. NYCR, "Conveyances," Liber 464, pp. 215-220.
61. Morrison, "Chain of Title."
62. James C. Carter, "Hamilton," Homes of American Statesmen, reprint in AS&HPS files.
63. Morrison, "Chain of Title."
64. NYCR, "Conveyances," Liber 1505, p. 494; Liber 1517, p. 17; Morrison, "Chain of Title."
65. See listings for both of these men in Trow's New York City Directory for 1885-1891. In the latter year, the son opened an office at 111 Broadway, apparently from then on dealing primarily in real estate.

66. Mrs. H. Croswell Tuttle, History of Saint Luke's Church in the City of New York 1820-1920, p. 563.

67. Now the campus of the University of the City of New York.

68. George A. Townsend, "Ghosts of the Grange," (publication source unidentified), c. Oct. 10, 1886, in MCNY clipping file.

69. Conversation with Henry Bendel, Jr.

70. Pumpelly, "Alexander Hamilton," pp. 1018-1019.

VII. RELOCATION OF THE GRANGE

In 1807, commissioners were appointed who laid out the Manhattan street system on a rectangular plan. The movement of population northward up Manhattan made inevitable the arrival of a day when this pattern would threaten the randomly situated Grange. It came in the 1880's, when Harlem was the scene of a building boom.[1] As the streets numbered in the 140's were laid out, 143d Street ran through the northwest corner of the Grange, which lay askew of the surveyed lot lines.[2] Consequently, on its original site the Grange was doomed — an obstacle to progress and to the manifest destiny of urbanization.

At the same time that Harlem was being urbanized, the northward migration caused one of the downtown churches to think of relocating, too. St. Luke's Episcopal Church, on the west side of Hudson Street opposite Grove Street in lower Manhattan, was seeking a new site "uptown" in the Grange area.[3] The rector of St. Luke's, the Rev. Isaac Henry Tuttle, was one of a committee searching for an appropriate site. Observing the large, old-fashioned, frame dwelling as he perused the Grange neighborhood, he made contact with DeForest and with Amos Cotting, a wealthy Wall Street broker who recently had invested in the lots south of 143d Street, on which the Grange sat.[4] Cotting, learning of the plans and intentions of the church body, sensed that a gift here would be a wise investment. He offered to donate the Grange, and to move it to another site that he would donate as well, provided that the Grange be utilized as a chapel until a new St. Luke's Church edifice could be constructed on the corner lot adjoining the Grange relocation site.[5] Soon afterward, the Rev. Tuttle learned the "old-fashioned frame dwelling" was the Grange of Alexander Hamilton.[6]

The vestry of the church accepted the offer, sight unseen, at a meeting on October 22, 1888. At the same meeting, decisions were made to visit the site on October 29, and to purchase for \$50,000 the five lots on the northeast corner of Convent Avenue at 141st Street adjoining the Grange relocation site.[7] Thus, the church would have the six lots bounded on the east by Hamilton Place, on the south by 141st Street, and on the west by Convent Avenue — the one lot donated with the Grange structure and the other five purchased by the church vestry. The acceptance of Cotting's offer and thanks tendered by the vestry are noted briefly in the vestry minutes of January 24, 1889.[8] Further credit in the amount of \$10,000 was donated to the church by the lot owners, so the net cost was reduced to \$40,000.[9]

Because a large number of its parishoners had already moved into the area by this time, St. Luke's Church began using the Grange even before it was moved and formally conveyed to the congregation. However, planning for the relocation continued apace. To obtain the necessary permit to transport the Grange the 300 feet to its new site, and for its renovation, an application was filed with the Department of Buildings of the City of New York on November 12, 1888. It was approved by the Superintendent of Buildings on December 3. The application, the permit, and several documents filed as part of the application are filed in the folder for Lot #1, Block 2050, at the Plans Desk of the Department of Buildings, Borough of Manhattan, New York City. The filing is erroneous, but the material does exist and was located in the folder noted.

These documents reveal much about the structure on its original site, as well as its projected move and renovation. The size of the lot on which the Grange sat in 1888 is shown as being of irregular shape, 125 by 200 by 100 feet. The structure is listed as measuring 36.9 feet across its front and rear, and as being 46.7 feet in depth.

Its number of stories is listed as two, and the number of feet in height, from curb level to highest point of beams, as 25. Depth of the foundation walls was 10 feet; thickness of foundation walls, 20 inches; and materials of foundation walls, stone and brick. The roof is listed as being flat, which must be an error, because earlier photographs show it as being ridge-hipped.

The "definite particulars" required by the permit application are given as:

Present building now standing SW cor 143d st and Convent Av.
to be moved to N.E. cor 141st St. & Convent & set on stone
foundation 20 in. thick 10 ft high laid in cement mortar. Base
Stones 2 x 3 ft Reasons for moving. To make improvements
on present Site

A more detailed statement of purpose was required, however. This was filed December 3, 1888, and the entire application was approved the next day. The revised statement reads:

It is proposed to preserve, and remove the Mansion herein described, to new site shown on accompanying Map. All of the property owners in the Grange approving of the Scheme. (See attached Statement) In addition it is proposed to Move the front Stoop and Steps to West Side, 2 Windows and door to be closed up in Basement, and 2 New Doors opened. Also New Area Steps- The present building Now Standing on N.W. Corner of Convent Ave. and 143d Street to be moved to N.E. Corner Convent Ave and 141st Street, and Set on a Stone foundation 20" thick x 10 feet high, Base Stones 2 ft x 3 ft x 8" Reasons for Moving to make room for improvements on present site. Central Partitions and Staircase to be Moved, in inside— (See Drawings) The Mansion will be used as Parsonage for St. Paul's [sic] New Stone Church, to [be] erected Near it.

/signed:/ J D Butler

per T H Dunn

Approved

/signed:/ T J Brady

Dec 4th 1888 Depty Supt of Bdg

The "accompanying map" referred to is Illustration 40, which shows the relationship between the "old site" on 143rd Street, west of Convent Avenue, and the proposed "new site," east of Convent Avenue and north of 141st Street. The "attached Statement" of the adjoining landowners reads as follows:

This is to certify that we the undersigned, owners of the adjoining property, and about 50 Buildings, and many plots of Land, in Hamilton Grange, do approve of the preservation, and removal, of the Hamilton Mansion to the proposed Site, as located in the accompanying application-and believe the balance of the property owners are in accord with us, as their

interests are identical with ours, as far as concerns the removal of the Mansion, &c.

/signed:/ W.H. De Forest-
/ " / J.D. Butler
/ " / W.H. DeForest Jr

Witness

Thos. H Dunn
Archit

The "Drawings" mentioned in parentheses are Illustrations 41 and 42, which representationally depict the contemplated alterations. On the original diagrams, red color was used to "indicate old parts which [in the plan] have been changed or altered." The most significant information provided here is the layout of the original basement, and the general contour of the main stair prior to its radical rebuilding. However, the plans include a few errors. It is highly unlikely that the original basement stair would have led up into the front entrance hall. The "original" main stair shows four runs of steps, rather than the actual three. The attic stair is not shown at all, either in its original or changed location. And the intended partition in the first-floor rear hall apparently was never constructed.

Information in the Buildings Department folder indicates that the moving of the house began on December 5, 1888, and that the renovations after the relocation — also authorized by the December permit — were completed and approved on June 29, 1889. The structure is shown in Illustration 43 after it had been raised up off of its original foundation and prepared for its move to the relocation site. The old basement walls have been demolished, to allow the lifting equipment to get underneath the house. And the front portico has been removed; the scar where it was attached stands out clearly. A contemporary journalist, observing the work under way, commented that "...The workmanship of the house is solid and substantial, befitting the character of its illustrious occupant....The old edifice is now, at this writing, itself on wheels, having started on a journey toward a new site, for the specific accommodation of a New York street...."[10] A sentimental neighbor took cuttings from ivy at the site for replanting at a summer home at Spring Lake, New Jersey.[11]

The Grange next appears in Illustration 44 after it had been moved to its new site, 100 yards southeast from its old one. It was lowered onto a prepared foundation conforming to the new street pattern and lot lines. Unfortunately, the new site was too narrow to allow the Grange to be positioned and restored as it was originally. The main, south entranceway thus was closed up, and the components of this feature moved intact to the south end of the west wall (Ills. 45, 46). The south entry portico was moved to the center of the west piazza (Ill. 47); the square, c.-1885 newel posts of the portico stair were replaced with columnar ones (Ill. 48). The rear, north entranceway was reduced to a window (Ill. 49), and the portico here was apparently discarded. However, the balustrading survived the move intact, and the southwest corner of the west piazza had not yet been truncated.

Inside, elements were rearranged to accommodate the change of entranceways. Illustration 50 shows the work that was done. It is accurate in all respects except for the inclusion of the doorway at the north end of the west piazza. (Recent physical investigation has shown that this door was not added during the 1889 renovations, but rather between 1903 and 1912.) Essentially, the main stair was taken down, as were

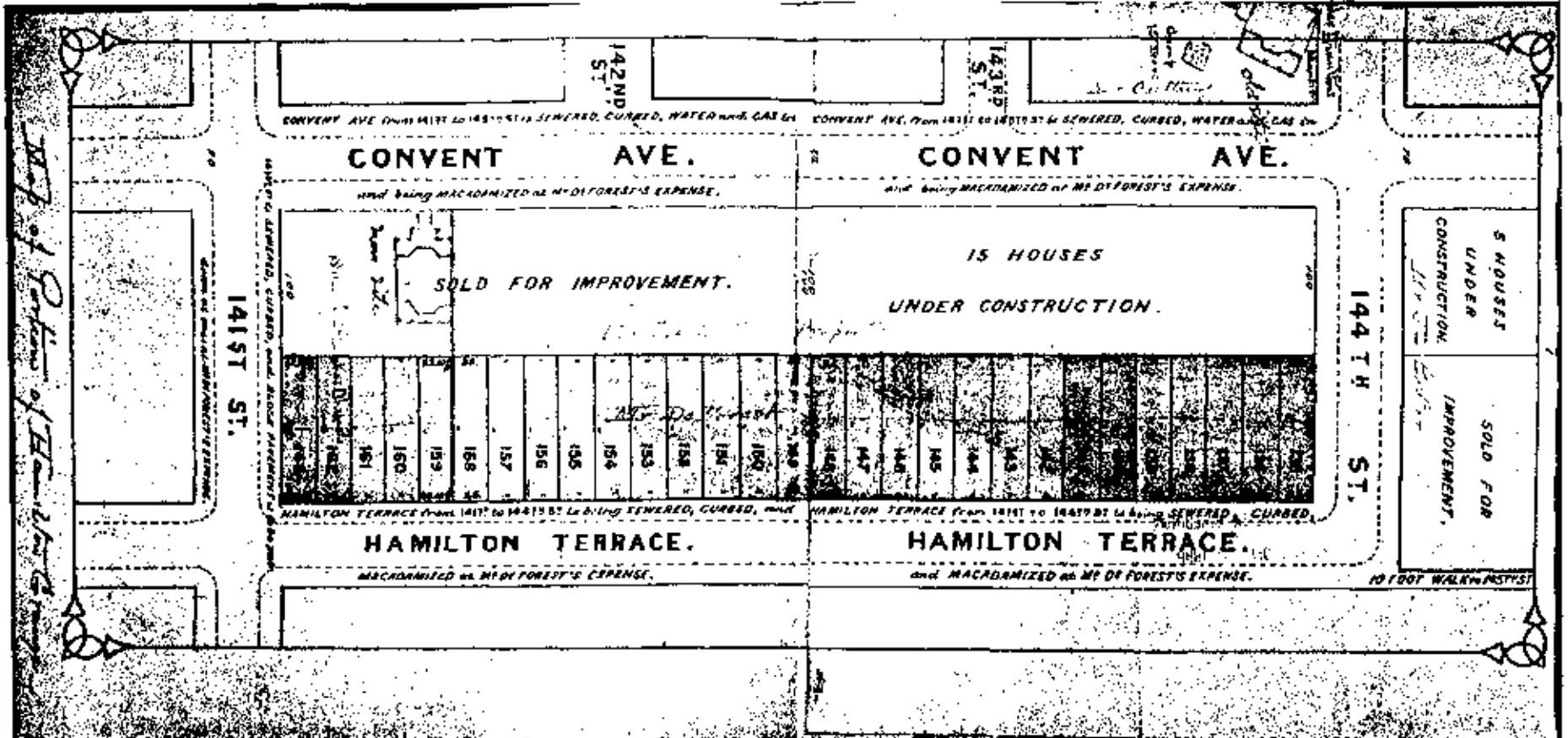

Illustration 40. The Grange: Relocation Plan (1888).

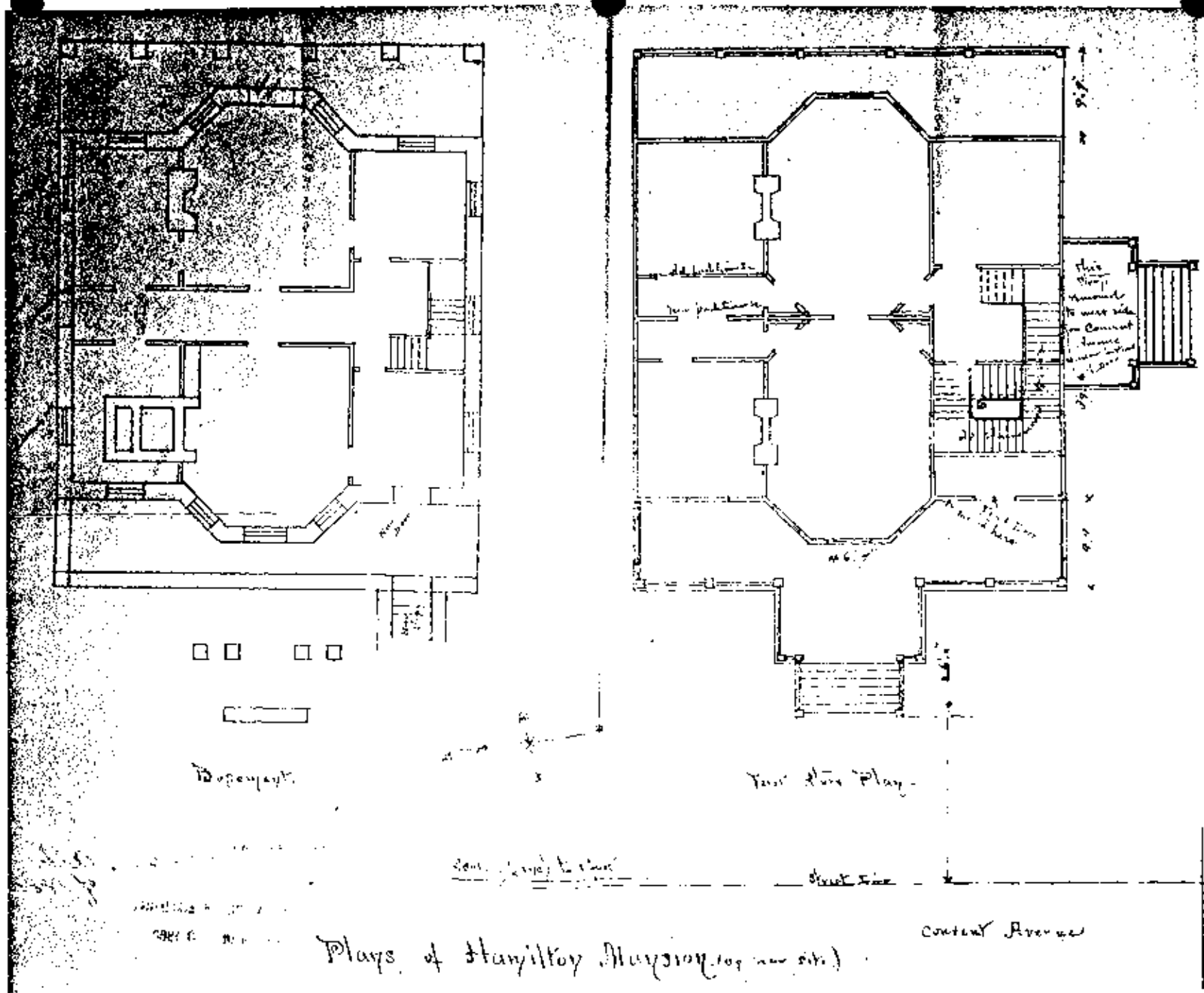

Illustration 41. The Grange: Basement and First-Floor Renovation and Alteration Plans (December 3, 1888).

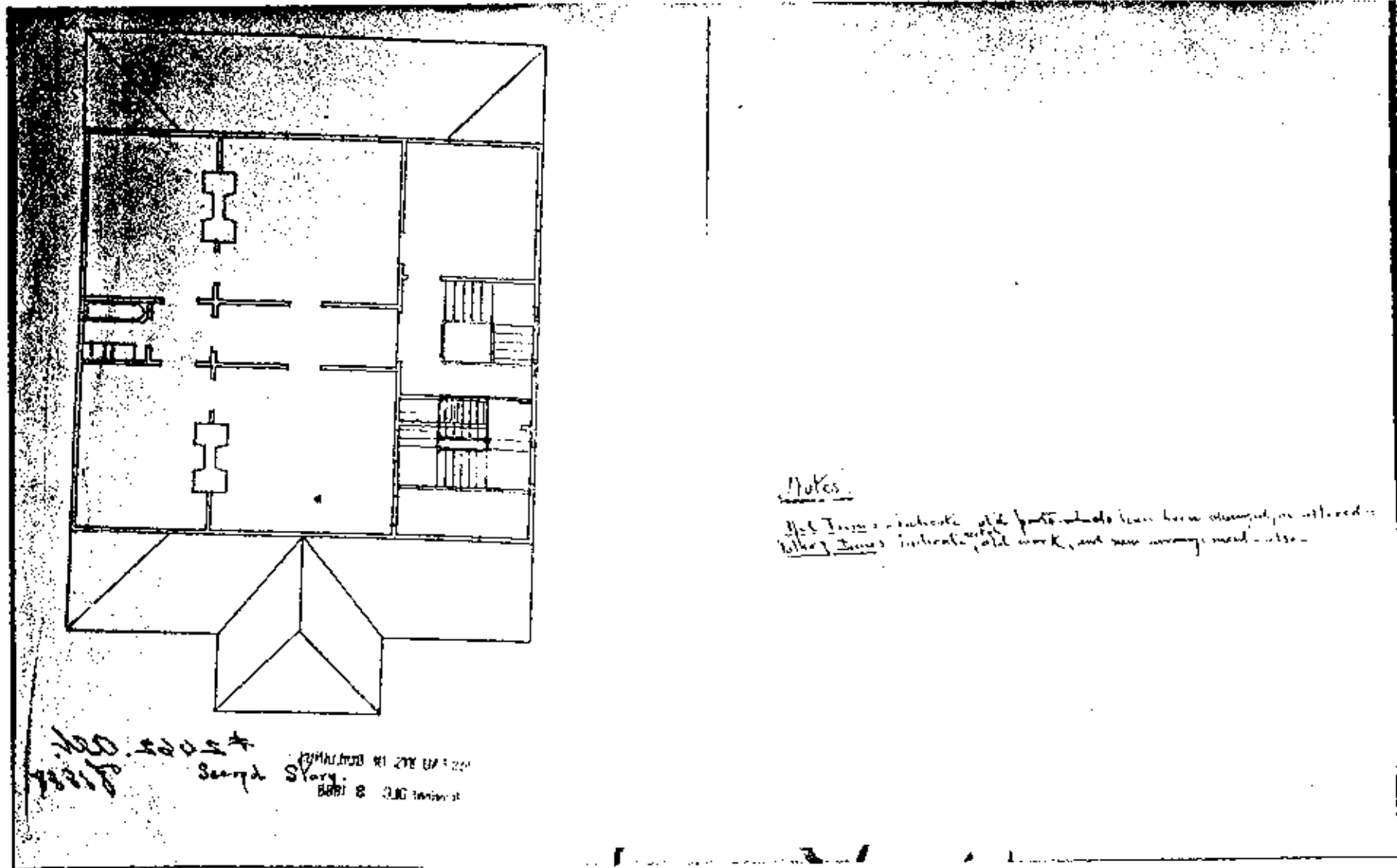

Illustration 42. The Grange: Second-Floor Renovation and Alteration Plan (December 3, 1888).

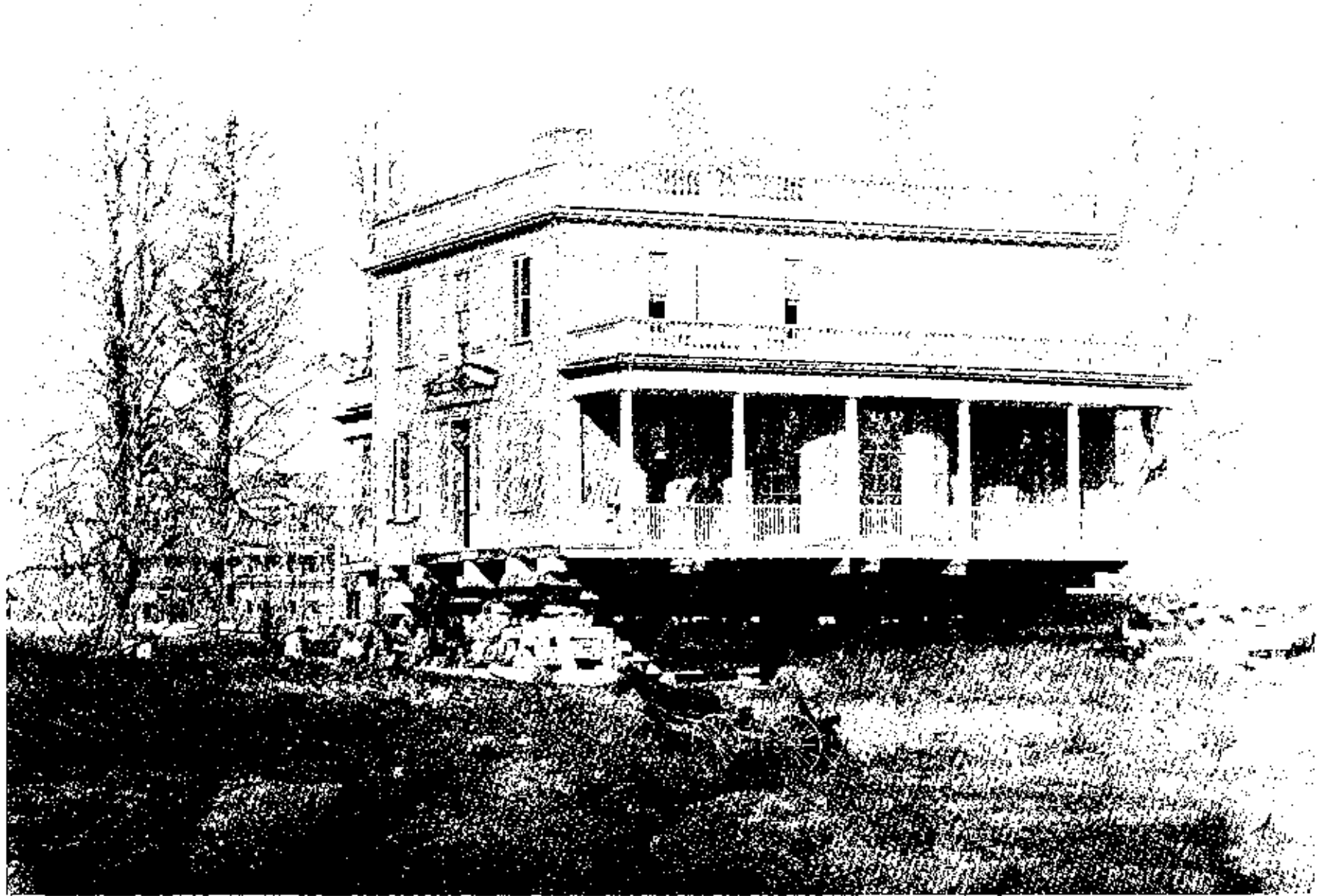

Illustration 43. The Grange: Just Prior to Moving (1888).



Illustration 44. The Grange: Just After Moving (spring 1889).



Illustration 45. The Grange: West Elevation,
Relocated Main Entrance (1955).

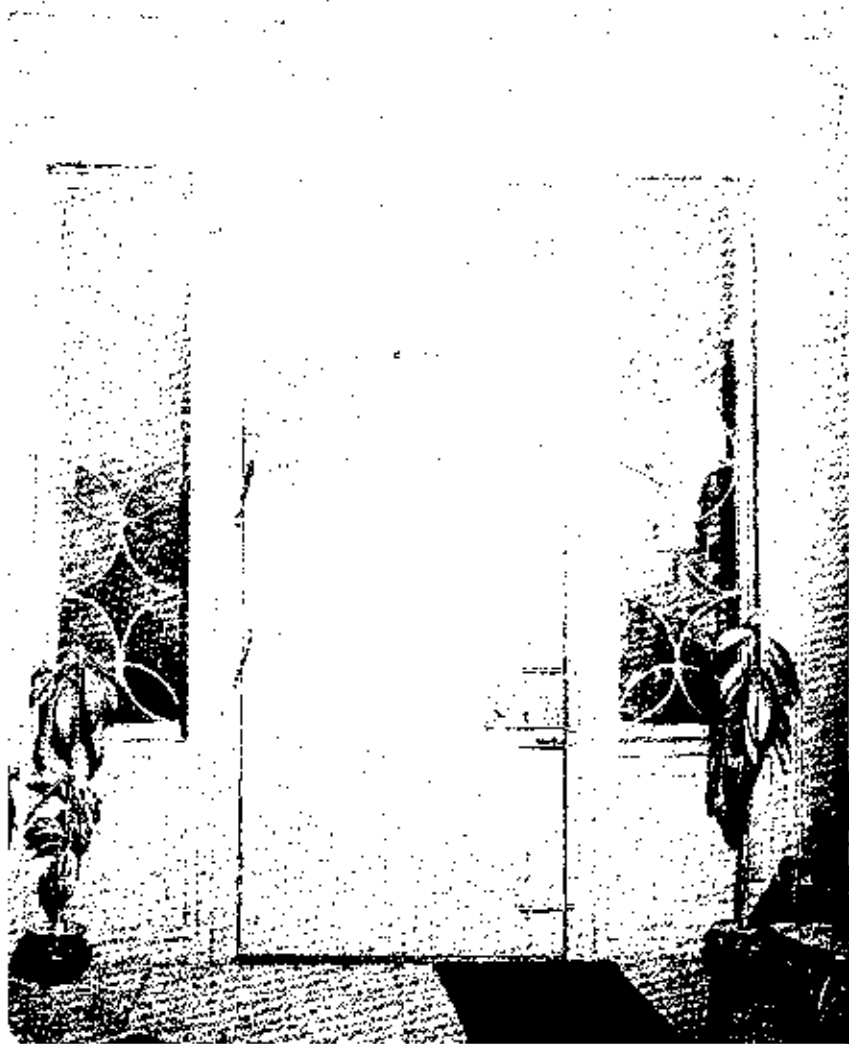

Illustration 46. The Grange: Interior View of Relocated Main Entrance.



Illustration 47. The Grange: After Relocation (1889, view southeastward from original to relocation sites).



Illustration 48. The Grange: West Elevation with Relocated Entry Portico (1889).



Illustration 49. The Grange: West and North Elevations (c. 1889-1890).

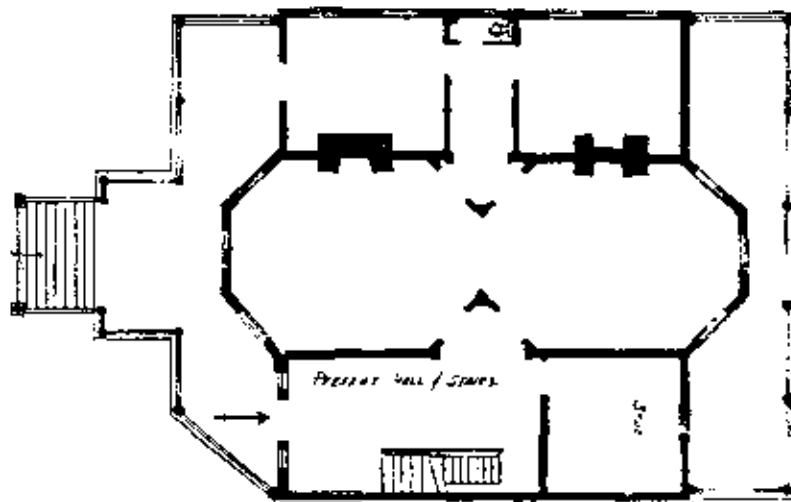

FIGURE 2. The main floor plan as it now exists.
Courtesy Major Alexander Hamilton.

Illustration 50. The Grange: First-Floor Plan Showing 1889 Alterations.

the walls dividing the original entry hall, stair hall, and southwest closet. This created one large hall (Ils. 51, 52). The main stair was then rebuilt (Ill. 53) at the eastern end, in the area of the old entry hall. (The first run of stairs traverses diagonally the location of the original door front.) The new stair had fewer turns and landings than the original one did, because of the additional room that had been made available. Below the main stair, a new stair to the basement was built.

At the opposite end of the house, the original back door was replaced by a window (Ill. 54).

The second-floor stair hall and landing, in front of the tripartite window that formed the upper part of McComb's original Grange entrance, are shown in Illustration 55. A door is seen at the extreme left of this photograph. The door leads to the attic stair, which — together with the doorway itself — was placed in this location during the 1889 renovation. In the original construction, the attic stair occupied the southwest corner of the second-floor southeast room. Evidence of this is contained in the fabric of the structure, as explained in the Architectural Data Section, Chapter III, Section D, "Southeast Room."

The work of renovation advanced sufficiently such that the first service in the Grange — in its role as the chapel of St. Luke's Church — was celebrated on April 28, 1889.[12] The weather was rainy, and a damp chill was in the air. The Rev. Tuttle, who was suffering from a cold, remained regretfully at home. (The donor of the Grange, Amos Cotting — 62 years old at the time — appeared as promised, expecting to meet the Rev. Tuttle at the service. From this exposure, Cotting became ill, and he died on May 12.[13]) Much was made at that first service of the fact that two days later, the centennial of the first inauguration of President Washington would be commemorated.

The service itself was held in the two octagon rooms, which were used together as one large hall[14] (Ill. 56). This arrangement continued during the construction of the church building proper (Ill. 57), which required the removal of the southwest corner of the Grange's west piazza to make room for the church's front arcade. Use of the Grange as a chapel was terminated when the new edifice was completed on December 18, 1892 (Ils. 58, 59). At this point, the Grange became the church rectory. As seen in Illustration 60, the west octagon room reverted to its original use as a drawing room. This photograph could have been taken anytime between 1892 and 1909, but it probably favors the former, since the decor is the same as when the room was used as a chapel. Illustration 61 shows the entry hall at this time.

By 1894, the Grange was in need of repairs.[15] Most importantly, an entire new roof was necessary. A feeling prevailed among the vestry that the structure was not worth preserving. However, the Rev. Tuttle — partly because of his devotion to the Grange for its link with Hamilton — was convinced that the house repaired would continue to be useful for many years. He finally paid for a new roof from his own funds: the cost was \$1,500.[16] The Rev. Tuttle died in November 1896. From about that time until the spring of 1909, at least part of the basement or first floor was utilized as a day school, conducted by a Mrs. Ella K. Morgan.[17]

Illustration 62 shows the Grange in 1897. Traces of the lost north portico are visible over the middle first-floor window — the one that replaced the former north door. The present side door at the north end of the west wall has not yet been installed. It is still lacking in Illustration 63, but the continued presence of Mrs. Morgan's "Hamilton Grange School" is evident.

The side door — or at least its box-like storm porch — first appears in Illustration 64. This photograph can be dated between 1909 and 1912: the day-school sign has disappeared, but the American flag over the portico features the 45-star pattern used before 1912. Exterior and interior views of the side doorway are Illustrations 65 and 66.

The summer of 1909 saw the interior of the Grange redecorated throughout, and the entire exterior painted (Ill. 67). The second floor thenceforth was occupied as living quarters, while first-floor rooms became office space and meeting rooms. [18]

In 1914, changes again were made in the house. The basement was fitted up for the use of the sexton's family, while the two floors above were renovated as quarters for the rector. The two north corner rooms on the first floor, serving as offices, were converted into a kitchen and a servant's room. The two octagon rooms once again were returned to their original function of parlor and dining room. The exterior of the structure was painted white, the blinds were painted green, and the grounds in front and rear put in good condition. [19]

The pragmatic relocation of the Grange structure did not provide for the salvation of the only other vestige of Hamilton that remained in 1888 -- the 13 trees that he had planted as a symbol of the original states of the Union. The property on which the trees continued to grow was purchased in 1892 by an ex-Congressman, Orlando B. Potter, who announced that they would be unmolested so long as they continued to live. [20] Their appearance about a year later is seen in Illustration 59. Potter's statement proved to mean that the trees were safe so long as he lived, because after his death in 1898, his son put the lot up for sale. [21] Despite continued threats to their existence, the trees continued their lonely vigil. [22] At 3:30 p.m. on July 12, 1904, they received their last formal homage: the American Scenic and Historic Preservation Society -- in cooperation with the New York State Society of the Cincinnati and other patriotic organizations -- conducted at the site of the trees a public commemoration of the centennial anniversary of the death of Alexander Hamilton. [23] The last fragments of the last surviving trees were removed in 1908. [24] And by 1920, the city street pattern had digested fully the formerly suburban Grange neighborhood. Illustration 68 shows this clearly; only a small section of the Bloomingdale Road -- renamed Hamilton Place -- remains. One relic of the early period did manage to survive intact, though: a movement in 1898 to relocate the Morris-Jumel Mansion -- inspired by the move of the Grange -- came to naught. [25]



Illustration 51. The Grange: West End of Present Entry Hall (1955).



Illustration 52. The Grange: East End of Present Entry Hall (c. 1889-1892).



Illustration 53. The Grange: Present Main Stair (1955).



Illustration 54. The Grange: Location of Original Rear Doorway, First-Floor North Hall (1964).



Illustration 55. The Grange: Center and Front Halls, Showing Present Location of Attic Stair (1962).



CHURCH IN HAMILTON GRANGE

Tuttle, Mrs. H. Groswell, History of Saint Luke's Church,
opp. page 218

Illustration 56. The Grange: Eastward View of Octagonal Rooms in Use as Saint Luke's Church (c. 1889-1892).



THE GRANGE, AS IT IS TODAY.

The building in course of erection is St. Luke's Church.

Illustration 57. The Grange and Construction of Saint Luke's Church (c. 1892).

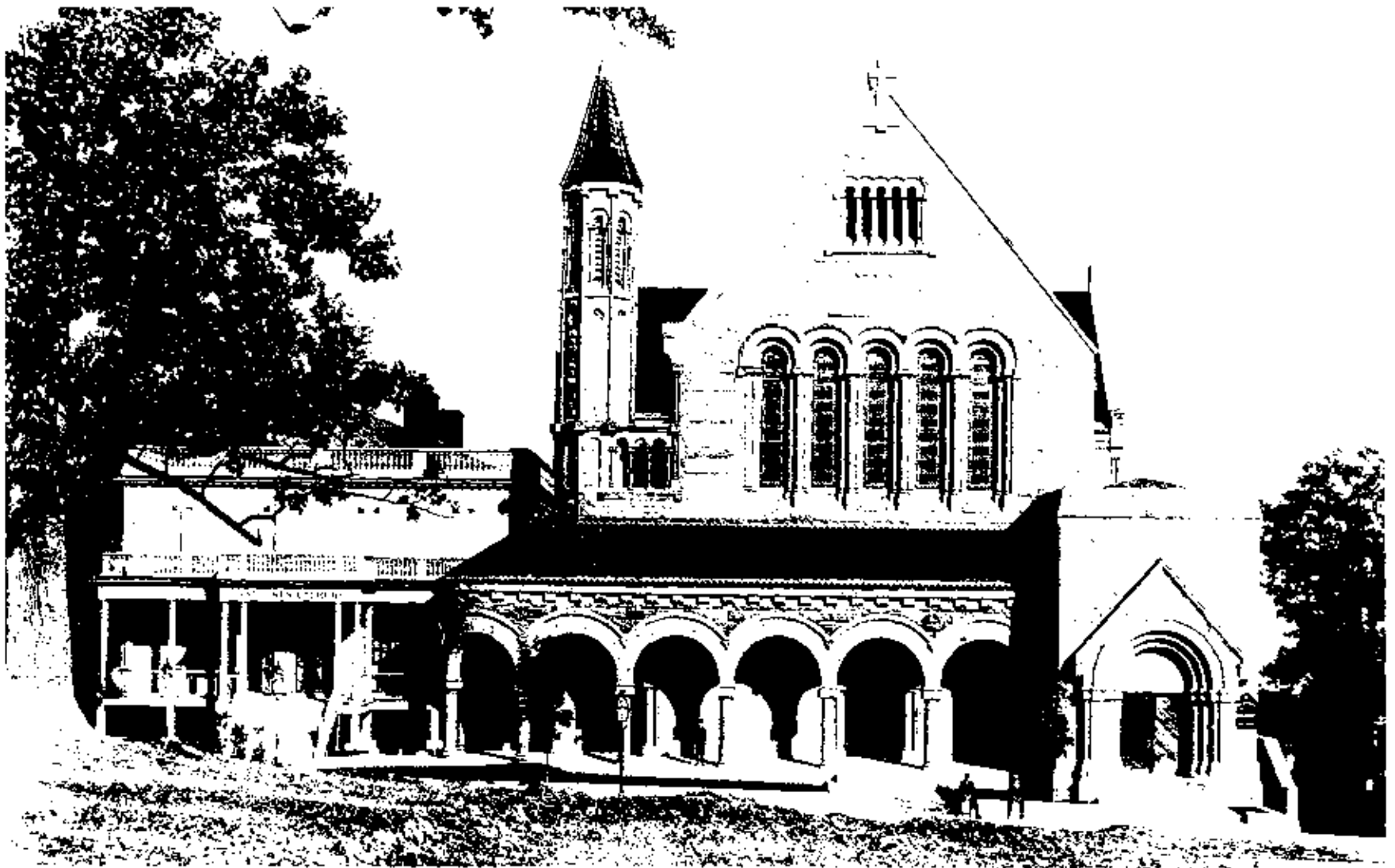

Illustration 58. The Grange and Completed Saint Luke's Church (c. 1894).



Illustration 59. The Grange and Completed Saint Luke's Church (c. 1893, view southeastward from original to relocation sites).



Illustration 60. The Grange: West Octagon Room in Use as Rectory Drawing Room (c. 1892).



Illustration 61. The Grange: East End of
Entry Hall (c. 1892-1909).

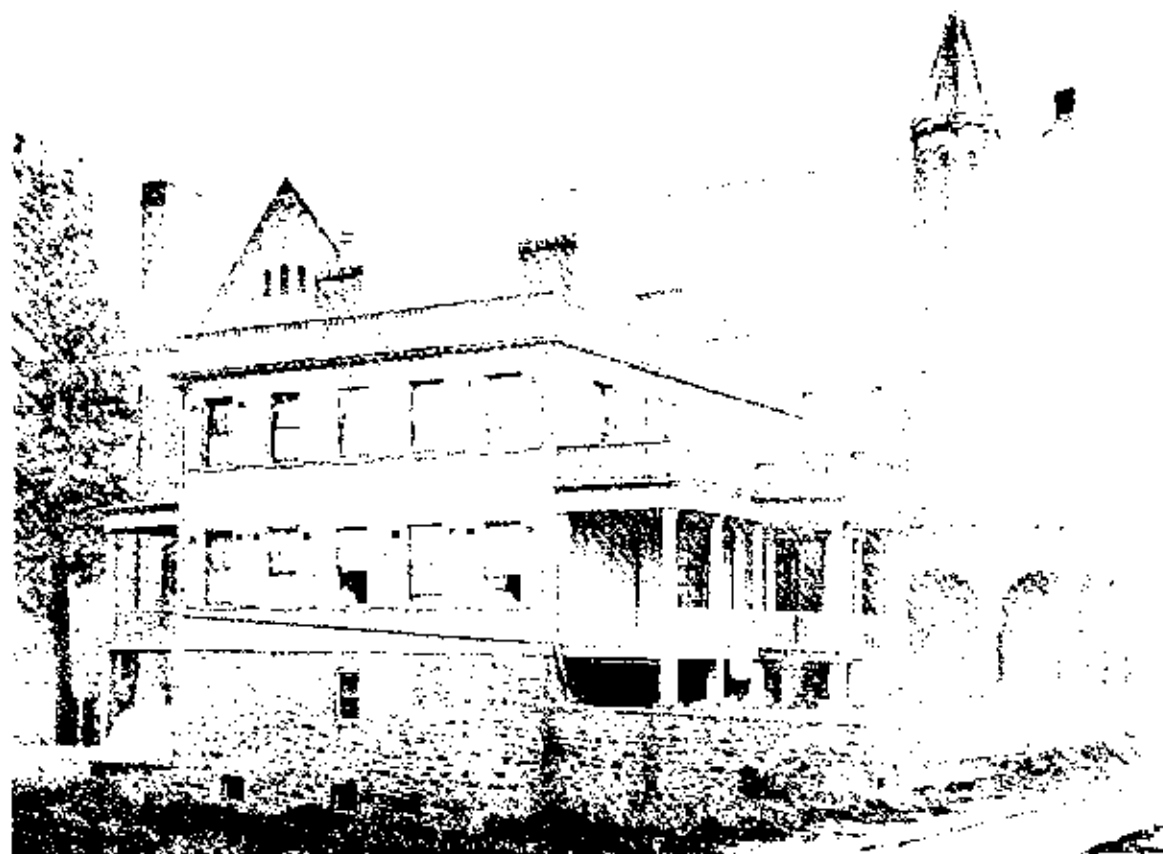

Illustration 62. The Grange: North and West Elevations, Showing Location of Original Rear Door (1897).



Illustration 63. The Grange: South Elevation (c. 1903).



HAMILTON GRANGE
View of the West End

Illustration 64. The Grange: North and West Elevations
(c. 1909-1912).

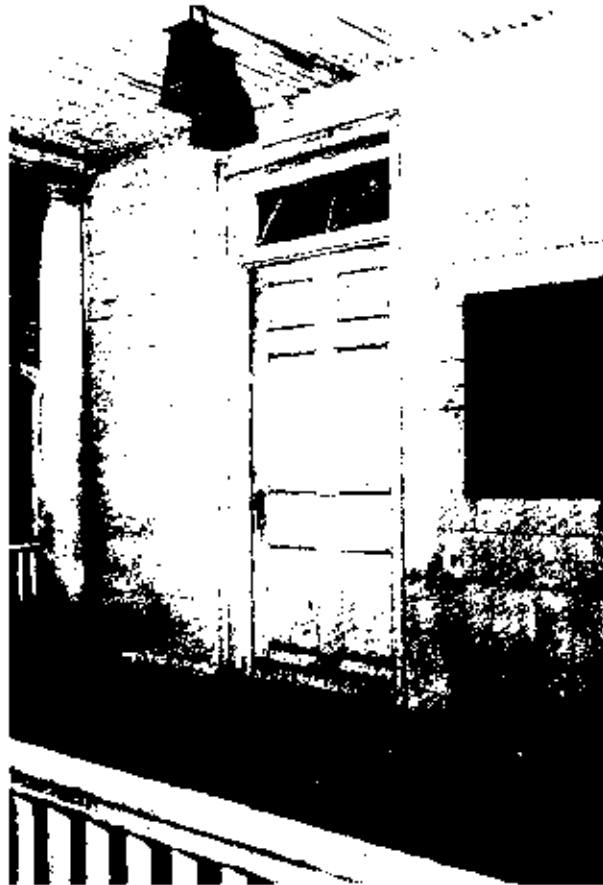

Illustration 65. The Grange: Side Door,
Exterior View.



Illustration 66. The Grange: Side Door,
Interior View (1964).



Architectural Record, The Grange, 1912, p. 102.

Illustration 67. The Grange: North and West Elevations
(1912).

NOTES

1. See, for example, New-York Tribune, Apr. 10, Oct. 16, 1887, Sept. 1, Nov. 10, 1889; New-York Post, Mar. 13, 1889.
2. Raymond H. Torrey, "Hamilton Grange," S&HA, III, No. 3 (Apr. 1934), p. 18.
3. Mrs. H. Crosswell Tuttle, History of St. Luke's Church in the City of New York 1820-1920, pp. 207-210, 215-216.
4. Ibid., pp. 210-211, 217, 563.
5. Ibid.
6. Ibid., p. 217.
7. Ibid., pp. 210-211.
8. Ibid., p. 217.
9. Ibid., p. 212.
10. Martha J. Lamb, "Historic Homes and Landmarks: Their Significance and Present Condition," Magazine of American History, XXI, No. 1 (Jan. 1889), p. 6.
11. AS&HPS correspondence files.
12. Tuttle, St. Luke's, pp. 218-219.
13. Ibid., pp. 218-219, 563; Evening Post, May 13, New-York Daily Tribune, May 14, 1889.
14. "...On the first floor the two connecting rooms formerly used as a dining room and a reception-room are now occupied as a chapel." New-York Tribune, Apr. 20, 1890.
15. Tuttle, St. Luke's, p. 280.
16. Ibid., pp. 280-281.
17. Ibid., pp. 306, 335.
18. Ibid., p. 338.
19. Ibid., p. 398.
20. "Hamilton's Thirteen Trees," Apr. 23, 1892, pp. 465-466.
21. "Hamilton Trees For Sale," New York Times, Jan. 19, 1898.

22. See, for example, "Hamilton's Trees to Go," New York Times, Nov. 27, 1899.
23. AS&HPS, "Alexander Hamilton Centennial," Tenth Annual Report (1905), pp. 20-21.
24. AS&HPS, "Last of the Hamilton Trees," Fourteenth Annual Report (1909), pp. 80-84; I.N. Phelps Stokes, The Iconography of Manhattan Island, III, p. 775.
25. New York Times, Feb. 11, 1898.

VII. PRESERVATION EFFORTS

A movement was begun in 1901 to preserve Hamilton Grange and to establish it as a memorial to the accomplishments of Alexander Hamilton. Through efforts of the Alexander Hamilton Post, G.A.R., of New York City, a bill was introduced into the state legislature for the purchase of the house and the original site, and for the restoration of the Grange upon it. The bill failed of enactment, but the movement — which had simmered for a decade — had begun to take positive steps toward a meaningful result.[1] That same year, the possibility of a Hamilton memorial incorporating the Grange came to the attention of Dr. Edward Haganan Hall, the newly installed Executive Secretary of the American Scenic and Historic Preservation Society. Dr. Hall then was preparing the second of his distinguished Yearbooks of the Scenic Society, which would be graced by his authorship for the next three decades. He noted the beginnings of the Grange preservation movement, and annually kept the matter in print. In the Yearbook for 1912, he summarized the movement to that date.[2]

Dr. Hall was far more than just a commentator upon that early scene of historic preservation, however: he was one of the pioneers of the movement. He often acted upon matters about which he had written, and did so especially in the case of the Grange. On January 12, 1912, Hall initiated a correspondence with the Rev. George Ashton Oldham — then rector of St. Luke's Church — beginning:

For many years this Society has been interested in the preservation of the Hamilton Grange as a public monument....[3]

and requesting information as to the feelings of the church authorities in the matter. The reply was not encouraging, but Hall persisted, writing again on January 20, to ask:

...at what price would the parish part with the Hamilton House? I do not know whether the City or individuals could be persuaded to provide funds for this, but the first step in this direction would be to find how much would have to be raised. If you can give us an intimation on this subject, we would be glad to place the information where it will do the most good.[4]

Oldham responded, reluctantly and unofficially, that \$30,000 might be considered.[5] Thus began 12 years of negotiations, broken off during World War I, that culminated in the acquisition of the Grange by the Scenic Society in 1924. During the summer of 1923, a six-story apartment house was built on the contiguous lot north of the Grange, hemming in the structure and making it, for all intents and purposes, a row house.[6] Illustration 69 shows the front of the Grange in this straitened condition; Illustration 70, the rear of the structure.

Conveyance of the property — both the building and the ground beneath it — from the church to the American Scenic and Historic Preservation Society was concluded on November 17, 1924. Consideration was \$50,000, a gift from J.P. Morgan and George F. Baker, Jr.[7] The deed was recorded in the office of the Register of New York County on November 19, 1924, on page 53, liber 3452 of Conveyances, and indexed under block number 2050 on the county land map. Morgan and Baker also established a trust fund in the principal amount of \$50,000, the income to be paid to the society toward the maintenance of the Grange "as a public museum for the education and benefit of the general public." [8] Illustration 71 may show the first floor at this time.



Illustration 68. The Grange: East End of Entry Hall, Apse, and East Octagon Room (probably after 1912).

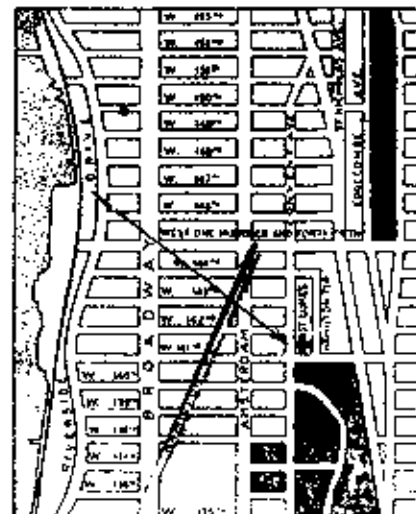

MAP OF THE NEIGHBORHOOD OF THE NEW CHURCH

Tuttle, Mrs. H. Croswell,
History of Saint Luke's Church,
 pp. 22-23.

Illustration 69. The Grange Neighborhood (c. 1920).



Illustration 70. The Grange: West Elevation and Adjacent Apartment Building (1964).



Illustration 71. The Grange: East Elevation and Adjacent Buildings (1955).

The Scenic Society maintained and operated the Grange in keeping with the terms of this trust, from 1924 until 1962, when the Grange was accepted by the U.S. Government for administration by the National Park Service. The administration of the Grange by the Scenic Society was predicated upon three main courses of activity. First, it operated a museum, in keeping with the terms of the Morgan-Baker endowment. Secondly, it made necessary repairs to the building so as to preserve it with a minimum of intrusion upon, or replacement of, the original fabric of the structure. These two lines of activity looked toward the third, which was a continuing campaign to move the Grange to an appropriate site and restore it as a national memorial to Alexander Hamilton.

Soon after the Scenic Society took title to the Grange, Dr. Hall made a plan of the first and second floors (Ill. 72) as they existed at that time. Sketch plans of the upper three floors -- probably done about this time -- also exist, but they mix original, later, and conjectural elements badly (Ill. 73).

In 1929, the structure was reroofed with 16-ounce copper sheeting.[9] The roof balustrading was removed as an item in this contract.[10] In 1932-1933, an ambitious program of repairs and renovation was executed, under the guidance of Alexander McMillan Welch and the management of Archibald D. Anstey. The work accomplished put the structure very much in the condition that it exhibits at the present time, excluding normal wear and tear in the interim. Anstey's 1932 plan for installation of electrical wiring is Illustration 74. A file of estimates and bills from the work supervised by Anstey over a six-month period relates in some detail the specifics of the job. Nearing the end of the job, the funds were short, so only the front of the building was painted (Ill. 75), rather than all four sides. One unfortunate consequence of this work was that the eaves balustrades of the main roof, piazzas, and portico were lost -- taken down to facilitate repairs and painting, and never replaced.[11] The Grange was subsequently opened as a museum of Hamiltonia, while efforts continued and increased to achieve the long-range goal of the society -- a suitable memorial, on a different site, to Alexander Hamilton. An appraisal that describes the structure in detail as it was after the 1932-1933 renovation, is Appendix E of this report.

In 1936, a new element was added to the Grange scene: a larger than life-size statue of Alexander Hamilton. This statue had been created in France in 1892-1893 by William Ordway Partridge for the Hamilton Club of Brooklyn. It had graced the entrance of the club on Remsen Street in Brooklyn from 1893 until the club dissolved in 1936. An extensive file relating to the statue, including the original agreement for its sculpture, is among the holdings of the Scenic Society. Illustration 76 depicts the removal of the statue from its Brooklyn site, while Illustration 77 shows it resettled at the Grange.

The history of the Grange since 1924 is replete with efforts to relocate it for restoration purposes. Most of these have been almost, but not quite, successful. One positive result has been a statement of criteria for possible relocation sites. This was spelled out in a letter written June 22, 1951, to Montgomery Schuyler by Talbot F. Hamlin, the late Avery Architectural Librarian at Columbia University and distinguished architectural historian:

The more I consider the problem of the future of Hamilton Grange, the more I feel that the site problem is the crux of the whole matter.

Let us first consider the qualities of the ideal site:

1. It should be easily available to museum visitors.
2. It should be not too far from the original site in order to preserve some historical continuity.
3. It should have some of the topographical qualities of the original site - high position, view, etc.
4. It should be a site to permit the architectural quality of the house to be visible. The house was built as a country mansion.

As I can see it, there are two possible sites which very nearly approach this ideal. The first (originally suggested, I believe, by Eric Gugler) is on the grassy swale south of the Cloisters and just north of the eminence of Fort Tryon. The second is north of the Chinese monument just back of Grant's Tomb, and slightly south of Robert Moses' "sitting park" on the old Claremont Inn site.

Both of these are, from the topographical and visual angles, almost equally beautiful. The Cloisters site has the advantage of being close to another museum, and has also a view both east and west. The Grant's Tomb site, on the other hand, has the advantage of being closer to the center of town and is more easily accessible. Thus I see little difference between them; either would be magnificent and would make Hamilton Grange a great asset to the city's public beauty as well as to its educational wealth.

One other site has been suggested by various city authorities -- that on the new Manhattanville campus of City College. This site could be excellent; but the "could" depends on many factors -- the group plan developed for the new CCNY buildings, the attitude of the college authorities, etc. It has the advantage of closeness to the present site, so that the cost of moving would undoubtedly be less than in the case of the two "ideal" sites.

The desirability of this site is thus still problematical. If a sufficient space for lawn and trees could be guaranteed around it, to insulate it from the hurly burly of the College, and if the College authorities could accept it enthusiastically as a museum pure and simple, then this site might be not only practicable but also desirable. Much would depend on the attitude of the history and art departments of the College, as well as on its administration; the final criterion, however, might be the governing site plan of the college additions. I have been told that it is the city's aim to preserve as much as possible of the rural charm of the present condition.

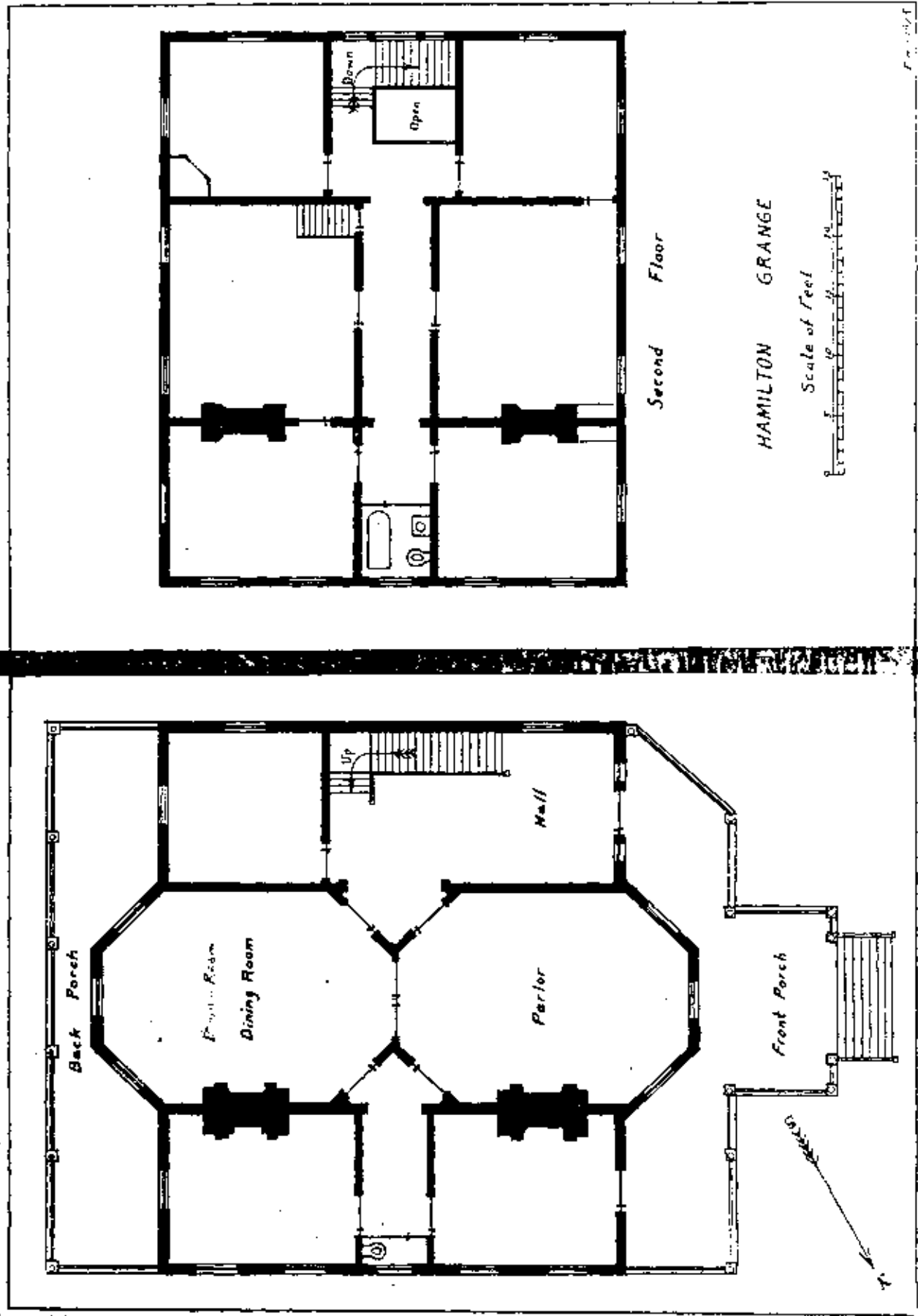

Illustration 72. The Grange: Plan of First and Second Floors (1925).

Hamilton's Grange

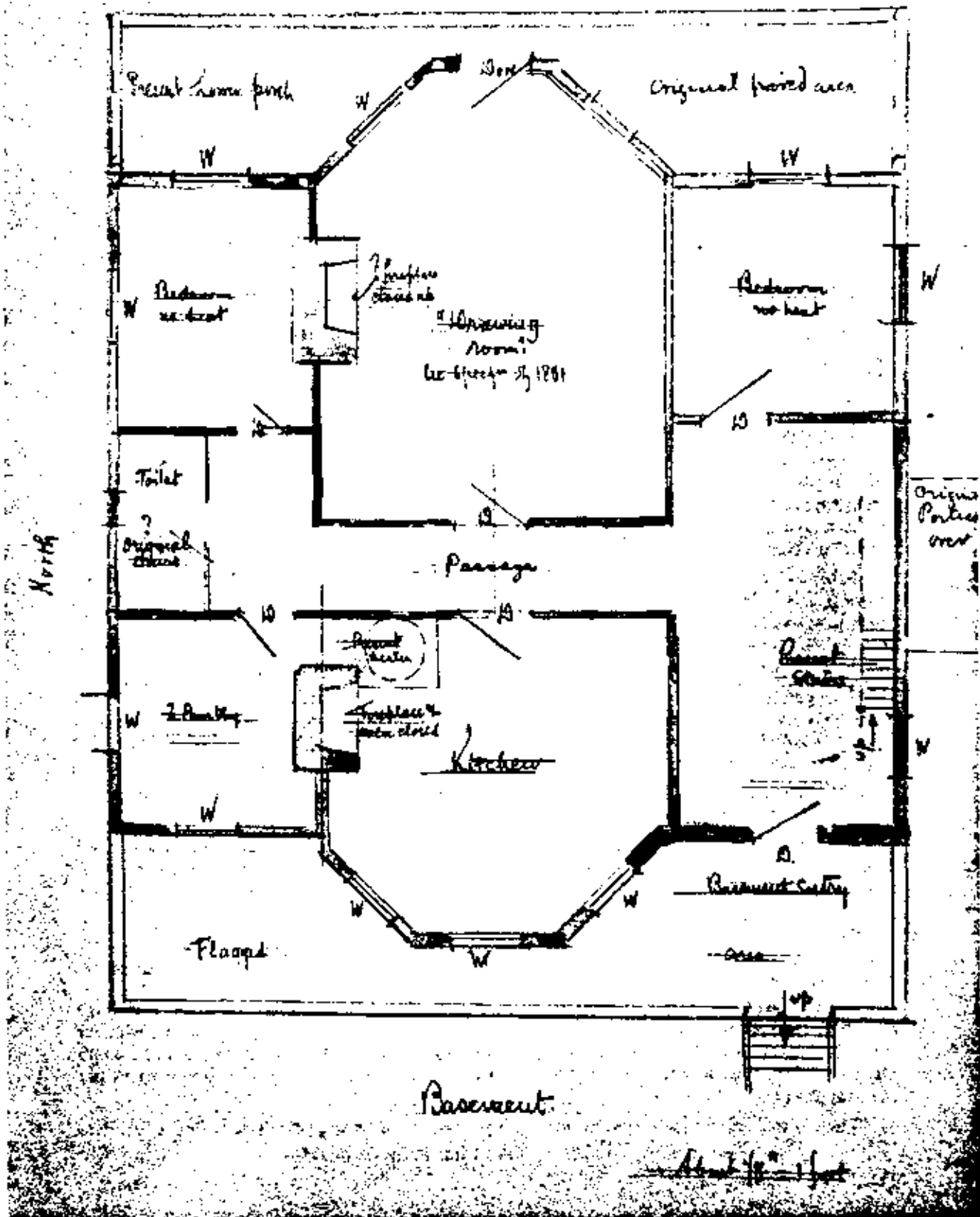
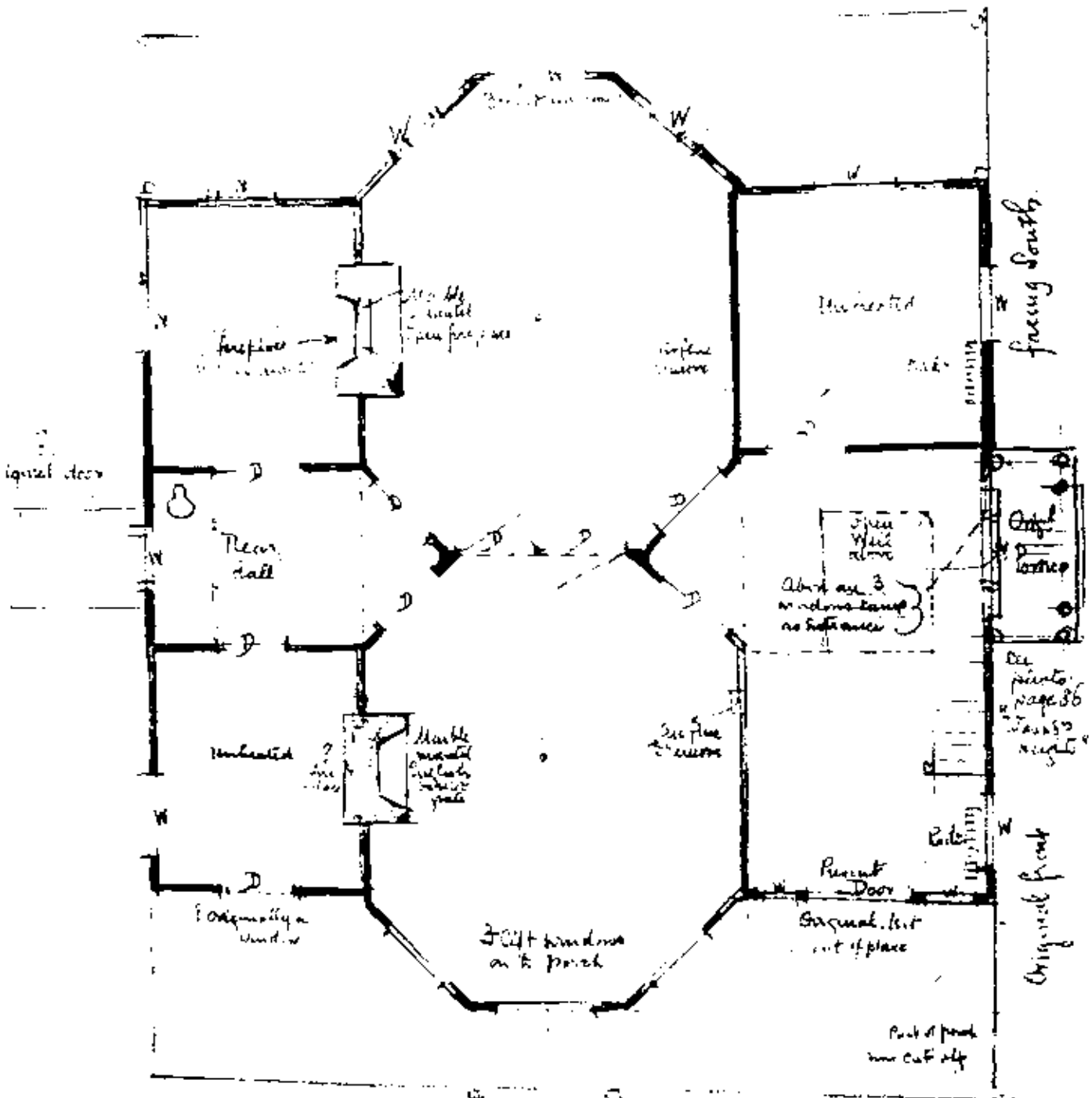

Illustration 73. The Grange: Plans of Basement, First, and Second Floors (c. 1925-1930: original, later, and conjectural elements).

Handwritten title or notes at the top of the page.

Handwritten text below the title.

Handwritten text on the right side of the top section.



equal doors

fireplace

Heated

Unheated

Rear hall

See floor to ceiling

Unheated

3 ft windows on the porch

Original front

Facing South

Original front

Part of porch now cut off

See page 36

Handwritten notes at the bottom of the diagram.

Hamilton Garage

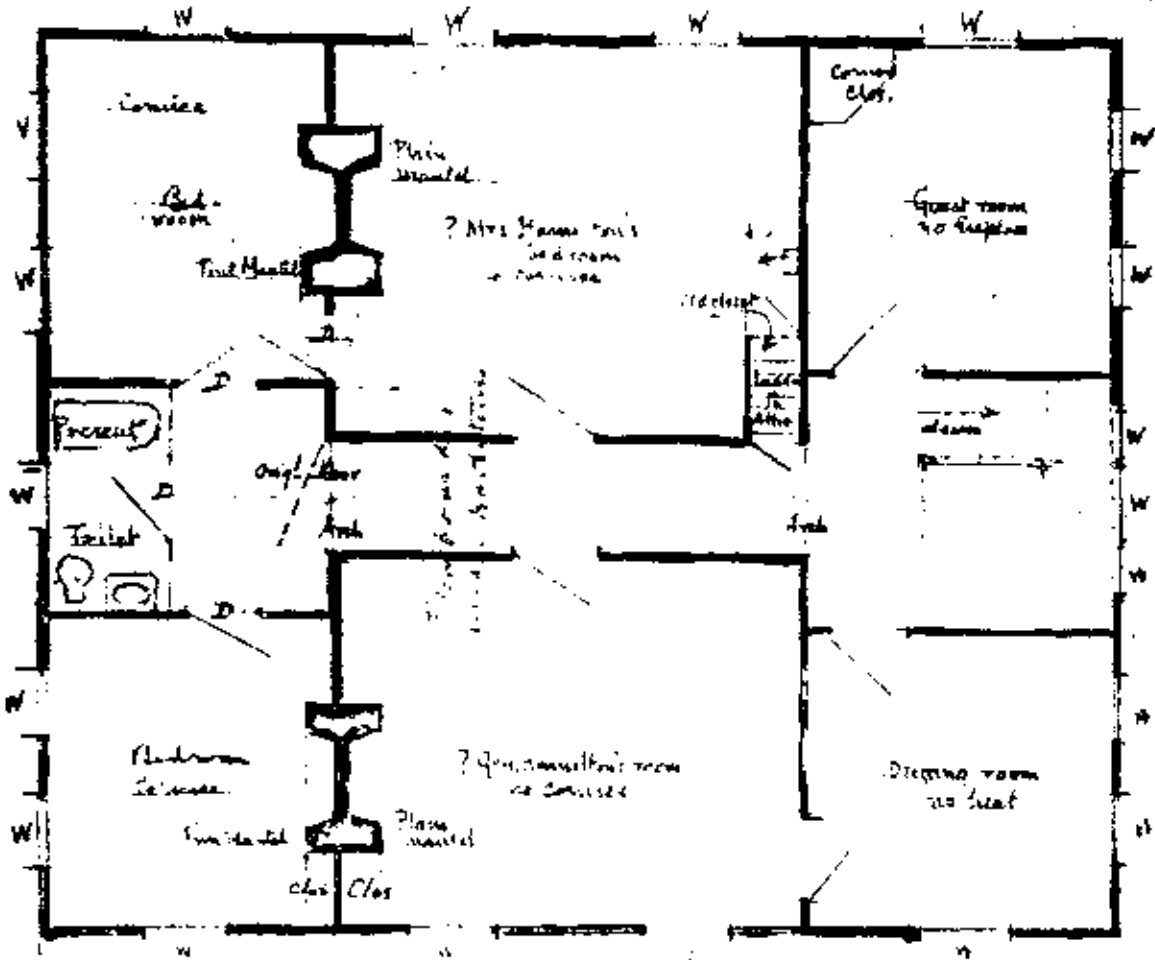

Ground floor.

Scale 1/2" = 1 foot

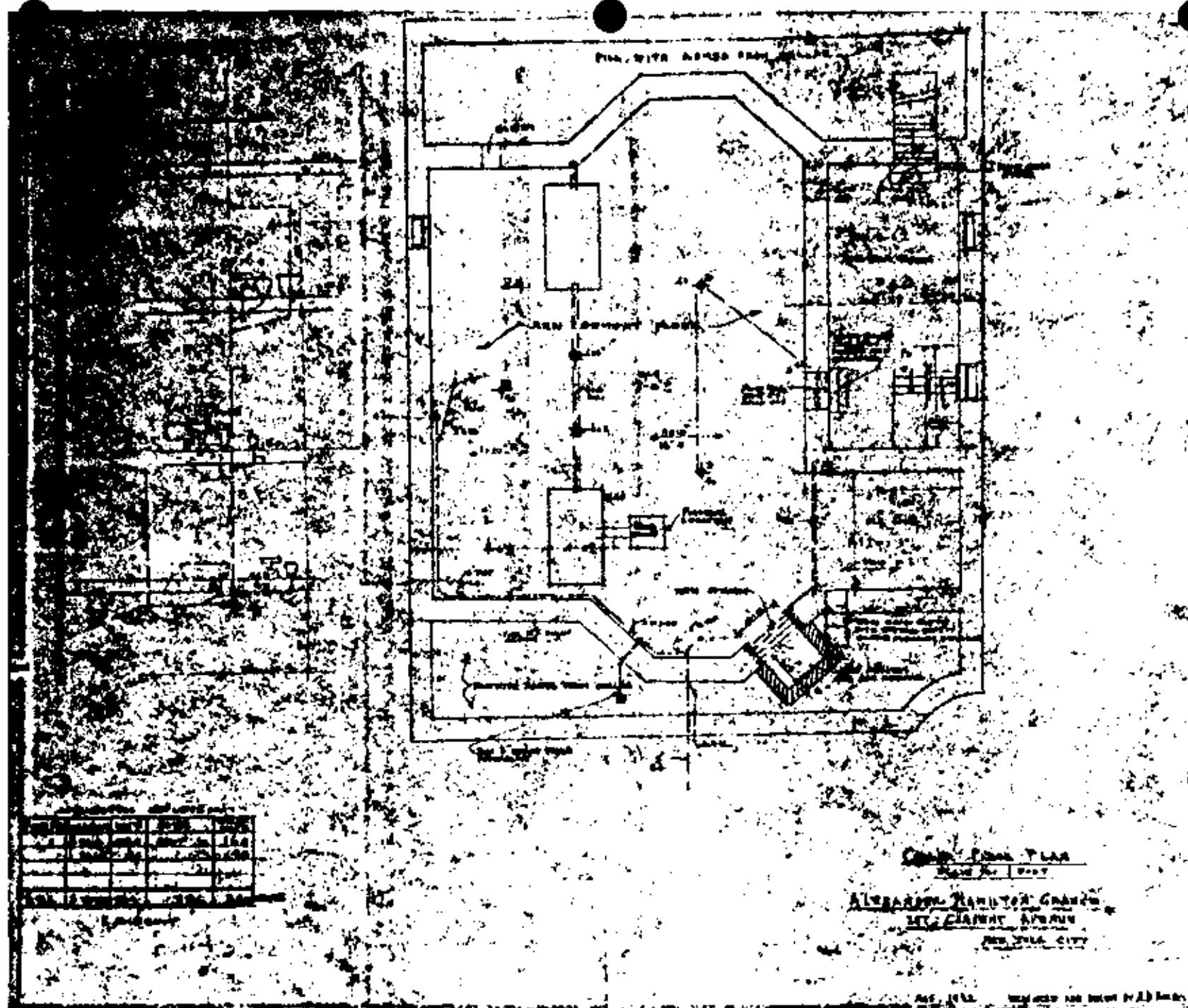
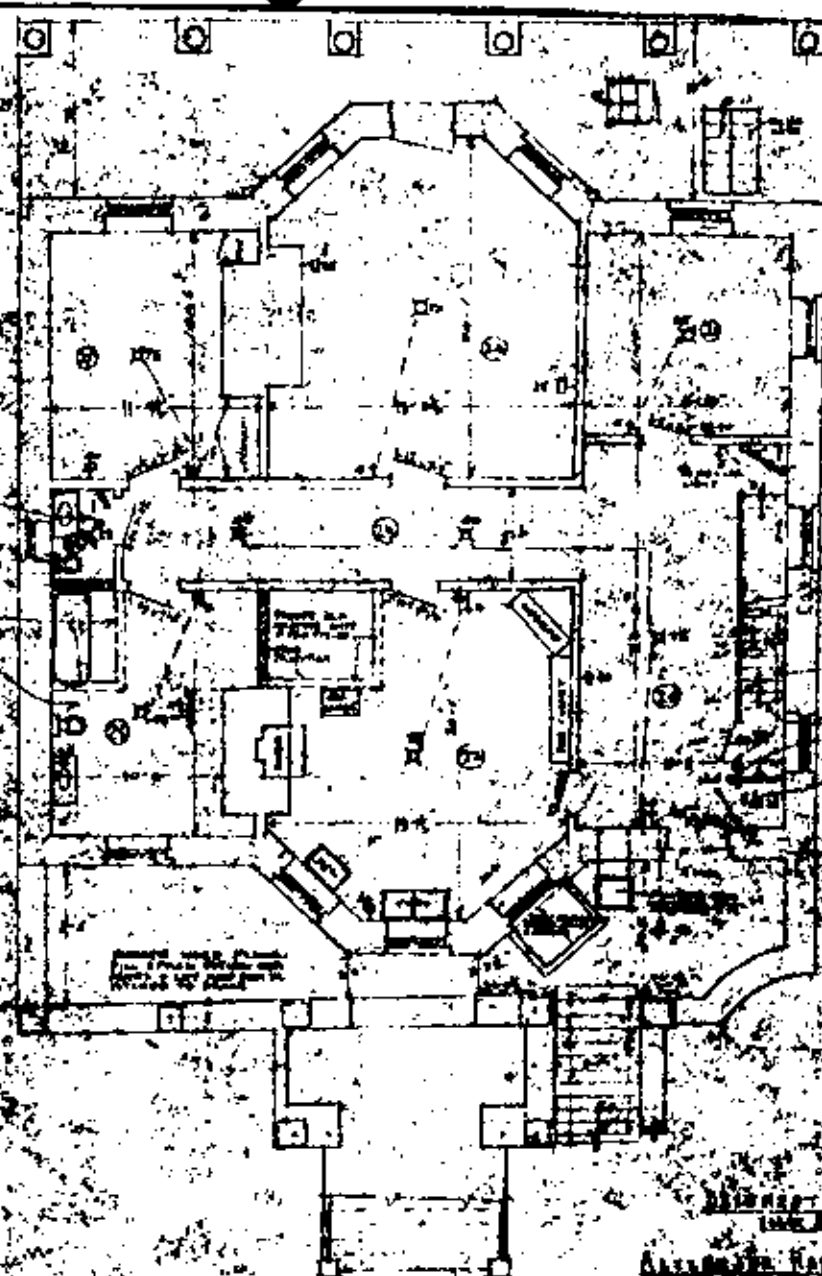

Illustration 74. The Grange: Plans of Cellar, Basement, First, and Second Floors (1932).

PLAN OF THE BUILDING

Room No.	Room Name	Area (sq. ft.)	Notes
1	Office	120	
2	Office	120	
3	Office	120	
4	Office	120	
5	Office	120	
6	Office	120	
7	Office	120	
8	Office	120	
9	Office	120	
10	Office	120	
11	Office	120	
12	Office	120	
13	Office	120	
14	Office	120	
15	Office	120	
16	Office	120	
17	Office	120	
18	Office	120	
19	Office	120	
20	Office	120	
21	Office	120	
22	Office	120	
23	Office	120	
24	Office	120	
25	Office	120	
26	Office	120	
27	Office	120	
28	Office	120	
29	Office	120	
30	Office	120	
31	Office	120	
32	Office	120	
33	Office	120	
34	Office	120	
35	Office	120	
36	Office	120	
37	Office	120	
38	Office	120	
39	Office	120	
40	Office	120	
41	Office	120	
42	Office	120	
43	Office	120	
44	Office	120	
45	Office	120	
46	Office	120	
47	Office	120	
48	Office	120	
49	Office	120	
50	Office	120	
51	Office	120	
52	Office	120	
53	Office	120	
54	Office	120	
55	Office	120	
56	Office	120	
57	Office	120	
58	Office	120	
59	Office	120	
60	Office	120	
61	Office	120	
62	Office	120	
63	Office	120	
64	Office	120	
65	Office	120	
66	Office	120	
67	Office	120	
68	Office	120	
69	Office	120	
70	Office	120	
71	Office	120	
72	Office	120	
73	Office	120	
74	Office	120	
75	Office	120	
76	Office	120	
77	Office	120	
78	Office	120	
79	Office	120	
80	Office	120	
81	Office	120	
82	Office	120	
83	Office	120	
84	Office	120	
85	Office	120	
86	Office	120	
87	Office	120	
88	Office	120	
89	Office	120	
90	Office	120	
91	Office	120	
92	Office	120	
93	Office	120	
94	Office	120	
95	Office	120	
96	Office	120	
97	Office	120	
98	Office	120	
99	Office	120	
100	Office	120	



NORTH EAST FLOOR PLAN
 SCALE: 1/4" = 1'-0"
 ARCHITECT: HAMILTON SCOTT
 111 SOUTH MAIN STREET
 NEW YORK, N.Y.

Mechanical

Room No.	Area	Notes	Value
1	25	3.00"	75
2	30	3.00"	90
3	150	1.00"	150
4	50	1.00"	50
5	150	1.00"	150
6	100	1.00"	100
7	50	1.00"	50
8	100	1.00"	100
9	100	1.00"	100
10	100	1.00"	100
11	100	1.00"	100
12	100	1.00"	100
13	100	1.00"	100
14	100	1.00"	100
15	100	1.00"	100
16	100	1.00"	100
17	100	1.00"	100
18	100	1.00"	100
19	100	1.00"	100
20	100	1.00"	100
21	100	1.00"	100
22	100	1.00"	100
23	100	1.00"	100
24	100	1.00"	100
25	100	1.00"	100
26	100	1.00"	100
27	100	1.00"	100
28	100	1.00"	100
29	100	1.00"	100
30	100	1.00"	100
31	100	1.00"	100
32	100	1.00"	100
33	100	1.00"	100
34	100	1.00"	100
35	100	1.00"	100
36	100	1.00"	100
37	100	1.00"	100
38	100	1.00"	100
39	100	1.00"	100
40	100	1.00"	100
41	100	1.00"	100
42	100	1.00"	100
43	100	1.00"	100
44	100	1.00"	100
45	100	1.00"	100
46	100	1.00"	100
47	100	1.00"	100
48	100	1.00"	100
49	100	1.00"	100
50	100	1.00"	100
51	100	1.00"	100
52	100	1.00"	100
53	100	1.00"	100
54	100	1.00"	100
55	100	1.00"	100
56	100	1.00"	100
57	100	1.00"	100
58	100	1.00"	100
59	100	1.00"	100
60	100	1.00"	100
61	100	1.00"	100
62	100	1.00"	100
63	100	1.00"	100
64	100	1.00"	100
65	100	1.00"	100
66	100	1.00"	100
67	100	1.00"	100
68	100	1.00"	100
69	100	1.00"	100
70	100	1.00"	100
71	100	1.00"	100
72	100	1.00"	100
73	100	1.00"	100
74	100	1.00"	100
75	100	1.00"	100
76	100	1.00"	100
77	100	1.00"	100
78	100	1.00"	100
79	100	1.00"	100
80	100	1.00"	100
81	100	1.00"	100
82	100	1.00"	100
83	100	1.00"	100
84	100	1.00"	100
85	100	1.00"	100
86	100	1.00"	100
87	100	1.00"	100
88	100	1.00"	100
89	100	1.00"	100
90	100	1.00"	100
91	100	1.00"	100
92	100	1.00"	100
93	100	1.00"	100
94	100	1.00"	100
95	100	1.00"	100
96	100	1.00"	100
97	100	1.00"	100
98	100	1.00"	100
99	100	1.00"	100
100	100	1.00"	100
TOTAL	100	1.00"	100

4 CIRCUITS

ELECTRIC SUMMARY

FLOOR	NO. OF	NO. OF	NO. OF
CELLAR	5	100	1
BASEMENT	14	150	2
1ST FL.	14	1000	5
2ND FL.	24	1750	4
ATTIC	5	100	1
TOTAL	62	2400	13

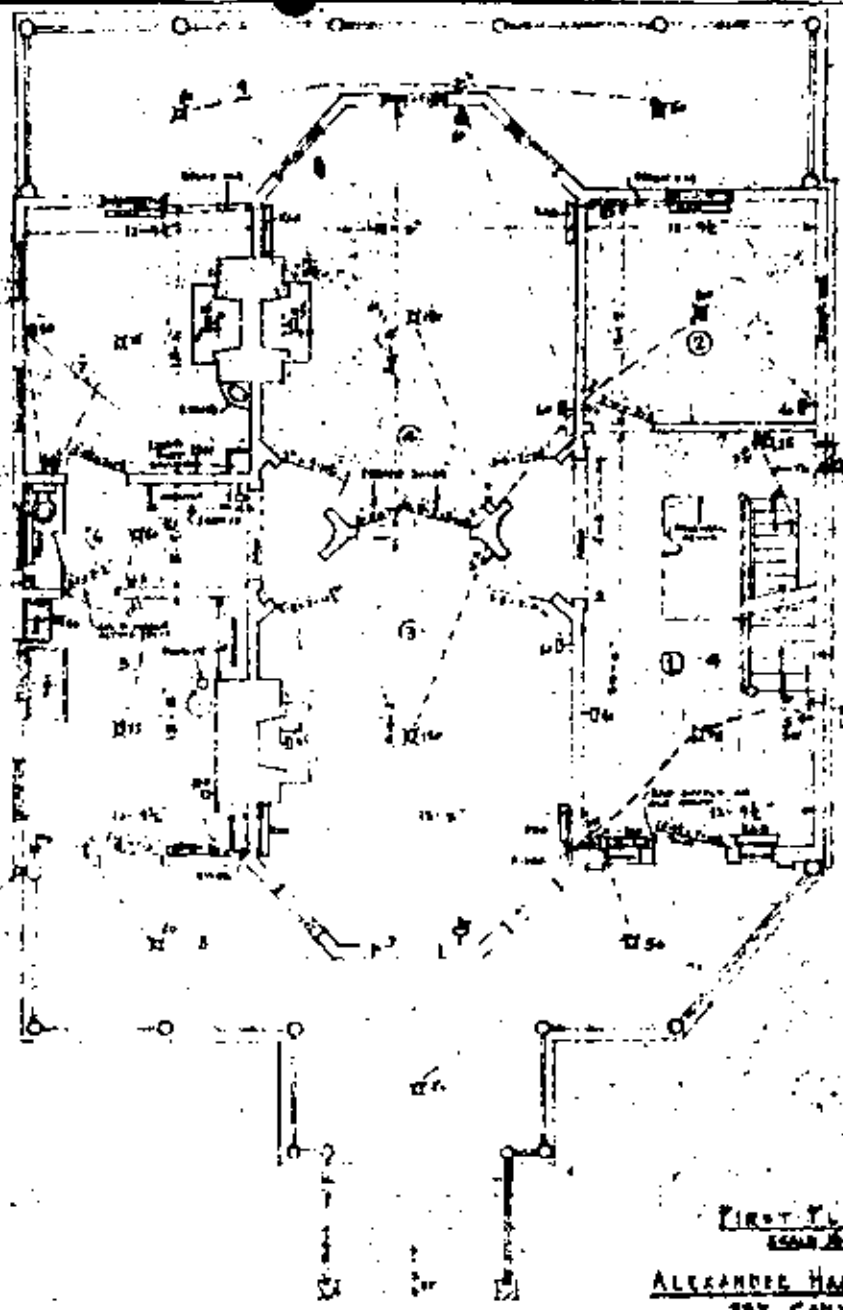

FIRST FLOOR PLAN
 137 CONVENT AVENUE
ALEXANDER HAMILTON GRAND
 137 CONVENT AVENUE
 NEW YORK CITY



Illustration 75. The Grange: West Elevation
After 1933 Painting.

Alexander Hamilton Takes a Walk



Eagle Staff Photo

Alexander Hamilton, venerable gentleman who has grown green with age while standing since 1892 in front of the old Hamilton Club on Remsen St., was uprooted from his old stamping ground today. He was shunted aboard a truck and zoomed off for Manhattan, where he will grace the Hamilton Grange, Washington Heights.

Illustration 76. Partridge Statue of Alexander Hamilton Being Removed from Original Location (1936).



Illustration 77. Partridge Statue of Alexander Hamilton
Relocated in Front of the Grange (1955).

Should none of these three possibilities prove possible, there is a fourth possible choice — a site on the present property somewhat enlarged.

If the apartment, or the two apartments, just north of the present site could be obtained and razed, an additional 100' frontage on Convent Avenue would be freed. Then the Grange could be moved say fifty feet north of its present position, to permit enough open space between it and the church, on the south, and the next property on the north. A minimum of planting could be designed to emphasize this separation.

If neither of the two ideal sites can be obtained, and if no sympathetic guarantees from CCNY are given, this is the solution that seems best to me. That area would benefit tremendously from the continued existence of this historical or cultural center; and with the house free-standing, furnished, and restored, a vivid and beautiful museum would result. [12]

NOTES

1. AS&HPS, "Hamilton Grange," Sixth Annual Report (1901), pp. 25-26.
2. AS&HPS, Sixteenth Annual Report (1912), pp. 147-154.
3. AS&HPS files.
4. Ibid.
5. Ibid.
6. Joseph T. Mulligan, letter to the editor, New York Times, Oct. 29, 1923.
7. Raymond H. Torrey, "Hamilton Grange," S&HA, III, No. 3 (Apr. 1934), p.
21.
8. Ibid.
9. "Hamilton Grange Re-Roofed," S&HA, I, No. 5 (Sept. 1929), p. 39.
10. Andrew Drakert to George F. Kunz, Mar. 22, 1929.
11. See New York Times, June 20, 1933, and S&HA, III, No. 3 (Apr. 1934), p. 5.
12. AS&HPS files.

ARCHITECTURAL DATA SECTION

Anne Derry Whidden
Architectural Conservator
Manhattan Sites

1977

I. INTRODUCTION

A. Geographical Summary

Hamilton Grange National Memorial is located on the northern end of Manhattan Island, on the east side of Convent Avenue just north of 141st Street. It sits a few blocks north of the City College of New York, and three blocks east of the Hudson River. This location -- although within the boundaries of the old Hamilton estate -- is not the original one. The Grange initially sat several hundred feet to the northwest, on a hill that commanded a view of both the Hudson and the Harlem Rivers. It was moved downhill to its present site in 1889, to serve as a temporary chapel for St. Luke's Episcopal Church, which was constructed over the next few years adjacent to the relocated Grange.

B. Historical Summary

In August 1800, Alexander Hamilton acquired a roughly triangular parcel of land in northern Manhattan — an area lying between what is now 140th and 145th Streets, and between Broadway (then the Bloomingdale Road) and Edgecombe Avenue (now located near the Old Kingsbridge Road, which marked the eastern boundary of Hamilton's property). Construction of the house began late in the autumn of 1801. The house was sufficiently complete by August 1802 to allow the family to move in, and construction was finished by February of 1803.

The architect for the Grange was John McComb, Jr., architect for many of New York's most prominent and conservative families,[1] and later designer of New York's City Hall. Son of a carpenter-builder and trained as a carpenter himself, McComb was familiar with contemporary European and American trends at the time he designed the Grange.[2] The plan of the Grange, with its octagonal rooms and pentagonal halls, reflects the influence of the Adam style on McComb's architectural designs. Furthermore, the plan of the Grange reveals McComb's ability to "borrow" a plan from a contemporary architectural book and adapt it to suit the needs of his clients.[3]

The contractor for the house was Ezra Weeks. A prosperous builder and occasional developer, Weeks was responsible for the construction of many important buildings of early New York, including several designed by McComb. Weeks apparently excavated and laid up the original foundations for the Grange and completed the rough framing, while McComb's job evidently entailed the preparation of plans and supervision of the finish work of the house.[4]

Hamilton was killed in July 1804, and under the terms of his will, the disposition of his estate was left to three trustees. These and more than 100 other friends of Hamilton formed a consortium, which purchased the property and conveyed it to his widow. She sold it in 1833. From 1833 to 1889, the Grange was owned by a succession of persons, but it continued as a single-family residence. See the Historical Data Section for more information about this period.

In 1889, threatened with demolition, the Grange was given to St. Luke's Church. The house was lifted off its foundations and moved 100 yards southeast to a new foundation on its present site. The original foundation and the cellar, which contained the kitchen, were destroyed. The only record of the plan of this lost floor is a sketch (Ill. 15) filed with the New York City Department of Buildings prior to the move.

In a 1934 article for Scenic and Historic America, Raymond H. Torrey described the changes that resulted from placing the Grange on its new site. He stated:

"...in 1889 the Grange was moved about 500 feet southeast to its present location, on one of the lots then acquired by the parish, north of the present church.

Unfortunately for the exact preservation of the Grange, as constructed by Hamilton, the two lots on which it was placed, with a width of about fifty feet and depth of sixty feet, did not offer an area, with the church then planned on the three lots

to the south of a shape and size sufficient to place the original front toward Convent Avenue or to preserve the front and back porches. The building was turned around sideways, with its old front facing towards the church, and its back to the north at the line of other property, then vacant, but in recent years developed as an apartment house. It thus became necessary to cut off both front and back porches.

In order to make the building suitable as a temporary chapel, the church also moved the large front door with its leaded panes of glass from the south (formerly front) side, around to the southwest corner facing Convent Avenue, and closed up the old door opening with a blank wall. This also entailed changes in the front hall and the stairway from the first and second stories. What had been one of the small rooms on either side of the front, pentagonal hall, described in Carter's book of 1854, was thrown into the hall, making it larger than before and the stairs were altered to suit the necessities of the church. This left the piazzas, which had formerly been on the sides of the Grange, on the front and back. A new flight of steps, from the piazza now in front to a walk to the street was added and wooden pillars [i.e., the south portico] placed at the top of these steps. [5]

St. Luke's sold the Grange to the American Scenic and Historic Preservation Society in 1924. At first, the society kept the building neatly, but its continual effort to relocate the house on a more auspicious site diverted attention from maintenance of the property. The house underwent a major restoration in 1933, and was renovated again in 1939, but in the next 15 to 20 years lapsed into poor condition. [6]

The National Park Service acquired the Grange in 1962, with the intention of relocating and restoring it. In 1970, the Park Service had the house painted inside and out, in colors based largely upon a paint analysis conducted in 1968 by Norman M. Souder, a NPS architect in the Eastern Office of Design and Construction. [7] (See Chapter IV.) The building was stabilized at this time, and water-damaged areas were repaired, but no major restoration was undertaken. [8]

C. Architectural Summary

The Grange consists of a two-story main block, with one-story piazzas extending the full width of the front, west elevation and the rear, east elevation. An entry portico is centered on the west piazza. The main block rests upon a high basement, and is covered with a ridge-hipped roof. Its four interior chimneys are positioned symmetrically on the west and east roof slopes. The piazzas and portico feature shed roofs of slight pitch.

Original Appearance

As built, the Grange faced west-southwest (Ill. 25). The piazzas abutted its northwest and southeast, side elevations, and two entry porticos graced the main, southeast elevation and the rear, northeast elevation. The move of 1888-1889 left the Grange oriented more squarely. The southwest, main elevation became the south elevation; the old northwest and southeast piazzas became the west and east piazzas, respectively; and the former northeast, rear elevation became today's north elevation. The original southwest, main-entry portico was moved to the west piazza, where it is now; the smaller, northeast, rear-entry portico was lost.

Design

Built in 1801-1802 by one of New York City's leading architects, the Grange must be evaluated in comparison to other important Federal-style architecture for its architectural merits and weaknesses to be appreciated. The leading practitioners of the Federal style were Charles Bulfinch in Boston, Samuel McIntire in Salem, and, to a lesser extent, Asher Benjamin in the Connecticut River Valley of Massachusetts. Their work, much of it still extant, provides a good index against which to evaluate the quality of McComb's design for the Grange.

The exterior of the Grange and the organization of its plan show the efforts of a highly competent master-builder, although neither element has the stylistic brilliance evident in the work of Bulfinch and McIntire. The scale and design of the Grange have more in common with the work of the well-known but more provincial builder Benjamin, and with the work of anonymous architects influenced by Benjamin's pattern books.

The five-bay, three-story buildings with low-pitched roofs, few exterior projecting elements, and small, delicate porticos built by Bulfinch and McIntire define the American Federal style of architecture. Compared to the work of these two men, McComb's design for the Grange seems squat and somewhat clumsy, with its three-bay, two-story main facade, large entry portico, and piazzas. Yet McComb's design included various architectural elements to offset the Grange's block-like proportions. For example, the attenuated proportions of the porticos' columns gave added vertical emphasis to the facade. While the Grange did not achieve the elegance of Bulfinch's and McIntire's work, it did have a good deal in common with smaller houses built in the same period. Several houses in western Massachusetts, Vermont, and Maine exhibit similar stylistic elements.

The design of the Grange, it might be noted, seems to have been an unusual one for McComb himself. Elevation drawings for larger houses that he designed show town and country houses with facades either: a) more typical of Federal-style architecture (such as that for Rufus King in 1794); or b) in a more traditional, heavier, almost Georgian style (such as that for Dominick Lynch in 1797). Only two unidentified residences — also two-story, three-bay houses (Pl. 10) — have designs similar to that of the Grange.

In its plan, the Grange exhibits a traditional symmetrical arrangement of rooms, although the two octagonal rooms and pentagonal halls with polygonal apses on the first floor indicate McComb's awareness of the new, British, Adam style, which embodied freer organization and delight in circular and elliptical shapes.

The interior moldings, mantels, and woodwork found in the Grange display the same architectural qualities as does the exterior. While they do not exhibit the sheer technical virtuosity apparent in the interior detailing of buildings by master woodworker Samuel McIntire, they are handsome and surprisingly varied.

The Grange is the only remaining example of John McComb's domestic architecture that has not been altered seriously.[9] As such, it deserves to be sensitively preserved and restored.

Condition

The Grange retains most of the features of its original design, but its architectural quality is compromised by its present location. With the original front elevation facing the side wall of the adjacent church, important aspects of McComb's design are lost. The entry, as constructed, was much more important to the formal design of the elevation than it is today. The front door was in the center of the today's south wall, directly below the still-extant triple window at the second-floor level. The leaded sidelights of the door were identical to those of the triple window above, and all were aligned to form a unified, full-height composition. Today, of course, the door and window are not aligned, and the sidelights of the front door were vandalized several years ago.

A more subtle, but equally important, architectural detail was the use of clapboards versus flush-board siding. As in many houses of this period, flush boarding was used on the front elevation of the house to give the main entrance a smooth, elegant appearance suggestive of stone. Flush boarding also was used at the Grange on the first story of the side elevations, presumably because the piazzas there were to be extensions of the formal octagon rooms. Clapboard siding was used on the less-conspicuous second floors, and on the entire rear elevation. Today, because the original front elevation cannot be seen easily, the distinction between flush and clapboard siding goes unnoticed.

NOTES

1. S. Damie Stillman, "Artistry and Skill in the Architecture of John McComb, Jr.," p. 96. Included in the McComb collection at the New-York Historical Society are the drawings of houses McComb designed for Refusing, Dominick Lynch, Benjamin Moore, Francis Childs, and John B. Coles. Stillman notes that all of these men were prosperous and prominent New Yorkers, and suggests that McComb "might almost be considered the architect royal to the Federalist party."

2. Whether McComb traveled to Europe, or whether he knew of contemporary European architecture primarily through architectural publications, is a question open to further study. Stillman indicates that McComb traveled abroad, but Agnes Gilchrist, in her Society of Architectural Historians Journal article of March 1972, argues that he did not.

3. Mongin, quoting James VanDerpool, "A Restoration Problem at Hamilton Grange," Columbia Library Columns, IV, No. 2 (Feb. 1955), pp. 11-23. The volume by James Paine (discussed in VanDerpool article) from which the design for the Grange appears to have been drawn, however, was not one of the books in McComb's personal library. (See Stillman's "Artistry and Skill.")

4. McComb's bill of February 10, 1803, is simply for "finishing the dwelling house," which suggests that Weeks did the earlier work.

5. Raymond H. Torrey, "Hamilton Grange," Scenic and Historic America, III, #3, April 1934, pp. 18-20. See Mongin card file, Federal Hall, under 1934.

6. Letter from Ward Melville, chairman, Committee on Hamilton Grange, to the trustees of the American Scenic and Historic Preservation Society, April 19, 1948: "The situation of Hamilton Grange is deplorable. The building is in bad repair and needs painting."

7. His recommendations in file #14, Superintendent of Manhattan Sites files, Federal Hall.

8. See letters, especially from Newton Bevin, with regard to stabilization of building, files #1 and 2, Superintendent of Manhattan Sites files, Federal Hall.

9. McComb drawings, New-York Historical Society; see especially drawings #107 and 99b. Several other McComb buildings are extant, but one has been entirely gutted, and two others -- at 27 and 27a Harrison Street -- were moved in 1969 and have been partially "restored."

II. EXISTING CONDITIONS: EXTERIOR

A. Introduction

As mentioned earlier, the Grange underwent repairs and a complete repainting in 1970. It continued to deteriorate, however, and by 1976, extensive work was required. Therefore, funding was provided for the preparation of the Architectural Data Section of the Grange's Historic Structure Report in 1977, and for exterior stabilization. The stabilization was envisioned as "Phase I" of a two-stage plan. "Phase II" would consist of the moving of the Grange to a more spacious site, and its complete restoration at that time.

Phase I was conducted during the winter of 1978-1979. Excluded from the work campaign were items that could not be reintroduced to the Grange in its present, cramped location. Original material was retained and conserved as much as possible. However, more new material than originally anticipated was needed to replace unsalvageable or missing elements. Replacement pieces were, in most cases, exact copies of original material. All new wood was pressure-treated with the wood preservative Osiose. Concerning areas of original rough (as opposed to finish) carpentry, standard lumber was used in concealed areas, but rough-sawn lumber was used wherever it would be visible. See Appendix K for more information.

* * *

This Architectural Data Section, although drafted in 1977, has been edited to reflect the Phase I activity that took place in 1978-1979, as well as the limited amount of work that has been done concerning Phase II.

B. Roofs and Balustrades

Main Roof

Framing. The primary members of the roof structure are typical of ridge-hipped construction: four hip rafters rise to two posts that are connected by a short horizontal beam forming the ridge. However, the Grange's hip rafters do not ascend continuously from plate to post. Each "rafter" consists of two sections. The lower section rises from the plate to the corner of a rectangular frame made of heavy (seven- to nine-inch) horizontal beams; the upper section rises from this corner to the top of one of the ridge posts. The rectangular frame is supported at each of its corners on a shorter (five-foot) post, which rest in turn upon two timbers running north-south at attic floor level, just inside the chimney stacks. See Chapter III, Section E, for more data.

There are two rafter systems. Those ascending from the plates to the hip rafters and the intermediate timbers are more closely and uniformly spaced, while those rising from the intermediate timbers to the hip rafters and ridge beam are more erratically spaced. The inch-thick sheathing boards appear to be as old as their rafters.

The variation in rafter placement suggests that the lower and upper sections of roof may not be contemporaneous, and other evidence indicates this as well. Three of the four intermediate timbers -- all but the south one -- are incised with mortise holes that contain the ends of trunnels and, in one case, a six-inch, wrought-iron spike. Moreover, those holes in the east and west timbers are aligned. This suggests that beams originally spanned the distance between the horizontal timbers, carrying a flat roof deck. (The absence of mortise holes in the south horizontal timber may indicate that this beam was replaced.) Thus, the lower part of the present roof framing is original, with the upper portion being later.

This evidence is consonant with architectural styles prevalent when the Grange was built. The use of a deck atop a hipped roof, in an attempt to minimize the visibility of the roof, had begun as early as 1728; it was very common in important houses after 1750. [1]

The pattern of nails in the attic bears out the hypothesis that the roof was raised. The oldest nails found on the lower section of the hipped roof are cut nails with hand-made heads. This type was used as early as 1790, well before the date of the Grange's construction. The oldest nails in the upper section of the roof, by contrast, are cut nails with sheared points, available only after 1830. The number of nail groups found in the upper and lower hips suggests that the raising had taken place by the time of the second shingling. It is thus likely that the roof was raised and reshingled c. 1835, the year Isaac G. Pearson purchased the Grange.

The reason behind the roof being raised to its present configuration is not documented. However, judging by the history of the piazza roofs, it would seem most probable that the flat deck could not be made watertight. (Perhaps water damage was the reason for the replacement of the south horizontal timber.)

Covering and Flashing. The Grange has had several documented reroofings. The present main roof is a standing-seam hipped roof of 16-ounce sheet copper that was applied in 1929 and repaired in 1978-1979. The predecessor of this material was tin-coated iron, or tinsplate, installed by St. Luke's Church in 1894. Portions of this metal remain under the copper, and plasma gas analysis of samples taken from the north and south roof slopes revealed its identity.[2] Traces of zinc-coated iron (a galvanized material) also were found on the north slope, above the tinsplate roof.[3] This metal seems to have been used for patching purposes.

A still earlier covering was wooden shingles; these appear in Illustrations 49 and 58. There is no documentary record of the original roofing material. However, the nail pattern visible in the attic suggests that the material of the lower part of the original roof was wooden shingles. The hand-headed cut nails used in this area are approximately two inches in length, spaced in rows approximately four and one-quarter inches apart. The length of the nails and this spacing would have been appropriate for short wooden shingles about 18 inches long.[4] The pitch of 5:12 also would be appropriate for wood. A newspaper item advocating the use of tile roofs noted, "Our roofs...consists for the most part of cedar..."[5] Cedar shingles were readily available from New Jersey during the period in which the Grange was built.[6] Furthermore, nail evidence for approximately five shinglings would indicate that a less-permanent material than slate was used on the lower portion of the main roof.

The flashing of the main roof was probably solid lead. A strip of this was found in 1977-1978 at the junction of an original roof and the main house. (See "Piazza and Portico Roofs, Framing.") And architect Newton Bevin wrote to National Park Service Chief Historical Architect Henry Judd in June 1968, mentioning that he, too, found original lead flashing, although he does not indicate the location.[7]

The original flat deck atop the main roof would not have had the pitch required for shingles. It probably would have been covered with red-painted tinsplate (see "Piazza and Portico Roofs, Covering and Flashing") and flashed with lead, with flat seams because of the exceedingly low pitch. Further evidence may be found when more work is done on the main roof.

Piazza and Portico Roofs

Framing. The slightly pitched shed roofs of the piazzas today are products of the work of 1978-1979. It is thought that they replicate the appearance of their historic counterparts, with one exception. The southwest corner of the west piazza — clipped off c. 1890 to make room for St. Luke's Church — was not rebuilt. Framing and sheathing are of Douglas fir; the sheathing is topped by a layer of building paper and a layer of asphalt-impregnated paper.

Before the 1978-1979 restoration campaign, the piazza roofs were moderately pitched hipped roofs. In the absence of the original plans for the building, it was assumed that this was the historic configuration. However, physical investigation of the area between the west piazza's roof and ceiling revealed that the original piazza roofs were shed-type roofs having very little slope — about 1/2:12. These apparently were rebuilt c. 1830-1850, to increase their pitch and get a hipped-roof configuration. Paint samples indicate that the earlier date is more likely.

This most likely was done to improve the roofs' performance: early repairs to the east octagon room's cornice suggests that water damage occurred here. The pitch was increased by raising the roof edge abutting the main block and lowering the edge supported by the columns. Enough slope was generated in this manner, apparently, to allow the width of the entablature to be increased from 16 to 24 inches -- thus lowering the ceiling level -- and still achieve a net increase in pitch.

Evidence for the roof raising is depicted in Illustration 78, taken when the house wall above the west piazza was opened up during the work of 1978-1979. Arrow 3 shows the later, lower joist and ceiling line. Arrow 1 points to flush-board siding that originally was exposed, but which was concealed when the ceiling was dropped. Arrow 2 indicates a paint line marking the level of the original ceiling, while Arrow 4 points to a joist pocket for that ceiling. Paint samples from the area around Arrow 7 contain red roof paint (iron oxide and red lead), which shows the level of the original roof. Arrow 6 indicates paint marks representing clapboards originally visible over the west piazza, but which were removed when the roof was raised.

The information seen in the area around Arrow 5 is more difficult to interpret. The strip of solid-lead flashing seems to relate only to the bay window, and not to the piazza roof in general. Current thinking has the flashing being installed as part of a temporary roof over the bay windows before the piazzas were built. This is supported somewhat by McComb's initial proposal of June 22, 1801, which provides only for the foundations of the piazzas, and not for the piazzas themselves.

Evidence that the outer roof edge was lowered consists of the fact that all of the columns had been shortened, on both piazzas.

The shed-roof form was inferred from the fact that the roof-paint line at the end of the house was at the same level as at the center of the house. The theory that the roof was raised is supported by all four pieces of evidence. The historic pitch of the roof was plotted as follows: a piece of what is believed to be the original piazza entablature was found in situ, although it had been made wider with later material. The original column height was also discernible, and this -- added to the 16-inch width of the entablature -- gave the height of the outer edge. The slope between this and the line of paint could then be determined. This calculation produced a slope of about 1/2:12.

It is possible that the piazza roofs' pitch was increased at the same time the main roof was raised. If so, this would suggest an earlier, rather than later, date for the piazza-roof work. The year 1835 seems a likely time, when Isaac G. Pearson purchased the property.

The present framing of the hipped portico roof is of the same material as the piazza roofs' framing, because it, too, dates from 1978-1979. Its pitch is not historic, however. It was determined by the desire to have a harmonious junction between the historically correct west-piazza roof and that of the portico, which was moved here in 1889. Examination in 1979 of the sheathing of the south elevation -- where the portico originally sat -- revealed the scars of two roofs (Ill. 79). The upper, hipped one seemed to have been the product of a post-historic roof-raising: it had intersected the enframing of the tripartite window in an awkward way, and its flashing had been badly done. The lower roof was recalled by a line of red roof paint and two parallel lines of joist pockets, indicating the rafter and ceiling levels,

respectively. It must have been a very slightly pitched shed roof, and so was deemed to be the original one, with the higher roof being attributed to the general roof raising of c. 1835. (The same probably applies to the missing north portico's roof, although the physical evidence is less clear.) The slope of the portico's roof may have had to be altered again when the portico was moved to the west elevation in 1889. Twentieth-century efforts to remedy the formation of ice dams here also may have contributed to the portico-roof pitch extant in 1978.

Covering and Flashing. The present covering of the piazza and portico roofs consists of pans of terne-coated stainless steel put on in 1978-1979. This replaced sheet copper laid in 1929. The pans measure 14 by 20 inches long. They are laid lengthwise, with cross joints being staggered; the flat seams are welded. Flashing is also of terne-coated stainless steel. The roofs are protected by coats of red Tin-o-lin paint. (See Chapter IV.)

The low pitch of the original piazza and portico roofs would have required some type of sheet-metal covering, as would have the flat deck on the main roof. The line of red roof paint (red lead and iron oxide) found where the original west-piazza roof abutted the main house indicates that the metal was a type that needed to be protected by paint. The only such metal available at the time the Grange was built was tinsplate. Therefore, the original piazza- and portico-roof covering was most likely red-painted tinsplate pans. These normally would have measured about 10 by 13 inches, and been joined with white-lead caulk if the seams were flat. Standing seams are less probable, because of the exceedingly flat slope of the roofs.

Ceilings. The beaded-board ceilings of both piazzas and the portico are 1978-1979 replicas of the historic ones. The boards consist of singly beaded pieces of Douglas fir measuring three-quarters of an inch thick and between five and three-quarters and seven and one-half inches wide.

The evidence for the reconstruction of these ceilings was found during the 1977-1978 investigation into the area under the west-piazza roof. The narrow-matched-board ceiling extant at that time was determined to have been installed in the late 19th century. Above this, however, were timbers with pockets cut out for joists no longer there. These joists probably supported the original ceiling; paint outlines on the body of the house revealed the dimensions of the original boards, which were actually a full inch in thickness.

This original ceiling had to be rebuilt when the roof pitch was increased c. 1830-1850. The lower, replacement ceiling was of wooden lath and plaster; the indications of circular-sawn lath and cut nails used in this ceiling is the main way in which the 1830-1850 date was obtained for the roof raising. This ceiling in turn was supplanted by the narrow-matched-board ceiling, probably at the time of the move.

Balustrades

There are no balustrades upon any of the Grange's roofs today. Early photographs (ills. 33-35, etc.) show identical balustrades in eaves position on the main, piazza, and portico roofs. Concerning the dimensions of these balustrades, a

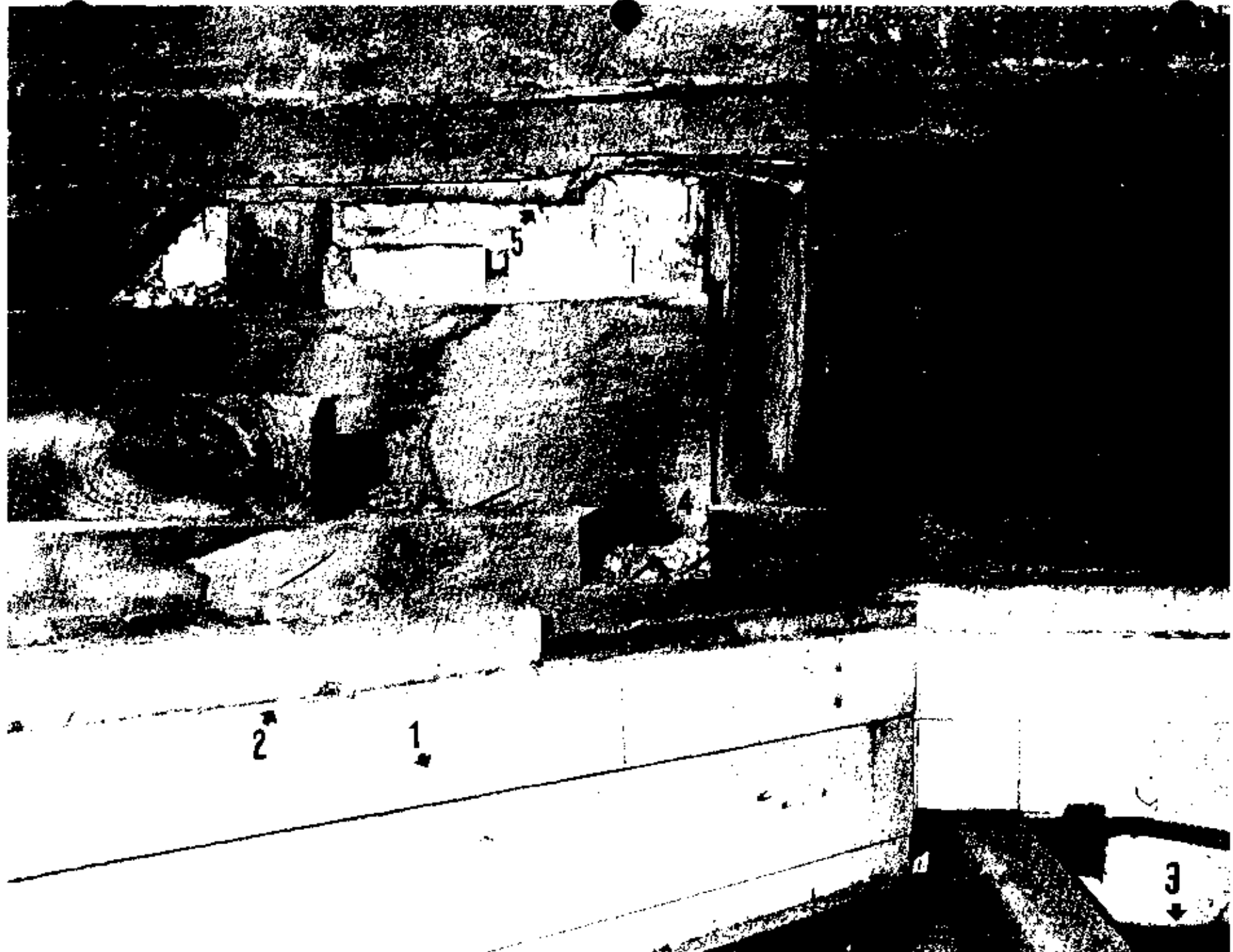

Illustration 78. The Grange: Evidence of Original Piazza Roof (1978-1979).



Illustration 79. The Grange: Evidence of Original Portico Roof (1979).

1964 report on the Grange by architect Newton Bevin suggests that Wakefield Worcester of the Architects' Emergency Committee based his full-scale, 1933 drawings of the balustrades on first-hand examination.

These balustrades were removed in 1929 because of deterioration, and were burned for firewood in 1933-1934.[8] Unfortunately, their construction was not documented, and their originality to the house is questionable. Documentary evidence is nonexistent. Stylistically, the concept of the main-roof eaves balustrade was well established by the time the Grange was built.[9] The same holds true for the balustraded entry portico.[10] The use of piazzas was prevalent in New York even before the Revolution.[11] Few of McComb's other designs show the use of balustrades, but in at least one case where a balustrade is indicated, its form is very similar to that shown in the early photographs of the Grange.

On the other hand, the physical evidence argues against the originality of the eaves balustrades seen in the photographs. During the 1978-1979 work, the outer edge of the main roof was opened up, and there was no indication of any original anchoring system. Such a system would have been particularly necessary to secure a balustrade to a wood-shingle roof, which the Grange originally had. No marks of any roof-deck balustrade were found on the chimneys.

As for the piazzas, the shed-type form of their original roofs would have been very difficult to balustrade properly. It would have been more logical for the piazza balustrades to have been introduced when the roofs were converted to the hipped form c. 1830-1850. Furthermore, the sheathing of the upper west elevation was examined in 1978-1979. The scars where the piazza's hipped-roof balustrade was attached were found. However, there were no marks where a shed-roof balustrade would have attached.

Concerning the porticos, when the south-elevation sheathing was examined in 1978-1979 (Ill. 79), the ghost of a balustrade was found in conjunction with the hipped-roof line thought to be posthistoric. Presumably, this would have been left by the balustrade put on c. 1830-1850, and seen in the photographs. There was no balustrade ghost found in conjunction with the shed-roof line deemed to be historic.

C. Chimneys

Operative Stacks

Of the Grange's four interior chimneys, only the two northern chimneys are functional. Both are constructed of red, water-pressed bricks that measure approximately seven and three-quarter inches long by three and three-quarter inches wide by two inches thick. Each stack was partially rebuilt in 1978-1979, using original and replica bricks. The northwest stack was 50 percent redone, while the northeast stack was 75 percent redone. The present flue-liner tiles date from the early 20th century; these were retained during the work of 1978-1979. Both stacks are flashed and capped with terne-coated stainless steel applied in 1978-1979, with an opening having been provided for the boiler flue. Prior to the rebuilding, layered traces of red and white paint were present on the north sides of both stacks.

McComb's proposal of 1802 mentions the building of two stacks of chimneys, and it seems evident that these correspond to the ones extant today. The framing around the stacks in the attic contains wooden trunnels and wrought-iron nails; it appears to be both original to the house and unaltered. Thus, the chimneys themselves can be assumed to be in their original positions.

Inoperative Stacks

The two southern, false chimneys consist of framing, sheathing, and board cladding assembled with hand-wrought nails. They are presently covered with the same soldered, red-painted, terne-coated, stainless-steel pans used on the piazza roofs in 1978-1979. This metal replaced tinfoil cladding that was applied in the late 19th century: it was attached with small cut nails characteristic of this period, and may have dated from the reroofing of 1894. The stacks are now capped and flashed with terne-coated stainless steel, also introduced in 1978-1979.

McComb's proposal of 1802 mentions nothing of the two false chimneys, but other documentary and physical evidence indicates that they were original to the house. They appear in the earliest photographs of the building, and the wrought nails confirm a c.-1802 date.

D. Entablatures and Gutter Systems

Entablatures

Main Block. For the Grange proper, McComb chose to use a Doric entablature, with triglyphs, plain metopes, taenia, and guttae at the frieze, and simplified mutule blocks (without guttae) under the soffit. Neither McComb nor other leading Federal-style architects made frequent use of the full Doric order. McComb's drawings for town houses and other country houses more frequently show mutule blocks combined with simple, unornamented friezes, or else with a denticulate frieze. Bulfinch used it on the porticos or entries of churches (in Pittsfield, Boston, and Lancaster, Massachusetts), but not on his domestic architecture. McIntire used the Doric order only on the entry porches of the 1782 Peirce-Nichols house in Salem, Massachusetts. Both men seem to have considered the Doric order too heavy visually for extensive use on Federal-style houses.

The present appearance of the main entablature dates to 1978-1979, when the deteriorated and crudely patched original entablature was taken down, conserved, repaired, and reinstalled. During the work, it was discovered that the pieces of the original cornice had been fastened with wrought sprigs. The remaining pieces of original entablature were conserved and reinstalled, with reproduction material being used for infill. Ninety percent of the original fascia board was salvageable, but 75 percent of the applied pieces had to be replaced.

Piazas and Portico. The current piazza and portico entablatures are historical reproductions that date from the restoration of 1978-1979. They consist of a 16 inch-wide, unornamented fascia board. When the porch roofs were raised c. 1830-1850, the original fascia board was widened to about 24 inches by the addition of new material. One of the original boards was found in situ in 1977-1978, and used to help compute not only the original width of the fascia, but also the original pitch of the roofs.

The extant photographs of the Grange show that two types of molding strips have ornamented the fasciae at different times. Illustration 34 shows an early one on the south portico only; Illustration 75 shows a later, higher one on the portico and west piazza. It is possible that one or the other was installed to help conceal the joint between the early, narrow fascia boards and the later, additional material.

Gutters

Main Roof. A length of original, built-in, wooden gutter still exists at the southeast corner of the main block. The remainder of the main-roof guttering is a replica of the original, with one exception: the troughs are lined with copper, for durability. In his letter of August 1800 to Hamilton, General Schuyler requested the dimensions of the timber to be used for the gutters. The form in which these were made is known, because portions of them have survived down to the present time. Newton Bevin studied these remnants for his 1964 report; he described them as being

fashioned out of solid wood about six inches by 13 inches in cross-section, with a sloped groove and resting upon a large wooden bed molding. He further noted that they were held by iron straps one inch by one-eighth inch, spaced about seven inches apart, let into the bottom of the gutter and concealed by the mutule blocks attached to the soffit, which forms the underside of the gutter. [13]

The use of built-in gutters is appropriate to this period. The Rules of Work of the Carpenters Company of the City and County of Philadelphia, published in 1786, gives prices for "common plain gutters under eaves, of scantling from three to four inches thick, and five to six inches broad..." [14] The more generous dimensions of the Grange gutter are apparently due to the use of the broad soffit. Plate XXIV of the Rules of Work includes three cornices, none of which resemble the Grange cornice. Charles E. Peterson, the editor of a recent edition of the Rulebook, notes that these may or may not have contained gutters, but his comment indicates that this was a possibility at this date. Further evidence for the historicity of the Grange gutter is the fact that McComb used built-in gutters or gutter/cornices on two houses he built on Washington Street, New York City, in 1796 and 1819. (These houses have been moved and now constitute 27 and 27a Harrison St.)

Before the work of 1978-1979, original guttering existed not only at the southeast corner, but also on the north elevation, buried under several layers of roofing material. The 1978-1979 campaign saw the north elevation gutter removed and reused as a model for the new reproduction gutter that was put upon all of the elevations. The southeast section, however, was allowed to remain in place.

Piazzas. Each piazza has a box-like gutter of terne-coated stainless steel running along its long, outer edge only (there is a short return at each end). These were installed in 1978-1979. It is unlikely, though possible, that gutters existed here originally: they were not used on the porticoes (see below), which would have needed gutters more than the piazzas, because they had stairs leading up to them. Wooden gutters were found on both piazzas in 1977-1978, but they were determined not to be original. The extensive rebuilding that occurred c. 1830-1850 obliterated most of the physical evidence. Therefore, the stainless-steel gutters were put up as a temporary measure until the question could be settled. The box shape was chosen because it could not be mistaken for a historical profile.

Portico. The same types of gutters used on the piazzas are found on the portico, for the same reasons. The investigation of the south-elevation sheathing in 1978-1979 (Ill. 79) showed that the hipped roof had a wooden gutter, of about the same form as the length of gutter taken off of the west piazza and stored in the subbasement. However, this roof is thought to have been posthistoric. No evidence of a gutter was found in conjunction with the historic shed roof. Therefore, it seems that there were no gutters on the portico originally.

Leaders (Downspouts)

Most of today's leaders are of copper, installed during 1978-1979. These replaced galvanized-steel leaders, some of which were retained. The material of the original leaders was lead, based upon investigation of the main-roof gutter in 1978-

1979. Advertisements from contemporary newspapers show that leaders of either lead or tinned copper would have been available in 1802. In 1783, a partnership advertised as "Emery and Newman, from London Plumbers, and Glaziers" announced "their sale of (Lead) wall pipes with elegant ornamented cistern heads." [15] In 1793, a New York newspaper carried the advertisement of a British manufacturer for copper pipes "coated with a metallic composition, which prevents the corrosion of the copper, and which are sold under the title of Tinned Copper...Pipes." The compiler of these advertisements notes that the copper pipes were billed as a cheap substitute for lead. [16]

A complete system of gutters is seen in Illustrations 34 and 35, dating before 1876. These photographs show metal leaders positioned at each corner of the roof, and on the piazzas and front portico. These leaders appear to have long, gently curving elbows — the hallmark of continuous, shaped lead piping. (Tin and copper would not have been shaped, but rather cut and soldered, forming angular elbows.) The placement of the gutters and leaders, however, seems to date from the work of c. 1835, rather than 1802-1804.

One further observation should be made about the Grange downspouts. Illustration 35 shows a pipe slanting across the original rear, northeast elevation of the house into what appears to be a vertical wooden casing, next to the leader on the north corner. This pipe seems to emerge from the house below the centermost window on the second floor — the precise location of the first bathroom. Although the pipe does not appear to be large enough to be a sewer or waste pipe, the fact that part of it is enclosed — whereas the leaders are not — indicates a particular interest in not having it freeze. (The casing even may have been packed with sawdust.) The date of this photograph — before 1876 — thus might represent a tentative date for the bathroom.

E. Siding and Trim

Flush Boards

The flush siding used on the south elevation consists of splined boards three-quarters of an inch thick and approximately four and one-half to five and one-half inches wide. About half of them are the original cladding boards; the rest are reproduction boards installed in 1978-1979. During this work campaign, about 75 percent of the original boards were removed, chiefly around the former location of the front entrance. (The sheathing also was removed in this area, and the cavity filled with six inch-thick fiberglass insulation.) Those boards more than 50 percent deteriorated were replaced with replicas made of Alaskan yellow cedar. The rest were conserved before being reinstalled. Cracks were glued, spaces filled with lead or epoxy, and everything soaked in boiled linseed oil. The boards not removed were conserved in situ. All in all, nearly all of the boards in the former door vicinity are new, while most of the boards elsewhere are conserved originals.

The boards of the flush siding on the lower east and west elevations also are splined, but measure 12 inches wide. These are all original: having fared better over the years because of the protection afforded them by the piazzas, none had to be replaced with replica boards in 1978-1979.

Undisturbed original boards are held with wrought nails having handmade heads of flattened "T" shape. Original and new boards attached in 1978-1979 are secured with reproduction wrought nails having rose heads.

Clapboards

The clapboard siding on the north elevation, and on the upper east and west elevations, consists of butt-jointed sawn boards four and one-half to five and one-half inches wide, with a weather of three and one-half to three and three-quarters inches. Their length varies considerably: the longest measures about 11 and one-half feet, while the shortest is about four feet. These boards are not tapered in the usual manner. Their top edge measures five-eighths of an inch wide. The board thickens to seven-eighths of an inch about one and one-half inches from its bottom edge, where a rabbet reduces its thickness back to five-eighths of an inch. This rabbet fits snugly over the clapboard beneath it (see below).



not to
scale

About 75 percent of the clapboards on the north elevation are the original sawn, hand-planed, pine boards. These were conserved in situ in 1978-1979, in the same manner as the flush boards were. The remaining boards — clustered in the former vicinity of the rear door — are replica clapboards of Alaskan yellow cedar. These were installed during the work of 1978-1979, along with all of the clapboards currently on the upper east and west elevations.

The nail types used for the clapboards are the same as those used for the flush-board siding.

Trim Boards

The unornamented corner boards measure approximately half an inch thick by eight inches wide. Judging by the wrought nails used to fasten them, most of these are original. Those at the southeast corner were replaced in 1978-1979, along with portions of the corner post in that area.

Sill boards exist on the north and south elevations only. About 50 percent of the material constituting these boards dates from 1978-1979 — the southwest, southeast, and northeast corner portions in particular. The top surfaces of all sill boards are flashed with terne-coated stainless steel, installed in 1978-1979.

Sheathing

Most of the current sheathing consists of vertically sawn boards about three-quarters of an inch thick by about one foot wide. Edges are roughly finished and indistinct. The siding boards cover this sheathing, but are nailed through it to the studs. This material appears to be original, judging by the saw marks and the old, rose-headed wrought nails used to attach it.

Three areas do not have undisturbed original sheathing. The south-elevation sheathing in the former vicinity of the front door is original, but it is salvaged material moved from the upper east elevation in 1978-1979. It replaced c.-1889 sheathing that was introduced when the door was closed up. The north-elevation sheathing in the former vicinity of the rear door still dates from c.-1889, having been left untouched during the 1978-1979 work. The original sheathing below and between the four windows on the upper east elevation was moved to the south elevation in 1978-1979, as already mentioned. This was replaced by sheets of plywood installed for structural reasons, as described in Chapter III, Section A, "Framing."

F. Foundation

The present rubblestone foundation walls date from the move of 1888-1889, which required that the old foundation walls be demolished. The west and east foundation walls at basement level are coated with an ashlar-scribed, concrete parget applied in 1978-1979. The north and south basement walls are not pargeted, and they need to be repaired.

The original Grange foundation probably consisted of dressed sandstone (brownstone), pargeted and penciled with a light color to resemble coursed ashlar masonry blocks approximately eight to nine inches high by 12 to 18 inches long. Sandstone is postulated for two reasons: it was used for the foundations of contemporary houses in the area, and pieces of it are found throughout the present foundation system. Similar stone was being used across the Hudson River in upper New Jersey. It was used for the original foundation of Boscobel, built in Westchester County the same year as the Grange. Too, pieces of dressed sandstone are scattered throughout the present foundation walls, and blocks of it are used under the square wooden posts that support the west piazza. Since the blocks resemble those seen below both piazzas' posts in photographs taken before the move, it is thought that they were salvaged from the original site and reused beneath the west piazza's posts.

The presence of pargeting has been deduced from McComb's "Final Account" of May 23, 1803, to Hamilton, which includes an entry of \$13 for "Rough casting the foundation." Illustration 34 shows such a coating, and Illustration 38 reveals that the coating was old enough to be deteriorating by c. 1888. This type of finish, of course, would have been consistent with Federal architectural practices.

The penciling is seen in all of the early photographs. It cannot have been scribing, because of its light color; scribing would have produced shadows, i.e., a dark color.

G. Porches

Piazzas

Columns. Each piazza roof is carried on eight Roman Doric columns, which exhibit a slight entasis. The columns at each inside corner are engaged against the house wall. The necks of the columns measure two and one-half feet in diameter. Their capitals feature several annulets between the quarter-round echinus and the column necking, and their bases are correct Doric forms. All columns are capped with terne-coated stainless steel.

The present engaged columns are original elements repaired in 1978-1979. All of the freestanding columns are nearly exact, 1978-1979 copies of the original ones. They differ from the old, solid ones only in that they are hollow and made of California redwood, for durability. The correct form for the columns' components was determined during a study of all columns extant in 1977-1978, which found 10 original columns remaining, in various states of alteration. (Bases and capitals had been changed, and overall heights reduced.) The least altered column was kept as a record and stored in the subbasement of the Grange.

There is also a range of posts along the east side of the Grange, below the east piazza's colonnade. Because the present site of the Grange slopes steeply from west to east, the east elevation today is not two but four stories high (Ill. 70). Below the original east piazza is another piazza-like gallery, fronting the east wall of the basement; the outer edge of this gallery rests upon a rubblestone wall corresponding to the height of the present subbasement. Neither the lower gallery nor the rubblestone wall existed at the original, more level site; the east piazza rested upon wooden posts like those under the west piazza. Today, the lower gallery features square posts of Idaho white pine installed in 1978-1979, which are connected by sections of the redwood reproduction balustrade used on the piazzas. These posts were made to have the same dimensions as the reproduction columns of the east piazza above, for compatibility's sake. They replaced turned columns that — according to early photographs — appeared to have dated from 1888-1889.

Balustrades. The current balustrades around the piazzas' and east gallery's floors exhibit an old, and possibly original, profile. These were made in 1978-1979 of the redwood used for the columns; the form was copied from two sections of balustrade found on the west piazza that appeared they might be original. These sections were of mortised construction, although reinforced with wire nails. Their restrained handrail shape and square balusters were consonant with Federal styles. The handrail profile matched a ghost of what was thought to be the original handrail — an unpainted area upon the southeast engaged column of the west piazza. And the paint-layer sequence on the balustrade sections matched that thought to be original to the house (see Chapter IV). These sections are currently stored in the subbasement, also.

Flooring and Framing. There is a good possibility that the present flooring of the west piazza is original, despite its generally good condition and lack of numerous paint layers. The splined fir floorboards are of random width, from four to seven and one-half inches wide. Their tongues and grooves are offset toward the bottom edge —

usually indicative of a later date. However, they have vertical saw marks and a number of wrought nails imbedded in them. Too, interior floorboards known to be original also have offset tongues and grooves, although offset toward the top edge. Concerning the west piazza's floor framing, records indicate that the framing of both piazzas' floors was replaced in 1929, but at least some old joists seem to have remained.

The east piazza's floor dates from 1978-1979; its splined boards were copied from those of the west piazza, but made instead of Douglas fir. The Douglas-fir framing beneath it was installed at the same time, fashioned after the west piazza's floor framing and the few pieces of original east-piazza framing that remained. The lower, east gallery's floor was rebuilt similarly.

Portico

Columns. The two pairs of attenuated Roman Doric columns at the outer corners of the west portico are 1978-1979 replicas of the original ones. These were modeled after the only original portico column found during the study of Grange columns in 1977-1978. (Before 1977, all of the original columns upon the portico had been replaced, but one had survived as a replacement for an original west-piazza column. Today, this column is stored in the subbasement.) Like the new piazza columns, the new portico columns are hollow and made of redwood; they are capped with terne-coated stainless steel.

When the portico was in its original location on the south elevation, the pairs of freestanding columns lined up with two pairs of matching pilasters that were a part of the front-door enframingent (Ill. 44). The innermost of each pair of pilasters still exist; they were moved, along with the front door, to the south end of the west elevation in 1888-1889. Their original relationship to the columns is lost, however, because the portico no longer fronts the main entrance.

The columns of the original rear, north entry portico -- seen in early photographs -- seem to have been the same size as those on the south portico, but only a single column stood at each outside corner, and there were no corresponding pilasters flanking the rear door.

Balustrade. The current portico-floor balustrade is the same redwood reproduction material used on the piazzas. Evidence indicates that the two areas had matching balustrades historically. In 1978, two pieces of balustrade handrail that would fit along the two sides of the portico -- and nowhere else -- were found stored in the subbasement. One piece's profile was very similar to the two sections of west-piazza balustrade that were used as models for the reproduction balustrade. Therefore, it seems likely that the piazzas' and portico's balustrades were the same at an early date, possibly as early as 1802. The portico's balustrade was changed at least once, however, in 1888-1889, and probably again in 1941.

Flooring and Framing. The floor of the portico dates from 1978-1979, when Douglas-fir replicas of the west-piazza floorboards were installed here and upon the east piazza and gallery. The framing of the portico appeared to be nonhistoric but in reasonable condition, so it was strengthened and reused. It probably dates from 1941.

Stair. Most of the material of the portico stair also dates from 1978-1979. (Prior to that time, the stair had already been rebuilt at least twice.[18]) The Douglas-fir framing, southern pine treads and risers, and redwood balustrades are all 1978-1979 replicas. (The balustrades are of the same type installed on the piazzas and the portico proper.) The newels at the foot of the stair, however, were reused as found in 1978. These are not stylistically compatible with the Grange, but there was not enough evidence about the original newels to fabricate replicas. Illustration 33, the earliest photograph of the Grange, shows apparently plain newels, but magnification reveals dark areas at their necks and bases. These areas could represent shallow turnings, which would be consonant with Federal detailing. By 1876, prominently turned Victorian newels (Ill. 34) were present. These were supplanted by square posts before 1888 (Ill. 38), which in turn gave way to column-like newels during the 1888 move (Ill. 48). These newels were the predecessors of the present ones; after their removal, they were stored in the subbasement. There was some thought that these might have been cut-down original columns, but they are of hollow construction, whereas the original columns were of solid wood.

Piers

The west piazza and portico rest upon square wooden posts, which in turn rest upon sandstone (brownstone) blocks. There is a post under each of the piazza's columns, and under the outermost of each pair of the portico's columns. The east piazza rests upon the posts of the east gallery, which is supported by a rubblestone wall at subbasement level (Ill. 70). The old photographs indicate that the posts and blocks are the historic treatment. However, before it was moved, the portico had a post and block under each of its four columns. It appears that the sandstone blocks present today were salvaged from the original site and reused. The present posts probably date from 1929, when records indicate that "porch supports" were replaced. The present lattice is nonhistoric; the photographs indicate that the area under the porches was left open.

H. Windows

Surrounds

The architraves of the double-hung windows are simple and unornamented. Most of them appear to be original, based on stylistic evidence. The lower parts of the architraves of the two center windows on the second-floor east elevation were replaced sometime after 1955, because of extensive water damage and other deterioration. Illustration 70, taken in 1955, shows the original, deteriorated architraves.

The only original window sills that remain are those on the first floor of the east and west elevations. These have been protected by the piazzas. All of the other window sills are historical replicas made of Douglas fir, introduced in 1978-1979 to replace severely deteriorated material.

The tripartite window in the second-floor south elevation is one of the Grange's most distinctive features. Its leaded-glass sidelights were designed to complement the sidelights of the original front entrance, which initially sat below it. Almost all of this window's elements are the original ones. They are depicted in Appendix F, Sheet 10; Appendix G, Sheets 4 and 8; and Appendix H, Sheets 13-15.

Sash

All of the sash in the house — except that of the bay windows of the octagon rooms and the triple window on the south elevation — are double hung, with six-over-six lights. The panes of these windows measure 11 and three-quarter inches by 15 and one-half inches. The six window units in the two bay windows and the triple window are triple-hung, six-over-six-over-six. The glass in these windows is 12 and one-half inches by 16 and three-quarter inches. All sash is one and three-quarter inches thick, and the muntins are the same depth as the frames.

Most of the sash seem to be original, being of mortised and pegged construction and having thin, Federal-style muntins. (See Appendix M.) The glass in the original sash is a mixture of crown, cylinder, and modern types, representing original panes and the replacement of broken ones over the years. The majority of these sash — and the original frames that contain them — are in good condition. Nonhistoric sash are present in all four of the second-floor, east-elevation windows. These are exact 1978-1979 duplicates of the original sash. The new sash consist of premium-grade sugar pine. These reproduction elements replaced sash installed when the center architraves were repaired. Illustration 70 shows the original second-floor, east-elevation sash in extremely deteriorated condition, before they were first replaced.

Nonhistoric sash and frames also exist, of course, in the nonhistoric basement's windows. Some of the sash were replaced in 1978-1979, and these are of the same type as the others installed during that work campaign.

Double-hung windows were common in New York City buildings of the period, [19] but single-hung windows were in use as well. In 1794, Moreau de St. Mery, a French visitor to America, recorded in his diary the following observation about windows in New York City:

"The panes of the windows are badly set, and only the lower part of the windows is movable. These are what we call sliding windows, none are French [casement] windows." [20]

Presumably de St. Mery's observations, though applicable to town houses of the period, would not have described larger country houses such as the Grange. Various contemporary newspaper advertisements offer both domestic and imported glass in dimensions approximating those used on the double-hung windows at the Grange, [21] sash weights of various sizes, [22] and sash of the dimensions of those at the Grange. [23] Contemporary pattern and price books also illustrate how to make and price "window frames with proper rabbets and boxings for weights." [24] Sash cords and chains used throughout the house are replacements. All of the originals probably would have been of rope.

Hardware

All hardware on windows at the second-floor level dates to the 20th century. The windows on the first floor generally have hardware dating to the late 19th century, including the bronze window fasteners consisting of a button on the inside sash and spring hook on the outside. There does not appear to be any evidence for earlier window hardware.

I. Shutters

Types

The double-hung and triple-hung windows of the Grange do not have the same type of shutters. Those on the double-hung windows have flush, beaded panels, while those of the triple-hung windows have recessed, molded panels.

Double-Hung Windows. The flush-panel shutters exhibit the characteristic Federal form of one small panel above two equal-size panels per leaf. They also appear in all of the old photographs. They are therefore thought to be the oldest shutters, installed either during the construction of the Grange or shortly afterwards (1802-1820). There are actually two types of flush-panel shutters. One type has a solid top panel, and is found on the windows of the lower east elevation. The other has louvers in place of the top panel, and is used on the upper east and west elevations. The solid-panel ones are also a little longer than the partially louvered ones, since the first-floor windows are longer than the second-floor ones. There are a few replacement shutters mixed in with both groups. [25]

The present distribution suggests that the solid shutters were hung mainly upon first-floor windows, perhaps to provide security for the house during the winter, when it was unoccupied. This would mean that the original double-hung windows of the lower west elevation — later converted into doors — also had solid, flush-panel shutters. The partially louvered shutters, on the other hand, seem to have been hung chiefly upon the upper elevations, perhaps to get better ventilation.

The main problem with this idea is the north elevation. The early photographs indicate that both types of shutters were used on the north elevation as well. (This wall is devoid of shutters today, although 10 pairs of the proper types are stored in the cellar.) Illustration 35 gives the earliest information, with Illustration 62 providing clarification. It appears that the partially louvered shutters were used at the outer two windows of the second floor, and at the outer four windows of the first floor. The solid shutters were hung at the center three windows on the second floor, and at the center window of the first floor after it was created by closing up the former rear door. Excluding the latter, it seems probable that this arrangement represents the earliest one for the north-elevation shutters. Although the distribution makes little sense, there is a serious flaw in supposing all partially louvered shutters on the second floor and all solid shutters on the first floor. This would mean that at least one pair of partially louvered shutters was brought in from another elevation.

The south elevation is also devoid of shutters. It is reasonable to assume that the windows here received the flush-panel shutters when the other elevations did. The oldest photographs (Ils. 33-34, 38-39), however, show fully louvered shutters at second-floor windows and solid, recessed-panel shutters at first-floor windows. Fully louvered shutters came into common use in about 1830, but it is doubtful that Mrs. Hamilton would have spent money on shutter replacement. It is more probable that Isaac G. Pearson hung the louvered shutters — as part of a general remodeling that included the raising of the main and porch roofs — after he purchased the property in 1835. These shutters most likely were hung at all south-elevation windows. The solid, recessed-panel shutters seen at the first-floor windows resemble those still on the triple-hung windows, which — as explained below — are thought to postdate the fully louvered shutters. The recessed-panel shutters could have replaced louvered shutters, before the first photograph of the Grange was taken c. 1864.

Triple-Hung Windows. The shutters upon these windows seem to be longer versions (Ill. 80) of the recessed-panel shutters just mentioned. Their panel-molding profile includes a Grecian ovolo, which was used c. 1830-1880. These shutters appear in the earliest photograph, and so must have been hung prior to 1864. If they are contemporaries of the solid shutters seen in the photographs upon the lower south elevation, as seems likely, then they probably postdate the 1830's. The date c. 1845 seems a possible date for their installation: this was when members of the Ward family acquired the Grange as their summer home.

It is reasonable to assume that some form of flush-panel shutter was put upon these windows when the other flush-panel shutters were hung. The chief question is whether or not fully louvered shutters were installed here c. 1835, as was done on the south elevation. The hardware discussion that follows seems to answer this question.

Hardware

The present assortment of Grange shutter hardware includes original pieces, a number of reproduction pieces made for the 1933 restoration, and a quantity of reproduction pieces made for the 1978-1979 restoration. The oldest pieces can be distinguished by their thinner, all hand-wrought, finely detailed appearance. Most of the hinges fall into this category, and a goodly number of the shutterdogs. The 1930's pieces were made from rolled goods that had been hammered to resemble wrought iron. The 1978-1979 pieces were more accurate copies, but unfortunately, some of the pieces used as models may have been 1930's reproductions.

Hinges. The pattern of shutter hardware reinforces and clarifies the stylistic analysis of shutter types. The old, Federal-style, flush-panel shutters extant today hang on pintles and strap hinges of halved construction. The pintles are mounted on back plates; the hinges have a beveled edge and become very narrow toward their far end before terminating in a circle. There does not appear to be any earlier hinge marks below these hinges. Thus, this arrangement seems to be the earliest one, contemporaneous with both types of flush-panel shutters (1802-1820). The evidence for this is the presence of handmade, wrought screws still in many of these pintles' back plates, and the presence of hand-wrought bolts still holding many of these hinges onto the shutters. Early, blunt-pointed, machine-made screws also are found holding some of these pindle plates and hinges, probably representing repair work done before the advent of gimlet-pointed modern screws in 1846.

The hardware evidence confirms the idea that the south-elevation windows underwent two separate shutterings. The fully louvered shutters seen on the south elevation in photographs have disappeared, but several of their pintles remain. These seem to be of the hand-wrought, wood-driven type with diagonal brace below. Behind these pintles is evidence of earlier pintles with the same screw-hold pattern as the halved variety. This corroborates the idea that partially louvered and/or solid, flush-panel shutters were used originally on this elevation, but replaced c. 1835 with fully louvered ones.

The hardware evidence also indicates that the triple-hung bay windows have undergone three -- not two -- different shutterings. The current, full-length, Grecian-ovolo shutters hang on three hinges per leaf. This hardware is of the old, halved pindle-and-hinge type. However, it is not attached with handmade screws, and there is evidence of at least two earlier shutterings below it. Therefore, it seems that the present pintles and hinges were part of the first shuttering system, and were reused as part of the third, current system.

The screws that attach these hinges are blunt-pointed, machine-made screws that predate 1850, when pointed screws became prevalent. It is thus likely that the Grecian-ovolo shutters date from c. 1845, as mentioned earlier. However, the same type of screw was used for the second shuttering system, and it is also possible that the current screws were reused from this intermediate shuttering, just as the hinges were reused from the earliest system.

The second, intermediate shuttering is represented by a few painted-over pintle back plates, with five irregularly placed holes and the pintles broken off. Judging by these remnants and related hinge marks, this shuttering system had two leaves per jamb: one for the uppermost sash and one for the middle and bottom sash. This would make sense, because the triple-hung windows were used as doors: there was no other way out onto the piazzas. The topmost sash could remain shuttered, probably against the heat, while the lower two sash were left uncovered to facilitate passage in and out.

The hinges used for this two-tier system of shutters were fastened with blunt-pointed, machine-made screws, based upon the remaining screws. These screws were available early enough to be contemporaneous with the c.-1835, fully louvered shutter hanging. It therefore seems likely that the predecessors of the present, solid shutters were fully louvered shutters, installed when the same louvered shutters were put on the south elevation. However, the back plates of the remaining hinges resemble those of the halved pintle and hinge arrangement. This indicates that the wood-driven pintles used to hang the fully louvered shutters on the south elevation were eschewed in favor of the old-style hardware for the fully louvered shutters of the bay windows -- possibly because the older hardware was still being used on the shutters of the windows on either side of the bay windows.

Beneath the back plates and hinge marks of this shuttering are the screw holes of what seem to be still earlier hinges, for shutters also hung in the two-tier manner. These undoubtedly represent the earliest shuttering, which probably consisted of either the partially louvered or solid, flush-panel shutters. Judging by the shutters that would have hung at the windows flanking the bay windows, the solid shutters would seem the most likely choice. The screw holes do not form any recognizable pattern, but it seems probable that this first shuttering used the halved hardware and handmade screws.

Shutterdogs. There are two types of shutterdogs, both of "propellor" construction, with the tip of one blade curled out for ease of fastening. The first type has blades of about equal dimension, while the second has a much larger blade opposite the curled one. Both kinds appear with the oldest type of shutter on the exposed second-floor west and east elevations, but only the latter appears with the oldest type of shutter on the sheltered east piazza. Too, the second kind looks to be of thin, irregular, wrought construction, while the first appears to be thick and machine-cut. It thus seems that the uneven-blade variety is the older, and probably contemporaneous with the earliest (1802-1820) shuttering. Most of the shutterdogs' fasteners are replacements.

Latches. There are also two types of shutterbolts and receivers. The first is an early, flat, rectangular slide moved by means of a downturned end terminating in a point. Its receiver has two flat keepers three-quarters of an inch apart. Both pieces are mounted on fairly narrow back plates. The second type of shutterbolt and receiver is later and more elaborate, and is found only on the triple-hung windows' shutters. It consists of a barrel bolt and receiver with ring-pull, mounted on wide back plates having decoratively cusped ends.



Illustration 80. The Grange: West Elevation, Shutters of Triple-Hung Windows (1962).



Illustration 81. The Grange: West Elevation, Replacement Sidelights of Main Entrance (1962).

Finally, there are two types of shutter fasteners, which seem to have been used in conjunction with the bolts when the shutters were closed. The smaller type consists of a tab, pierced by a hole, attached with an eye-bolt near the bottom of each shutter. The tab fits over a pin set into the sill. This type of fastener is used on the shutters of the double-hung windows. The larger type is a strap mounted midway up on the shutter; its bottom edge has a notch that fits over a button mounted on a back plate on the opposite shutter. These are used on the shutters of the triple-hung windows. They appear to be as old as the tabs, however, and may well have been reused from the earliest shuttering.

For more information on shutter hardware, see Appendix N, "Hardware Analysis."

J. Exterior Doorways

Main Entrance

The front door (Ils. 45, 46) is original, judging from the style of its panel moldings -- much like that of the panel moldings on the original interior doors. (See Appendix M.) Photographs show that it was moved, with most of its surround, from the south to the east elevation in 1889. (The outermost of each pair of flanking pilasters was lost.) Its sidelights, initially evincing the same leaded pattern as the side panels of the second-floor triple window, [26] were broken by vandals after 1955 and not restored (Ill. 81). The original leaded fanlight, mounted in its rectangular transom, is intact. The light is recorded in Appendix G, sheets 4 and 8, and Appendix H, sheets 13 and 16. In the top two corners are rosettes in lead. The lead buttons at the junction of each of the rays of the light are in the form of a cluster of three leaves; the lead buttons in the two lower corners are clusters of two leaves.

Side Entrance

The side door, also on the west elevation, has panel-molding profiles similar to those of the original doors. It is assembled with wire nails, however, and is therefore a replacement. Old photographs (e.g., Ill. 62) show that the original rear door was removed at the time of the 1889 relocation. A search of the Grange premises found no old doors that would fit into the original rear-door opening, indicating that this rear door was lost sometime after 1889. The present side entry was not cut through until after 1903 (Ill. 63); it first appears, protected by a storm porch, in 1912 (Ill. 64). The door itself (Ill. 65) comes into view only after the box was removed c. 1933 (Ill. 75). Thus, this particular door leaf could date from any time between 1903 and 1933. The transom light above this door (Ill. 66) probably was installed at the same time as the entry was created, although its initial position inside the storm porch would have restricted its usefulness. The transom would have been necessary to fill in the opening left by the removed window, which extended higher than the standard door opening. First documented in the 1930's (Appendix G), the transom light is much more crudely made than the original front-door transom light. It consists of wooden bars in a fan pattern mounted against a single piece of glass to give the impression of leaded glass.

Basement Entrances

The basement entrances on the west and east elevations date from the move of 1888-1889, and so are not historic. They are in good condition, however, having been examined in 1978-1979.

NOTES

1. Fiske Kimball, Domestic Architecture of the American Colonies and of the Early Republic, p. 88.
2. Memorandum, Barry Sulam to Howard Gliford, June 27, 1979. Copy in North Atlantic Preservation Center files.
3. Ibid.
4. C.R. Meyer, "Roofing with Wood Shingles," Old House Journal, Vol. V, No. 8, August 1977, pp. 85, 93-95; Charles E. Peterson, The Rules of Work of the Carpenters' Company of the City and County of Philadelphia, pp. 5-6; and Rita Gottesman, The Arts and Crafts in New York, Vol. 2, item #757, p. 233.
5. Gottesman, Arts, Vol. 3, item #458, p. 182.
6. Meyer, "Roofing."
7. File #14, Superintendent of Manhattan Sites files, Federal Hall.
8. Report of New York City Landmarks Preservation Commission, File #6, Superintendent of Manhattan Sites files, Federal Hall.
9. Kimball, Domestic Architecture, p. 194.
10. Ibid., pp. 220-221.
11. Ibid., p. 222.
12. McComb drawings.
13. Newton P. Bevin, Historic Structures Report, Part II, Architectural Data Section, on Restoration of Hamilton Grange, p. 5.
14. Peterson, Rules, p. 35.
15. Gottesman, Arts, Vol. 2, p. 340.
16. Ibid., p. 287.
17. Letters from the Secretary of the American Scenic and Historic Preservation Society to Robert Sutherland, carpenter, March and April 1937, copies in Mongin card file under 1937, Federal Hall. (Note: most of these were missing from this file in 1978.)
18. Ibid.
19. Nearly all of McComb's drawings show double-hung, six-over-six windows.
20. Kenneth and Anna M. Roberts, editor and translator, Moreau de St. Mery's American Journey, 1793-1798, p. 147.

21. Gottesman, Arts, Vol. 2, Item #1146 1791 A(nton) Ogilvie glass 16 inches by 12 inches. Item 1158 1791 Wm. Cowley glass 16 inches by 12 inches available from Bristol. Item #1161 1795 Boston Glass any size from six inches by eight inches to 19 inches by 13 inches "superior to imported." There are, however, no ads for glass of the larger size used at the Grange -- approximately 12 inches by 17 inches.

22. Ibid.: Item #808 1791 New York East River Air Furnace sash weights. Item #809 1792 New York East River Air Furnace sash weights: 56, 28, 14, and 716 weights.

23. Ibid., Vol. 3: Item #704, Matthew Hawkins window sashes, one and three-quarter inches thick.

24. Peterson, Rules, p. 8, and Asher Benjamin's pattern books.

25. Letter from Secretary, American Scenic and Historic Preservation Society, to Robert Sutherland, carpenter, April 2, 1937, copy in Mongin card file under 1937, Federal Hall.

26. Compare drawings of original front-door sidelights (Appendix G, sheets four and eight) with existing sidelights of tripartite window.

III. EXISTING CONDITIONS: INTERIOR

A. Synopsis of Original Elements

This section describes the most important original components of the Grange's interior, and tells by what methods they can be dated.

Framing

The framing of the original Grange — i.e., the first and second floors, and the attic — rests upon the exterior rubblestone foundation walls, and on two east-west, interior lines of support extending across the basement and subbasement. Timbers are hand-hewn, while joists and studs are sawn. The oak sills measure eight by 12 inches. The joists measure about three by 10 inches, and are laid north-south. At the first-floor level, the joists are tenoned into the sills and into beams atop the bearing walls in the basement. At the second-floor and attic levels, they rest on the outside-wall girts and on east-west bearing partitions located above the aforementioned bearing walls. The east-west bearing walls are built of studs and brick nogging; non-bearing partitions are of similar construction, but lack the brick (Ill. 82).

The attic framing is discussed in Section E.

Most of the framing today is original, based upon its appearance. The only exceptions are found in areas where remodeling took place. These exceptions are discussed in the sections on the rooms in which they occur.

Generally, the framing system is now in stable condition. Two separate structural problems that arose over the years have been remedied. The first one required that a steel beam and lally column be installed in the subbasement, between the two stone chimney foundations. These foundations form two sections of the northern interior bearing wall at this level (see Illustration 74). The timber that was installed between them as a third section in 1888-1889 failed quickly. It is possible that the situation was exacerbated, or even caused, by the fact that the Grange was relocated directly over a spring or stream, seen in Illustration 24. The result was the settlement of the northern bearing wall in the basement, and of the northern bearing partitions on the two floors above it. This caused wall studs to separate from plates, doorway frames to deflect, and interior plaster finishes to crack.

The greatest separation of studs from their plates occurred at the attic-floor level. The most separation between floor joists and their girts occurred at the second-floor line. The largest amount of deflection took place among the second-floor doorway frames, with a lesser amount suffered by those on the first floor. The cracking of plaster wall surfaces and cornices was most severe along the northern bearing partition.

The settlement that caused these problems began, as mentioned, shortly after 1889. An attempt was made in 1933 to correct the problem, but it took the steel beam — installed in 1967 at the subbasement-ceiling level — to halt the settlement.

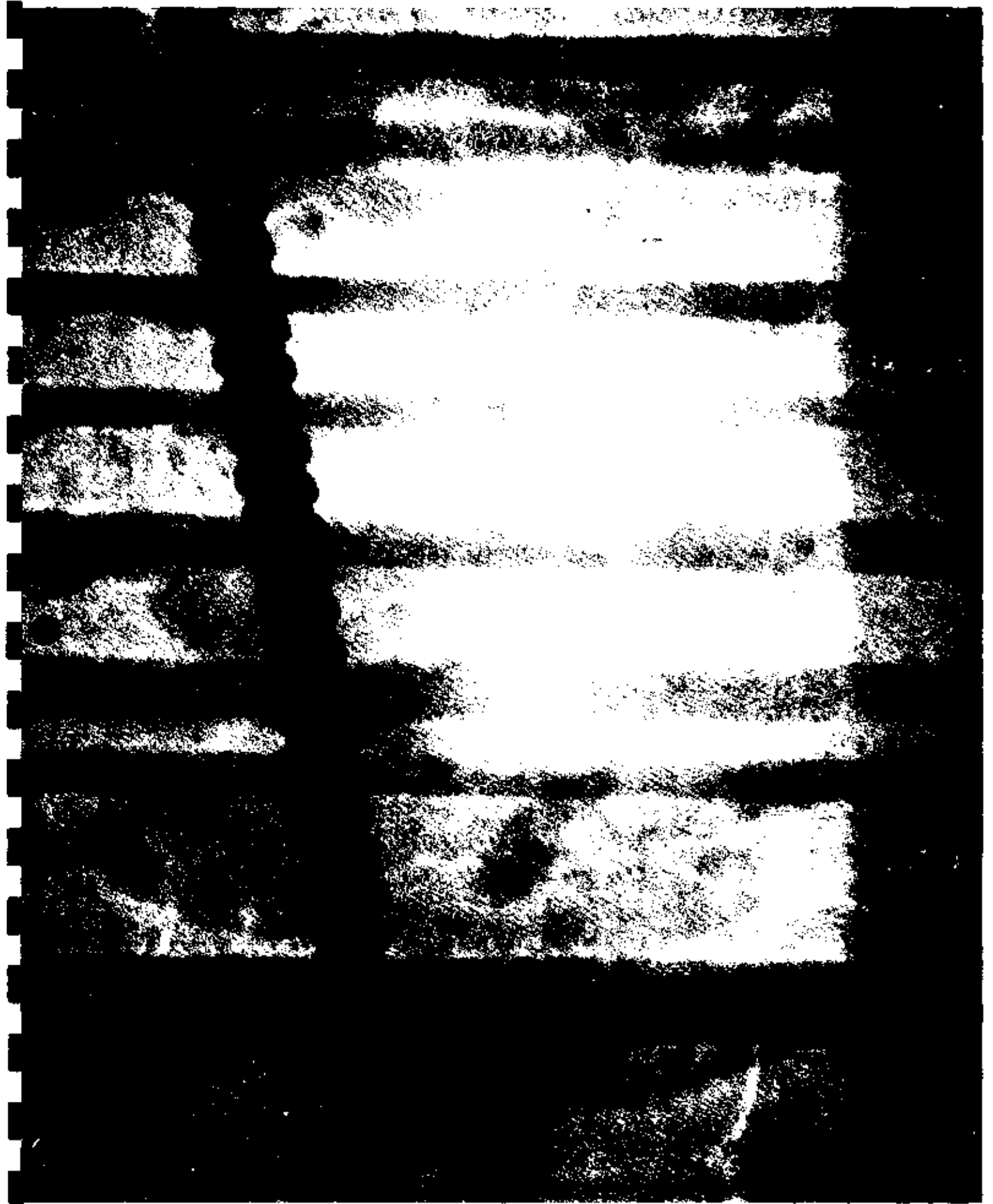

Illustration 82. The Grange: X-Ray Showing Construction of Nonbearing Partition Walls (1977).

A structural inspection made in April 1980 by the New York architectural firm of Meadows/Woll found the beam to be "in tight contact with the wood joists above, indicating that it is functioning as a load-bearing member." Also, the plaster of the floors above has stopped cracking.

The second structural problem required the original brick nogging to be removed from between and below the windows of the second-floor east elevation. In this area, the weight of the bricks over the bay window below proved to be too much for the framing supporting it: the wall studs at the second-floor level broke. During the work of 1978-1979, the wall was opened up. The nogging was removed from between and below all four windows, but not from between the outermost windows and the corners of the house. Plywood then was nailed to the studs, spanning the breaks, to arrest the settlement occurring in this area. For related information, see Chapter II, Section E, "Clapboards" and "Sheathing."

The structural deformations stemming from these two problems were stabilized but not repaired, because it was thought that such action would have destroyed too much original fabric. Cracked plaster surfaces, however, remain throughout.

Insulation

Between most studs is the original brick nogging, as recommended by General Schuyler for rat-prevention purposes. This is laid in a mortar consisting of approximately one part lime, one part clay, and one and one-half to two parts sand.[1] There is no nogging in the vicinity of the original north, rear door, nor in the vicinity of the original south, front door. However, the latter cavity was exposed in the course of the siding work of 1978-1979, and the opportunity was taken to fill it with six inch-thick fiberglass insulation. (The rear-door cavity was not exposed, and so was left empty.) The same material was introduced between and below the windows of the upper east elevation, to replace the removed nogging.

Brown plaster two inches thick is laid on one inch-thick boards set between the joists of the first and second floors (Pl. 83); the boards rest on one by two-inch cleats. This apparently was done for fireproofing purposes. The top of the plaster is about two inches below the bottom surface of the floorboards.

For more information on both mixtures, see Appendix P.

Lath and Plasterwork

Hand-split lath was used throughout, over studs and ceiling joists. To these were applied three coats of plaster: a scratch coat, a brown coat with hair as binder (often scored), and a hard, white, finish coat. The total thickness for the three coats is approximately one inch. In his proposal of 1801, McComb noted that the interior walls would be "set in white," presumably a description of the finish plaster coat. Additional information is contained in Appendix P.

Six plaster cornices exist in the Grange today, all slightly different. Five are located in first-floor rooms, while the sixth is in the second-floor north room. Although heavy, all but one of the cornices are within Federal-period stylistic norms. (The entry-hall cornice is later.) Another reason to think the five original is McComb's proposal of 1801, which specifies stucco — or plaster — cornices for all first-floor rooms. However, the two first-floor north rooms do not appear to have received such treatment, while the large north room on the second floor did. Apparently this was the result of an agreement between Hamilton and McComb during the construction of the Grange, because the second-floor room's cornice is definitely original: portions of it were covered over by the partitions installed in this area between 1810 and 1820.

For additional information on interior finishes, see Chapter IV.

Millwork

Most of the Grange's original woodwork is still intact, being identifiable by its molding profiles and wrought nails. The diverse combination of molding types used for door and window casings, door panels, and baseboards reveals McComb's consideration for subtle architectural detailing. Especially interesting is the way in which the scale of moldings is related to the size and importance of the rooms in which they are used. Molding profiles are provided in Appendix M, and are discussed in the sections dealing with individual rooms.

The wooden picture molding used throughout the house is not original. Judging by the wire nails used for its attachment, and by the number of paint layers it bears, it appears to have been added by St. Luke's Church. It also encircles the second-floor southwest room, which was created in 1889.

Floors

Every original room retains its historic, tongue-and-groove, spruce flooring, based upon the number of wrought nails extracted from them (see Appendix O). The tongues and grooves are not centered along the boards' edges, but offset one-quarter of an inch toward their top surfaces. The rooms of the first floor have floorboards between five and six inches wide. This relatively narrow width would have minimized warpage. However, these boards would have been more laborious to lay, and therefore more expensive. Hamilton thus opted to have larger boards — about 12 inches wide — used on most of the second floor. (The narrower boards were used for the second-floor stair-hall closet, and for the front hall that contains the tripartite window.)

All of the narrower boards were blind-nailed, to make them even more formal in appearance. The wider boards of certain second-floor rooms also were blind-nailed, to achieve at least a modicum of formality. The wide floorboards of other second-floor rooms were simply surface-nailed.

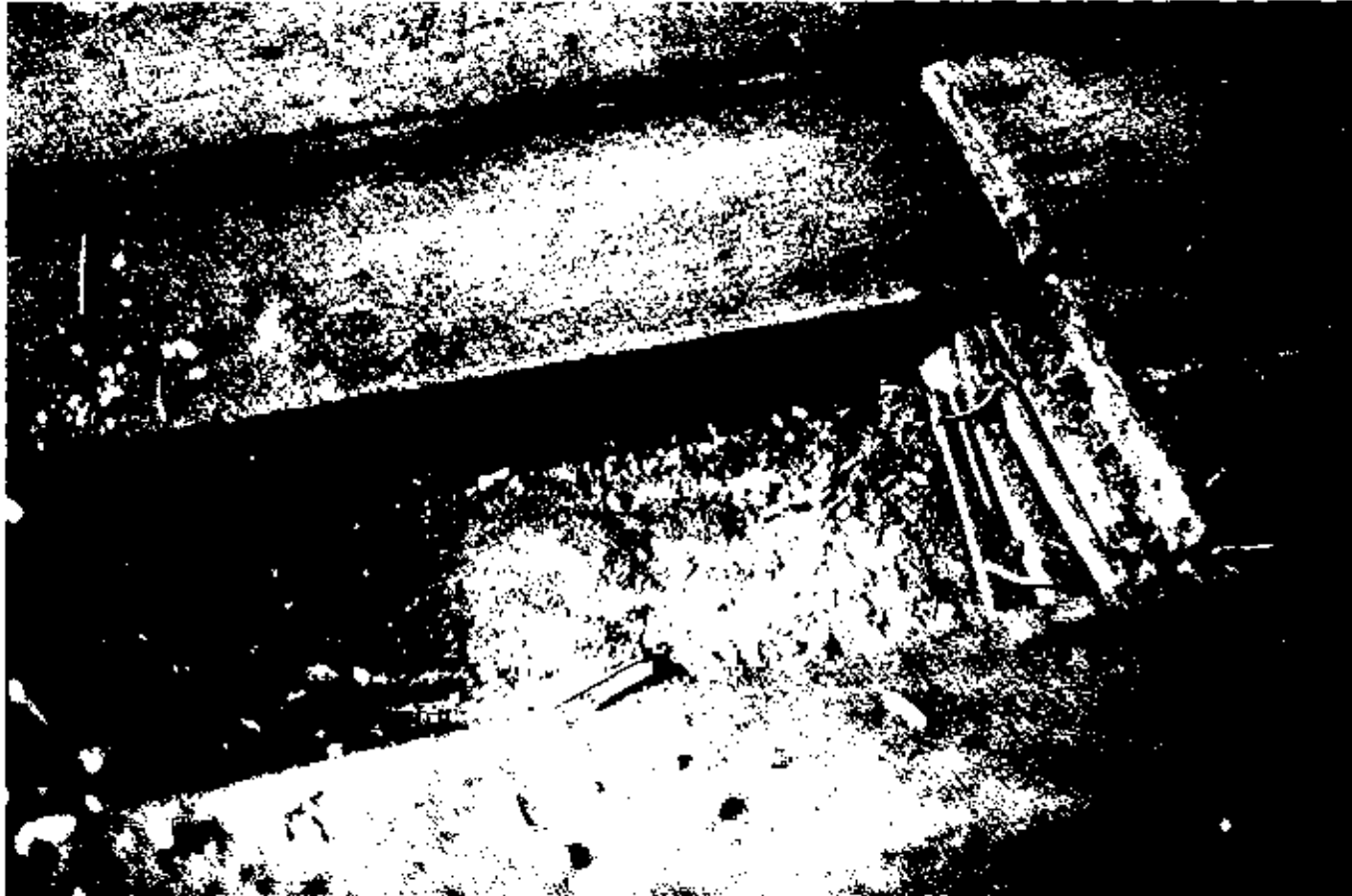

Illustration 83. The Grange: Plaster Laid Beneath Floorboards (1977).

This variety illustrates the quality of flooring available c. 1800. The 1786 Rules of Work of the Carpenters' Company of the City and County of Philadelphia describes three types of successively more costly flooring. The lowest-priced floor consisted of boards of unspecified widths. The next in price used floorboards six to seven inches wide. The most expensive floors were boards three to six inches wide. If the boards were tongued, they were more costly. And "if such boards are nailed in the edge [i.e., blind-nailed], the heading joints are tongued, add 1/4 of the prices to each of the...articles." [2]

The floors probably were left unfinished in Hamilton's time, judging by their appearance now, and by what was done in similar houses elsewhere. A large number of nail holes attest to the presence of wall-to-wall carpet in some rooms at some time, but these could easily have come from posthistoric carpeting.

Nonhistoric flooring includes the various infill patches introduced in 1889, and the two c.-1933 floors laid over the original ones in the first-floor northwest room and north hall. These two dates are based upon documentary evidence of work done in those years.

Fireplaces and Mantels

McComb's proposal for building the Grange, quoted by Mongin, included the construction of eight fireplaces, "...exclusive of those in the Cellar Story." (There were at least two fireplaces in the original cellar, which was left behind during the 1888-1889 relocation.) These were located in the rooms abutting the two working chimney stacks, i.e., the two stacks closest to the north, original rear elevation. Today, only seven of the fireplaces remain. Each octagon room has a fireplace, as does the first-floor northeast room; on the second floor, each center room and each north corner room has one. The only room abutting a working stack that does not have a fireplace is the first-floor northwest room. However, investigation of this room by members of the North Atlantic Historic Preservation Center during the summer of 1978 found a soapstone hearth beneath the present floorboards, framed into the old flooring in front of the chimney stack. This fireplace could have been closed up at any of several times: 1903-1912, about the time the side door was cut through into the room; in 1914, when Mongin reports that the room was converted into a kitchen for the rectory; or in 1933, when the kitchen was removed and the new coal-fired boiler flue was run up this stack.

Concerning the construction of the fireplaces, Mongin shows that Hamilton embraced the principles of Count Rumford, the late 18th-century pioneer in the study of heating and lighting. Consequently, all of the Grange's fireplaces are quite shallow, and all had either iron firebacks or iron backs and sides.

Certain items in McComb's proposal apparently were changed during construction. His proposal of 1801 called for marble mantels in the two octagon rooms. However, George A. Townsend's report of 1886 — excerpted in Mongin's text — discusses these rooms' fine wooden mantels. This suggests that the idea of marble was abandoned in favor of wood, which was used for the other fireplaces.

The wooden mantels of the four upstairs fireplaces are the ones originally put there, judging by their design and undisturbed condition. They were executed in matching pairs, for the two sets of rooms here. The simpler type is seen in Illustration 19, and recorded in Appendix G, Sheets 2, 5, and 7, and in Appendix H, Sheets 4 and 5. The more elaborate is seen in Illustration 20, and recorded in Appendix G, Sheets 1, 3, and 9, and in Appendix H, Sheets 8-11.

The octagon and first-floor northeast rooms' mantels — presumably even more refined in design — were removed between 1883 and 1886 by William DeForest, Sr., then owner of the Grange. Mongin believed that he probably reinstalled them in his Manhattan townhouse. Examination in 1964 of the walls above the Grange's marble replacement mantels revealed wooden grounds and old plaster edges indicative of mantels approximately five feet, one inch high.

It is unlikely that the northwest room's mantel was taken at this time. The discovery of the soapstone hearth meant that the hearth here had not been replaced with marble, which was done when the marble replacement mantels were installed in the other three rooms. The utilitarian style of moldings in this room suggests that the mantel would not have been fancy enough to interest DeForest. Since no unused mantels are stored at the Grange, it appears that this fireplace's mantel has been lost.

Stairs

The original location of the main stair has been described in Chapter III of Mongin's Historical Data Section. McComb apparently chose this location in a side room to create a symmetrically ordered plan, although by that time, contemporary Federal architects were experimenting with circular or elliptical stair halls. The stair cut awkwardly across the lower half of the window in the side room, but McComb did not want to disrupt the proportions of the exterior facade by positioning the window elsewhere.

The move of 1888-1889 required that the main stair be relocated in the original entry hall. The attic stair also was moved; this probably occurred at the same time, but may have been done as much as 10 years later. Most of the evidence for this was uncovered by Henry Judd and Newton Bevin during a 1964 investigation of the Grange. The configuration of the original main stair is described in Section C, "Entry and Stair Halls, Original Form." The attic stair is discussed in Section D, "Center Hall."

There also must have been a stair to the original cellar. The only basement stair extant today is the one built in 1889 as part of the main stair-hall remodeling. The fact that the cellar stair was rebuilt when the main stair was, suggests that both originally were located in the same area, i.e., in the main stair hall. (See Section C, "Entry and Stair Halls, Original Form.")

The location of the original cellar stair may have been dictated by the Grange's compact design, but it would have been inconvenient in actual life. According to McComb's proposal, the Grange's kitchen was located in the cellar, and it had two hearths. This latter fact means that the kitchen must have been one large room abutting both active chimney stacks. Newton P. Bevin's 1964 Restoration Drawings (Appendix J) locate under it the northernmost row of rooms, which seems a likely place. This arrangement would have made getting food from the rear kitchen to the east-octagon, formal dining room quite difficult. It thus seems possible that a second stair led directly up from the kitchen to one of the rear north rooms. Physical investigation has not confirmed this idea, however. The northeast room's original

floor shows no evidence of a stair, and the ornateness of the moldings argues against such a prosaic use of this space. In the northwest room -- the more likely location -- searches below the present floorboards along both west and north walls failed to find any indication of such a stair.

Doorways and Doors

Many of the Grange's present doorways are original, but -- because of remodelings -- a large number are not. These are differentiated chiefly by their locations, with respect to known changes, and by their casings, which are datable both via their moldings and nails.

There are basically three categories of doors at the Grange, discernible by means of their panel moldings. The first includes the original Federal-style doors; these are found in situ on the first floor, in storage in the second-floor northwest room, and leading to the southern and center rooms of the second floor (Appendix G, Sheet 7, and Appendix H, Sheets 3 and 24). The second group consists of the three Federal-style doors introduced when the large north room was subdivided between 1810 and 1820 (Appendix G, Sheet 9, and Appendix H, Sheet 7). The third group includes the single Victorian door, the 1889-remodeling doors, and the 20th-century side door. All doors are six-paneled, except for the second-floor northeast room's closet door, which is four-paneled.

There also are four seemingly original doors used in the basement, but they have such unusual dimensions that their original locations cannot be determined at this time.

In terms of hardware, the front door has a large iron rim lock with brass knob that looks to be original, despite the coat of paint found beneath it. There is another large iron rim lock stored at Federal Hall, which purportedly was taken from the Grange's front door. It is more likely that this lock came from the missing rear door.

Original interior-door locks were of two types, judging by the appearance and placement of the remaining locks. The more important rooms seem to have received steel-case mortise locks of the type still on the doors to the study and west octagon room, and on the center-hall door to the second-floor west center room. Important rooms included all of those on the first floor, and the second-floor center rooms. Before it was subdivided as described by Mongin, the large rear second-floor room also was important, and the door connecting it to the center hall -- now gone -- probably also had a steel mortise lock. The less-important rooms got iron-case rim locks, most likely very similar to that on the north-hall door to the second-floor northeast room. Most of the other iron rim locks extant today are mid- to late 19th-century replacements. Original escutcheons, discernible by their screws, are of brass.

Doorknobs, probably originally brass both upstairs and down, were replaced in the mid- to late 19th-century with marbled ceramic knobs. Downstairs, these in turn were replaced with cut-glass knobs early in this century. First-floor door hinges appear to be mostly five-knuckle, steel, fast-joint butts, having visible pins without finials. Below these hinges are other screw holes that undoubtedly represent the

original hinges. These probably were of the cast-iron, fast-joint butt variety, which was becoming popular when the Grange was built.[3] Original second-floor doors have the same five-knuckle replacement hinges found on the first floor.

For additional information on hardware, see Appendix N.

Windows

Three original types of windows remain at the Grange. A fourth type, used in the original cellar, was lost when the house was moved in 1888-1889. The remaining ones are: 1) the tripartite stair-hall window; 2) the triple-hung, floor-length windows of the octagon rooms; and 3) the double-hung windows, most of which have "panels" beneath them formed by the extension of the casing down to floor level (Ill. 18). Each type of window has a different muntin molding, as seen in Appendix H. The muntins of the stair-hall window have an ogee profile (Sheet 13); those of the triple-hung windows have a cavetto-and-bead profile (Sheet 21); and those of the double-hung windows have an ovolo-and-bead profile (Sheet 2). These moldings, the construction of the sash, and the nature of the glass in the sash, are the main ways in which original Grange sash is identified.

Interior Fixtures

The present interior fixtures (Ill. 84) date from 1933, when electricity was introduced into the Grange. They were designed by Alexander Hamilton — descended from the original inhabitant of the Grange — and Alexander McMillian Welch. These fixtures were designed to be "as nearly as possible like those of Hamilton's time." [4] The fixtures replaced earlier gas fixtures visible in late 19th-century photographs. The original lighting "system" would have consisted entirely of candles, oil lamps, and possibly French Argand lamps.

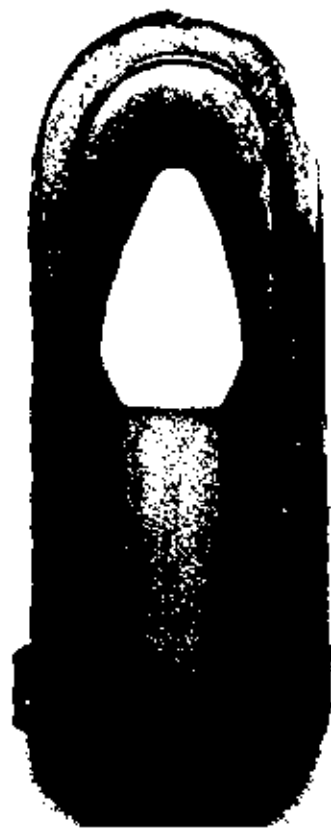

Illustration 84. The Grange: "Reproduction" Light Fixtures (c. 1933).

NOTES

1. Memorandum from NPS Historical Architect Barry Sulam to NPS Project Supervisor Howard Glifort, June 27, 1979. Copy in NAHPC files.

2. Charles E. Peterson, Rules of Work of the Carpenters' Company of the City and County of Philadelphia, pp. 10-11.

3. Untitled English hardware catalog, c. 1800, pp. 7-8; in the Franklin Institute, Philadelphia, PA. See also the Illustrated Catalogue of American Hardware of the Russell and Erwin Manufacturing Company, pp. iv-v; and the APT Bulletin, Vol. V, No. 1, p. 43.

4. Minutes, meeting of the board of trustees of the American Scenic and Historic Preservation Society, January 29, 1944.

B. Basement Analysis

The foundation of the Grange today consists of a basement and a subbasement, both constructed in 1889 to receive the house after the move. The original, one-story cellar/foundation was damaged during the move and was demolished shortly thereafter.

Basement

This level is depicted in Appendix K, Sheet 3. It is partially above grade at the west, front side of the house, but — because the house was relocated onto a steep hillside — it sits at second-floor level at the east, rear side (see Illustration 69). Its present form dates largely from 1914, when it was remodeled into living quarters for the sexton of St. Luke's Church. Along the south wall, the southwest corner and center area are enclosed to form a large stair hall. The southeast corner is partitioned off as a storage room. The area beneath the west octagon room is outfitted as a kitchen; that below the east octagon room has no special purpose. Along the north wall, the northwest corner contains a bathroom and an electrical closet; the center area, a smaller bathroom; and the northeast corner, another storage room.

Exterior walls are of rubblestone, surfaced with furring strips, sawn lath, and two-coat plasterwork. Interior walls are of wooden studding, sawn lath, and plaster. The two east-west interior walls support the east-west bearing partitions of the floors above. The northernmost wall's plaster is badly cracked, as a result of the former settlement problem. Ceilings are lathed and plastered. Most of the floors consist of three to five-inch wide, painted, tongue-and-groove boards laid directly on three by nine-inch joists, without any underlayment or subflooring. The west center room has a vinyl-tile floor, while the two bathrooms and the electrical closet have concrete floors.

Most of this material dates from 1888-1889 and 1914, but some original elements remain. The ceiling contains areas of original split lath and old plaster (see Appendix P). Also, three original interior doors seem to have been rehung in this area, judging by their molding styles.

These consist of the two doors opening into the kitchen area, and the door opening into the room below the east octagon room. The closet door and the corner cupboard in the kitchen also look as though they might be original. There are two outside exits. One leads from the southwest-corner stair hall to an areaway below the west piazza; the other pierces the center of the east elevation, linking the east center room with the gallery below the east piazza.

In terms of windows, there are four in the west wall (three in the bay section), along with the outside door. There are three in the south wall; four in the east wall (two and the outside door in the bay section); and one in the north wall.

A limited amount of work was done to this level during the campaign of 1978-1979; this is indicated on Appendix K's Sheet 3.

Subbasement

This floor is detailed in Appendix K, Sheet 2. It is entirely below grade at the west side of the house, but it sits at first-floor level on the east side. This level remains mostly as constructed in 1889. Walls are of rubblestone. The ceiling consists of the exposed framing of the basement floor above. The floor is of concrete.

In addition to the exterior foundation walls, this space contains two east-west lines of support for the east-west bearing walls above. The southernmost line consists of a masonry wall that extends from the southern corner of the east bay window's foundation; it runs two-thirds of the distance to the southern corner of the west bay window's foundation. This wall then turns southward to form a large enclosed stair hall.

The northernmost interior support consists of the two rubblestone chimney foundations and the steel beam running between them (see Section A, "Framing"). This line of support extends most of the way between the northern corners of the bay windows' foundations.

As mentioned, the southeast corner and center area along the south wall are enclosed as a stair hall. The southwest corner is not enclosed. The area just south of the western chimney foundation is the location of the boiler and hot-water heater. The space north of the eastern chimney foundation has been outfitted as a secured area for the storage of artifacts. This is where the original porch components and assorted shutters are stored, as well as several c.-1890 exterior doors.

There are no outside exits at this level. The rubblestone foundation wall supporting the outside edge of the east gallery is solid, without any openings at all. The rubblestone foundation wall supporting the east wall of the main block did have a door in its southern end, which led to a stair that ascended to the floor of the east gallery. However, this had been closed off prior to 1978.

Two small windows sit in each of the north and south elevations walls. These still contain frames and sash, but their exteriors have been infilled with concrete block for security reasons.

Again, the changes made to this level during the work of 1978-1979 are noted on Appendix K's Sheet 2.

Original Cellar

In 1886, George A. Townsend's account of his visit to the Grange noted that "Mr. Allen says that the basement of the Grange is the most interesting portion of the house at the present day." Unfortunately, the original Grange cellar — destroyed during the move — was not well documented. Illustration 15 is the only record that remains, and it errs in several important respects.

Newton Bevin's Basement Restoration Plan (Appendix J, Sheet 1) reflects most of the information known about the original cellar. The mason's specification quoted in Allan M. Hamilton's Life of Hamilton includes such details as "to lay both kitchen hearths with brick placed edge ways"; "to put a strong iron back in the kitchen fireplace five feet long by 2-1/2'-9" high"; to provide an iron door for the oven mouth"; and "to build stew holes and a wall for the sink." McComb's account book of 1802 lists "1 iron bar for the Ironing room chimney."

This information seems to imply that the kitchen was long enough to abut both chimney stacks. This would most likely mean that it extended the full width of the house, below the northernmost row of rooms. One fireplace would have been used for open-hearth cooking, and probably was equipped with a bake oven. The other stack could have served the stewholes. These may have been part of a Rumford stove--one 1803 bill (Ill. 28) includes a "kitchen range." Hamilton applied Rumford's principles elsewhere in the house, and may well have followed them in this area as well. Another up-to-date feature in the Hamilton kitchen would have been the sink. An original bill notes payments for pipes, which probably were used to drain water from the sink. It is possible that they also brought water in, from a rainwater cistern or other on-site sources.

The ironing room must have abutted a working stack, too, which would mean that it would have been located beneath one of the octagon rooms. Bevin hypothesized that the cellar room beneath the other octagon room was used as a family dining room. This would have been in keeping with the custom of the time, and thus seems probable. Bevin's restoration drawing shows it on the western side of the house, but its position could easily be reversed with that of the ironing room.

Bevin also theorized the existence of a servant's room in the southeast corner, which again seems plausible. Hamilton was away from home much of the time, and his family would have needed some type of protection. However, Bevin's drawing reflects yet another, less defensible, idea. It shows the western chimney stack as being larger than the eastern one. There is no evidence to support this. Bevin probably took such liberty in order to emphasize his hypothesized room plan. In any case, there is no reason to think that the stacks were not the same size.

Other drawings, notably A.D. Anstey's 1933 measured plans (Ill. 74), show a "Drawing Room" in the original cellar. No mention is made anywhere in the original specifications of a drawing room at this level. This error probably stemmed from Anstey's misreading of the original-proposal phrase, "ironing room."

C. Room-by-Room Analysis: First Floor

The first floor is depicted in Illustration 85.

Entry and Stair Halls

The present-day entry and stair halls occupy the western and center portions, respectively, of the southern third of the Grange's first floor. They form one large room, and share many of the same design features. The stair hall is actually pentagonal in shape, having a triangular "apse" at its north end.

Ceilings and Walls. The ceilings are lathed and plastered, as are the walls. There is no dado. Most of these surfaces seem to be original, judging by the ghosts of original features discovered in the plaster during the 1964 investigation. The exception is the eastern portion of the entry hall's ceiling. This was where the original stairwell pierced the second floor, and where an infill patch was introduced when the stairwell was closed up in 1889 (See Section D, "Southwest Room.")

Cornices and Baseboards. The large plaster cornice in the entry hall and main part of the stair hall is a replacement, installed when the positions of the original center entry hall and southwest stair hall were reversed in 1889. It is much heavier than the other cornices in the house, and it continues unbroken along walls that before 1889 were intersected by partitions.

The original entry hall (present stair hall) must have had a cornice, judging by McComb's proposal of 1801. It probably resembled the apparently original cornice remaining in the adjacent "apse" -- the triangular area divided from the rest of the hall by an arched doorway. (See Section A, "Lath and Plasterwork.") This is the case in the north hall and apse, both of which seem to have their original cornices. It is less certain that the original stair hall (present entry hall) had a cornice. McComb's proposal would indicate that it did, but the space was very simply treated in all other respects. There is no clue as to what this cornice would have looked like.

The baseboard moldings in this area are also a mixture of styles that bear witness to the changes that took place in 1889. (These moldings, like all Grange moldings, are categorized by type in Appendix M.) The elegant molding on the east wall of the stair hall, and on the north wall east of the arch, survives from the original entry hall; it is the simpler version of the "fancier Type A" baseboard used in the east octagon room. The baseboard inside the apse is different from this, but also appears to be original: it is the simpler version of the "Type B" baseboard used in the west octagon room.

The "fancier Type G" molding used nearly everywhere else in the entry and stair halls -- and up the stair -- clearly dates to 1889. Its profile is very sculptural, and the north-wall section runs unbroken along a wall originally bisected by a partition. Too, the original, compact stair did not have a run long enough to furnish the baseboard section presently used along the main stair run. A short section of similar but less-ornate 1889 baseboard ("simpler Type G") is found on the south wall of the stair hall, in the former vicinity of the main entrance.

Floors. Except for an infill patch of flooring at the foot of the main stair (Ill. 86, left center), the floorboards in both halls are original, if heavily rained. These floorboards are the finer, blind-nailed type used at the Grange, measuring between five and six inches wide (See Section A, "Floors.") Most of the boards of the infill, judging by the machine-cut nails used to fasten them, were part of the 1889 renovations. A few original boards were reused from where the new stairwell was cut through.

Main Entrance. The current front-entrance treatment is mostly original, although moved to its present location from the center of the south elevation in 1889. The entrance is depicted in Illustration 46, and recorded in Appendix F, Sheet 9; Appendix G, Sheets 4 and 8; and Appendix H, Sheets 16, 17, and 23. The unusual design of the fanlight — set in a rectangular transom — has already been discussed in Mongin's Historic Data Section, on page 31.

Neither the muntins nor the glass of the present sidelights (Ill. 81) are original. They postdate 1955, being installed after vandals destroyed the original sidelights. According to Mr. Daniels, then the caretaker, what remained of the original glass and casing was thrown out. Measured drawings from the 1930's make it clear, however, that the original sidelights displayed the same form as the present sidelights of the tripartite window, which would have been located directly over the front doorway when the house was built. The casing of the front doorway ("fancier Type B," in Appendix M) seems original, in that it is a more elaborate version of the casings found around the other doors leading from this area. The paneled shutters of the sidelights, and the front door itself, also are original, judging from the style of their moldings, the size of the door, and the hardware used on both items. As mentioned in Section A, "Doorways and Doors," the front door's rim lock is thought to be original.

Interior Doorways and Arch. There are three extant interior doorways in the entry and stair halls, not including the arched opening that separates the main part of the stair hall (former entry hall) from its northern "apse." The three doorways lead from the apse into the west and east octagon rooms, and from the stair hall into the southeast room. Judging by their locations and casings, they are original. The first two doorways' moldings are the "fancier Type B" casing, as outlined in Appendix M. The doorway to the southeast room displays the simpler version of this same casing type. The doors that hang in these openings are discussed in the sections on the rooms into which they open.

The arch here is one of the most beautifully ornamented elements in the Grange. Its southern and interior surfaces are decorated with a delicate floral garland in composition bas-relief. Judging by their appropriateness of style and their appearance in old photographs, these decorations are assumed to be original to the house. Detailed drawings are found in Appendix G, Sheets 6, 11, and 13, and Appendix H, Sheets 25-29.

Window. The sash of the window in the present entry hall appear to be original. The profile of the muntins matches those of most of the other double-hung windows in the house. The casing of the window, however, is not found anywhere else in the Grange (see Appendix M). It either was designed specifically to accommodate the original stair — whose major landing crossed this window — or altered in 1889.

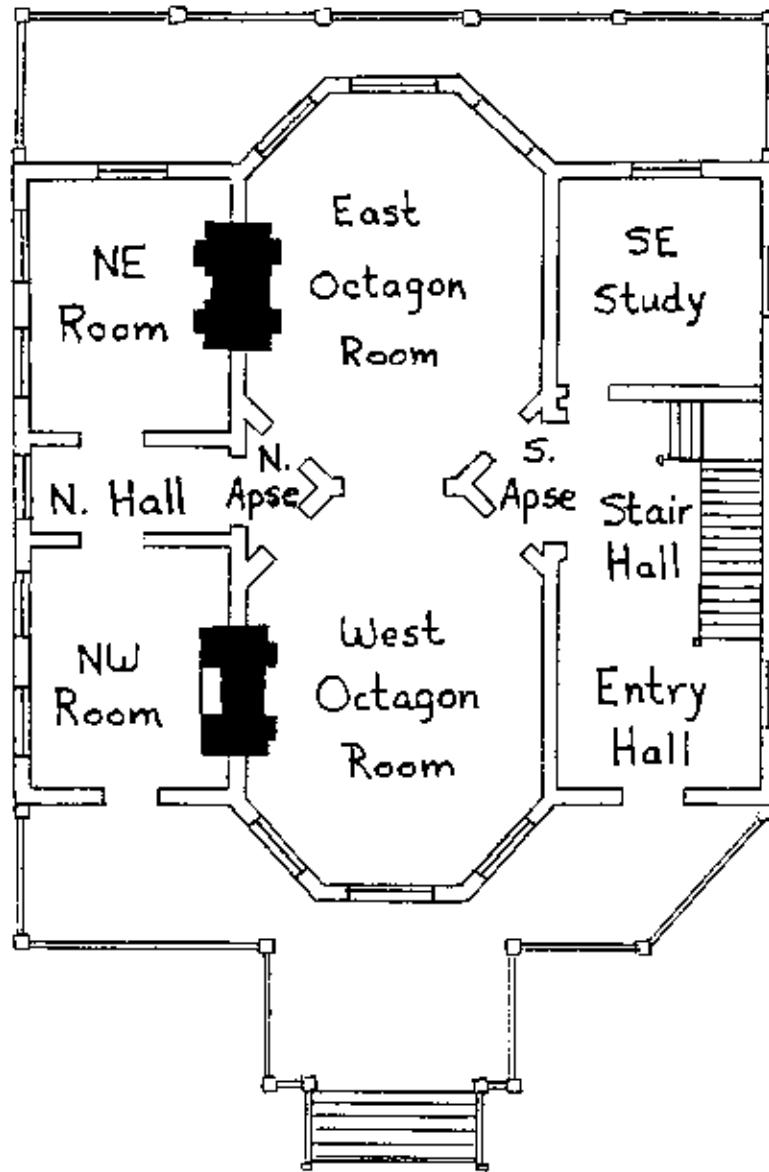

Illustration 85. The Grange: Plan of Present First Floor.



Illustration 86. The Grange: Entry Hall, Floorboard Evidence of Original Main Stairwell (1977).



Illustration 87. The Grange: Entry Hall, Framing Evidence of Original Main Stairwell (1964).



Illustration 88. The Grange: Entry Hall, Plaster Scars from Original Main Stair Hall Partitions and Stair (1964).

Stair. The present main stair (Ill. 53) was built in 1889, to replace the original one taken down to make room for the relocated main entrance. Much original material seems to have been reused, however. The treads show a great deal of wear -- much more so than does the nosing at the top of the stair. The nosing also is of the wrong shape to have come from the original stair. One of the present risers yielded up a hand-wrought, rose-headed nail. And there are the same number of treads and risers -- 18 and 20, respectively -- that the 1964 Judd-Bevin investigation deduced the original stair would have had. The dimensions are slightly different, however. It thus seems likely but not certain that the treads and risers of the first stair were reused in the new stair. The moldings of the balustrade and newel are clearly Victorian.

The stair to the basement -- under the main stair (Ill. 53) -- may incorporate elements of the original cellar stair.

Original Form. This area is one of the most altered in the house. The earliest record of the interior plan of the Grange -- written by James C. Carter in 1854 -- describes the original entry hall as being pentagonal and centered on the house's southern wall. It says that the main stair was located in a room entered through a door directly opposite the entrance to Hamilton's study (the southeast room).

When the Grange was relocated in 1888-1889, the west elevation became the principal one. The front door and its enframement was moved from the center of the south elevation to the south end of the west elevation, such that it opened into the side of the original stair hall (Ill. 41). The stairs had to go, of course, so they were rebuilt farther east, in the vicinity of the former entry hall. In short, the positions of the center entry hall and corner stair hall were reversed.

This understanding came largely as a result of the 1964 Henry Judd-Newton Bevin investigation, with additional information being supplied by this author in 1977. Basically, the physical evidence consists of: (a) the c.-1889 patches of infill flooring used to close up the original stairwell at the first- and second-floor level; and (b) the scars left in the north-wall plaster of the present entry hall (former stair hall), which document the position of the east and west walls of the original stair hall, of the uppermost main-stair landing, and of the last run of the main stair.

Illustration 86 shows, at left center, the infill flooring at the first-floor level. Original floorboards can be seen in front of, to the right of, and behind the infill patch. Illustration 87 depicts the opening that Judd and Bevin made in the infill patch in 1964. Inside the opening, one can see the infill joists butting up against an original header (seen to the right). These joists are smaller than the original ones, and they do not have the layer of original brown plaster laid between them as fireproofing.

Illustration 88 shows the north-wall plaster scars. At far left is seen the outline of a partition. This lines up with the westernmost edge of the first-floor infill patch -- the far line in Illustration 86. This means that the original stair hall did not extend all the way to the west exterior wall: a narrow closet seems to have been sandwiched in between the stair hall and the west wall. (There is even stronger evidence for such a closet having existed at the second-floor level.) This explains the strip of original flooring west of the infill, just inside the present front door. This was the floor of the original closet.

Illustration 88 also yields much information about the configuration of the original main stair. Just to the right of the closet-partition scar is the outline of a landing about two-thirds of the way up the wall. This outline connects with a scar left by the uppermost run of the stair. This means that the second run must have ascended the closet partition wall. The 1964 investigation concluded that the angle of the stair scar indicated a total figure of 20 risers, each approximately seven and five-eighths inches high, with 18 treads measuring just under 10 inches.

Illustrations 89 and 90 chronicle the evidence for the location of the stair at the second-floor level. Illustration 89 shows the original flooring of the west-wall closet at the rear, with the infill flooring in the foreground. Unlike at the first-floor level, the cut between the two sections here extends all the way to the north wall, because the third run of stairs ascended this wall. Therefore, the closet had to be reached from the adjacent room, via the door seen at far right. Illustration 90 shows the eastern edge of the infill patch, which falls just inside the doorway to the present southwest room. (The infill is on the far side of the cut.) This is the precise spot where the third run of stairs would have emerged.

Illustration 91 shows the southeast corner of the southwest room. Imbedded in the south wall -- under a plaster patch -- are the remains of a wooden handrail. Directly below this is a cut in the baseboard. This means that the original stair balustrade turned right at the top of the main stair and continued on to intersect the south wall at the place seen in Illustration 91. Therefore, the wall in this position today, which divides the southwest room from the second-floor front hall, is not original.

The location of the cellar stair can be deduced from the information gleaned about the main stair. Both were located in the main stair hall, as mentioned in Section A, "Stairs." The size of the infill patch at the first-floor level seems to indicate that the two stairs must have been built side by side. Since it is clear that the first run of the main stair occupied the eastern half of the stairwell, the cellar stair must have occupied the western half. This would mean that its first run would have descended along the closet partition wall, directly beneath the second run of the main stair. Because of the limited amount of space available, the first run would have had to end at a corner landing, with a second run descending along the south wall to the cellar floor.

Illustration 15 -- the 1888 drawing of the original cellar floor -- shows what appears to be the correct cellar-stair configuration. However, it is drawn in beneath the main pentagonal entry hall. The physical evidence has shown that it was actually located beneath the original stair hall, in the southwest-corner area. It thus appears that the limner of Illustration 15 drew the stair arrangement correctly, but in the space adjacent to the proper one.

It does not seem likely that the cellar stair would have been divided from the first-floor stair hall by a partition and door. This is based upon the form of other Federal-style stairs, which tended to be open and not enclosed; on the difficulty of working a partition into this particular, tight space; and on the fact that the entire stair hall was partitioned off from the rest of the first floor. Nevertheless, evidence for such a partition may yet be discovered.



Illustration 89. The Grange: Second-Floor Southwest Room, Floorboard Evidence of Original Main Stairwell (1977).



Illustration 90. The Grange: Second-Floor Southwest Room, Floorboard Evidence of Original Main Stairwell (1977).



Illustration 91. The Grange: Second-Floor Southwest Room, Plaster Scar from Original Main Stair Handrail (1964).

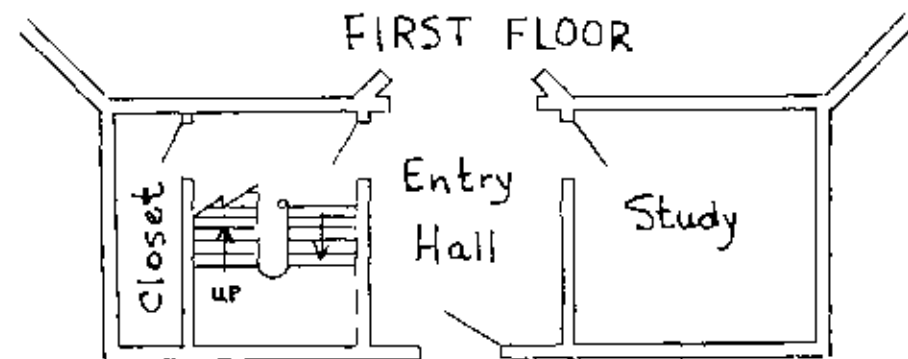
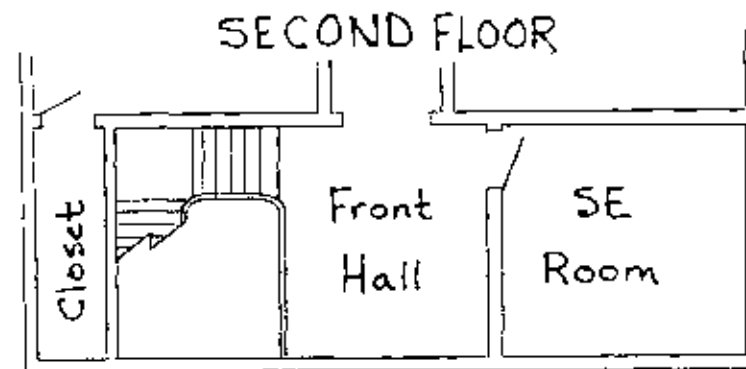

Illustration 92. The Grange: Conjectural Plan of Original Main Stair.

In summary, the Grange's original stairs seem to have been arranged as seen in Illustration 92. The main stair hall occupied the eastern two-thirds of the southwest-corner area. The western third was a closet. At the first-floor level, the stair hall was entered from the entry hall through a doorway opposite the door to Hamilton's southeast study. This doorway probably contained a door, since all of the other doorways in the hall did. The first run of the main stair began just to the left of the doorway, about three or four feet from the north wall of the stair hall. This run ascended along the east wall to a landing that extended the width of the south wall. This landing's position — at one-third the height of the stair hall — meant that it crossed the lower quarter of the window in this area.

The second run of stairs ascended at a 180-degree angle to the first, along the former closet partition. It ended at a landing at two-thirds of the height of the stair hall — the landing that is represented by the scar in Illustration 88. The third run of stairs left the landing, ascended along the north wall at a 90-degree angle to the second one, and reached the second floor just short of the threshold of the present southwest room.

The wall now dividing the second-floor front hall from the southwest room would not have been present. The hall and the stairwell would have flowed together, with only the continuation of the stair balustrade between them, to guard the precipice formed by the stairwell. Therefore, a person ascending the original stair would have had a totally different spatial experience than nowadays: he would have entered a relatively enclosed space that opened out dramatically toward the tripartite window as he ascended. Too, the stairs would have been lit with natural light.

Returning to the first floor, the first run of the cellar stair would have descended just beyond the first run of the main stair, along the west wall of the hall and directly below the second run of the main stair. This run would have ended at a corner landing, with a second run at a 90-degree angle to the first descending along the south wall.

Returning once again to the first floor, the doorway to the closet would have been located in the west wall, just north of the cellar stair. It undoubtedly would have been hung with a door. The closet itself would have been lit by a window where the front door sits today.

Southeast Room

This room, according to 19th-century accounts, was used by Hamilton as his study, or library. It features a mixture of elements, including both sophisticated and simpler ones. It has apparently undergone little change.

Ceiling and Walls. These seem to be of the original lath and plaster. There is no dado.

Cornice and Baseboard. The date of the plaster cornice here is unknown. McComb's 1801 proposal includes cornices for all first-floor rooms, so there is an excellent chance that it is original. However, its profile is considerably different from those of the other cornices assumed to be original: in the octagon rooms, in the

triangular apses and the north hall on the first floor, and in the north rooms of the second floor. It is not as elaborate as the 1889 entry-hall cornice, and so probably does not date from that remodeling. If not original, it may have been installed in the mid-19th century by the Ward family.

The wooden picture molding nailed beneath the cornice is identical to that used throughout the house, and dates from the occupancy of St. Luke's Church.

The baseboard here is the simpler version of the original "Type D" molding, as seen in Appendix M. It is used elsewhere in the southeast and center rooms of the second floor.

Floor. The floorboards are approximately five inches wide and blind-nailed. Because the floor is in good condition, researchers did not remove nails or lift boards to examine the joists below. Presumably the joists here and fireproofing between the joists are identical to those described in the older sections of the entry hall.

Doorway. The casing of the doorway to the present stair hall is the fancier version of the original "Type C" molding, so the doorway is thus presumed to be original. The door is also believed to be original, as well as its steel mortise lock (see Appendix N).

Windows. The casing of the windows here is the same "fancier Type C" molding used around the doorway. McComb arranged it in an unusual manner, however: the side pieces of casing extend down to the floor, forming a plaster "panel" beneath the window. This design is discussed in Mongin's Historical Data Section, on page 31, and seen in Illustration 18; Appendix G, Sheet 9; and Appendix H, Sheet 2. McComb used the device in all except the simplest Grange rooms, both with relatively ornate casings — as done here and in the second-floor north rooms — and with plainer casings.

The sash of the windows is the same original type used for all of the Grange's double-hung windows, excluding those of the basement.

West Octagon Room

This room, based on the 19th-century accounts, was used by the Hamiltons as their drawing room. It was one of the two most handsomely finished rooms in the Grange, and has retained most of its original character.

Ceilings and Walls. These appear to consist of the original wooden lath and plaster; there is no dado. The ceiling plaster in the vicinity of the bay window is badly deteriorated, due to water that penetrated during the restoration of the piazza roofs in 1978-1979. The rest of the ceiling plaster is in reasonably good condition. The plaster walls, especially the northern one, have been patched several times in this century, to cover cracks that appeared as a result of the failure of the 1889 north bearing wall-support timber. Structural work has rendered the cracks inactive, but they need additional repair.

Cornice and Baseboard. The three-part, solid-plaster cornice appears to be original. It displays cracks and sections out of alignment caused by the 1889 timber failure. This cornice and its twin in the east octagon room may have been the reason for the listing of "stucco enrichments" in McComb's bill of 1803. This term was the common one for plaster moldings at this time. According to the bill, it seems that these cornices were not part of the original contract, and that Hamilton had to pay extra to have them put in. The cornice appears in interior photographs (1892-1900) of the house taken after the Grange had been made into St. Luke's Rectory (Ill. 60). Below the cornice is the later picture molding.

The style of baseboard in this room is the original, "fancier Type B" molding described in Appendix M. It relates to the similar but simpler baseboard in the stair-hall apse. Two later pieces flank the marble mantel (see "Fireplace" below).

Floor. The floorboards are the best-quality ones, measuring between five and six inches wide. They run in an east-west direction, and are blind-nailed with wrought-iron nails. Beneath them, on boards set between the joists, is the two inch-thick layer of original brown plaster used as sound deadening.

Doorways. All three doorways in this room -- including the double doorway to the east octagon room -- have identical casings. They are among the most elaborate ones used in the Grange, being the simpler version of the "Type A" casing discussed in Appendix M. A certain amount of deflection is seen in the doorway casings, again the result of the 1889 structural-timber failure. The plaster around the casings has been patched, however, and the deflections are not very noticeable.

The door from the present stair hall seems original, and it retains its steel mortise lock. The door that originally opened into the rear hall is stored on the second floor, and is labeled Extra Door #2. This door still retains the escutcheons from its original, iron mortise lock (see Appendix N). Double doors -- now gone -- once opened into the east octagon room. Since they hung on the east side of the jamb, they are discussed in the portion of text describing the east octagon room.

Windows. The three windows here are set into the three sides of the projecting bay of the west elevation. They are floor-length and triple-hung: the shutter-hardware evidence indicates that the central one was used as a doorway out to the west piazza. (See Chapter II, Section I.) The casing is the same "simpler Type A" casing that the doorways have. The muntin profile of the sash is more ornate than that of the double-hung windows: each side consists of a cavetto, and the edge is beaded (Appendix H, Sheet 21). All of the sash here is thought to be original (see Section A, "Windows").

Fireplace. The extant marble mantel (Ill. 21) dates from c. 1885, when it was installed to replace the presumably elaborate wooden mantel removed by the then-owner, William DeForest, Sr. An 1883 book that includes interior photographs of DeForest's townhouse shows that the original Grange mantels had not yet been moved there, but they were definitely gone from the Grange by 1886, when George Townsend wrote his description. (See Appendix A.) The original mantel might have exhibited the flower motif used on the pilasters supporting the stair-hall arch. (See Section A, "Fireplaces and Mantels.") The replacement mantel apparently was narrower than its predecessor, which caused c.-1885 pieces of baseboard to be installed on either side of it.

The age of the coal grate is unknown, but it most likely was installed before 1933, when central heating was first introduced to the Grange.

East Octagon Room

This room, again judging by the 19th-century accounts, served as the Hamiltons' formal dining room. It was finished even more elaborately than the west octagon room. Unfortunately, it has experienced over the years some damage and various repair efforts.

Ceiling and Walls. These appear to consist of the original lath and plaster; there is no dado. The ceiling plaster in the vicinity of the bay window has fallen out completely, and portions of the cornice are missing as well.

This nominally was caused by water penetration when the piazza roofs were restored in 1978-1979. However, most of what was lost consisted of a wallboard and plaster patch put in sometime after 1964. This patch was installed after a leak that developed c. 1955 caused the original plaster to fall out (Ill. 93). And there is some thought that even earlier water damage in this area contributed to the decision to raise the piazza roofs c. 1835. The remainder of the ceiling plaster is in passable condition.

As is the case in the west octagon room, the plaster walls evince settlement cracks that have been stabilized, but which remain to be repaired.

Cornice and Baseboard. The plaster cornice here is identical to the original one in the west octagon room, and appears to be original as well. It was damaged in the vicinity of the bay window by the c.-1955 leak, and several pieces were removed and stored in the subbasement. These still contain the early cut nails used to reattach them during the first repair effort, in the 1830's.

Most of the baseboard is the "fancier Type A" baseboard, found nowhere else in the Grange. There are two other types of baseboard here as well. Judging by their locations, they are stock Victorian moldings chosen for their similarity to the original baseboard. One type is found on either side of the mantel, and probably dates from c. 1885, when the original mantel here was replaced with the present one. The other type is used to the west of the fireplace, where the door to the northeast room was closed up. This appears to be a late-Victorian molding, but its nails should be investigated to clarify its date.

Floor. The floorboards are the same expensive type used originally throughout the first floor of the Grange, being five to six inches wide, splined, and blind-nailed.

Doorways. The "fancier Type A" door casings in this room are the most elegant in the Grange; they have the greatest overall projection -- and thus the greatest play of light and shadow -- as well as an unusual combination of curved and flat surfaces (see Appendix M). The doorways exhibit some deflection dating to the settlement that occurred 1889-1967.

The two doors formerly leading to the entry and north halls are gone, but they are stored upstairs. These doors are labeled Extra Door #3 and Extra Door #4, and belong to the south and north doorways, respectively. Both have late 19th-century,



Illustration 93. The Grange: East Octagon Room, Damage to Ceiling of Bay (c. 1960).



Illustration 94. The Grange: c.-1885 Replacement Mantel, East Octagon Room.

cast-iron mortise locks. However, both also bear scars of earlier mortise locks — locks that presumably would have been similar to those used elsewhere on first-floor doors. The escutcheons on both doors appear to be original, since they are fastened with early machine-made screws, with no evidence of previous escutcheons.

As mentioned earlier, the double doors that once hung in the doorway leading to the west octagon room have disappeared entirely; their hinge marks have been patched with wooden "dutchmen." A pair of doors in this position are evident in the 1892-1900 photograph of the room, taken during its usage as rectory drawing room (Ill. 60). These are four-paneled doors — unlike the known original doors — and have a panel molding heavier than that found on an original door that is also seen in the picture. This suggests the four-paneled doors were Victorian additions, replacements for original, six-paneled doors that had been taken down. The latter may have disappeared during the room's usage as temporary chapel (Ill. 56), when both rooms were thrown together.

There is some thought that these four-paneled doors were the original ones. There were four-paneled doors in the Georgian period, of course, but the Grange's definitely Federal date and stylistic sophistication rules out the possibility of the doors being a Georgian "hangover." Of greater weight are historical accounts that speak of mirrors being attached to the doors of the two octagon rooms, to reflect the spectacular river views on either side of the house. In 1854, James C. Carter reported that three west octagon parlor doors were mirrored. Presumably he meant the two doors to the front and rear halls, and the double doors considered as one. George A. Townsend's 1886 account said that both octagon rooms once had mirrored doors, indicating that the mirrors disappeared between 1854-1886. And an 1890 New York Daily Tribune newspaper article (Appendix A) stated that the east octagon dining room's doors were formerly mirrored. Those who think the four-paneled doors original, point out that this configuration would have provided large expanses for these mirrors. But the doors to the halls also were mirrored, apparently, and these are extant and definitely six-paneled.

Investigation of the panels of the original doors — where the mirrors would have hung — for traces of glue or fewer layers of paint is fruitless, because the woodwork seems to have been stripped. Examination of the "dutchmen" neatly patching the hinge marks is equally inconclusive. There is only one set of screwholes visible, and these conform to the five-knuckle steel hinges that seem contemporaneous with the four-paneled doors. But the "dutchmen" are unusually long — as much as 12 inches — and as deep as the door reveals itself. This is much larger than would have been necessary to cover the marks of the five-knuckle hinges only. It thus is possible that there was an earlier set of hinges, offset from the later ones and held by shorter screws, whose holes were cut out completely when the "dutchmen" were installed. It is probable that these early hinges were five-knuckle, cast-iron, fast-joint butts as stated in Section A, "Doorways and Doors."

Examination of the reveals of all four doors in this room show them to have been of double thickness. The two east octagon doors stored upstairs are in fact of this dimension. The reason for this is uncertain. Perhaps it was to minimize drafts created by cold northeast winds; perhaps it was to muffle the sound of the dining room table being set and cleared when the Hamiltons entertained.

Windows. The windows have the same "fancier Type A" casing as the doors in this room do. In all other respects, they are identical to the windows of the west octagon room, already described. Again, the central window seems to have been used as a doorway out onto the east piazza.

Fireplace. Today's marble mantel (Ill. 94) is identical to the one in the west octagon room; it also dates from c. 1885, for the same reason that the other does. It seems probable that the original wooden mantels in both rooms were identical to each other, or at least very similar. There is no coal grate.

Northwest Room

This room, judging by the simplicity of its casings, was not an important room. There is no documentary evidence of its original usage. Considering its proximity to the dining room, it is possible that it was used as a pantry, although the lack of evidence for a stair to the cellar-kitchen seems to rule out this idea. More plausible is the thought that it was used as a bedroom. Mongin has shown that the Grange housed at least eight children, and often more, during Hamilton's years there, and that guests would frequently spend the night. With the second-floor north rooms still one large space — probably a living room — and the second-floor southwest room still containing the main stair, only the two center rooms and the spartan southeast room were available for upstairs bedrooms. One interpretation allots one center room to the male children, and the other to the females, with the southeast room being reserved for the eldest. This would make the first-floor north rooms prime candidates for the elder Hamiltons' bedrooms. There are indications that there were servants' rooms in the original cellar, but it seems unlikely that family bedrooms would have been located there.

Whatever its original use, this room has undergone several "adaptive reuse" schemes. Nevertheless, it has still managed to retain much of its original feeling.

Ceiling and Walls. These seem to be of original lath and plaster, except where the fireplace was closed up. South-wall settlement cracks need to be patched. There is no dado.

Cornice and Baseboard. There is no cornice in this room, and — judging by examination of the plaster and paint — it seems there never was one. This would conflict with McComb's proposal of 1801, which includes plaster cornices for all first-floor rooms. However, Hamilton apparently decided not to have cornices put up in this room, as explained in Section A, "Lath and Plasterwork."

The baseboard is rather coarsely molded, and is the only one of its type in the Grange ("Type E"). There is thus a possibility that it is not original — that it may have been put in as part of one of the various remodelings that went on here. Again, an examination of the nails holding this baseboard would help identify its age.

Floor. The floor today consists of three-inch boards running north-south. It is thought that these date from the 1933 restoration effort, which presumably included the removal of kitchen facilities that had been installed here in 1914 for the benefit of St. Luke's rector. The new flooring would have been necessary to cover pipe holes

and such. This flooring is laid directly on top of older, probably original, floorboards; they match the type originally used throughout the Grange's first floor.

Doorways. The doorway leading to the north hall appears to be original; it displays the relatively simple casing categorized in Appendix M as the "simpler Type D" casing. Its door seems original, too, although it bears a later mortise lock (see Appendix N). The doorway leading out onto the west piazza has the same type of casing as the hall doorway, but it is not original. It was created out of an original window sometime between 1903 and 1912. The photographic evidence for this is discussed in Mongin's report, on page 76. Apparently, the original window casing was reused in situ as the new door's casing: the window's sill, stool, and apron were removed, but the notches where the latter two were framed into the casing remain. The transom light would have been necessary, because first-floor Grange window openings extend much higher up the wall than do doorway openings. The transom light would have bridged the gap between the top of the regular-size door and the top of the original window opening. The fanlight in the transom appears to have been loosely modeled after the elaborate leaded transom light of the front door. However, the wooden "muntins" here are simply applied to the exterior surface of a single, large sheet of glass, rather than used to join together smaller pieces of glass.

The door within this doorway is stylistically similar to the original ones found elsewhere in the Grange, but it is constructed with wire nails, and so dates from the time the doorway was cut through. It is also smaller than the original doors.

Windows. The casing of the windows is the same relatively plain "simpler Type D" casing used around the doorways of this room. However, this casing is made to look fairly formal by the use of the "panel" arrangement found in the already-described southeast room. It was the existence of this floor-length window treatment that made it possible for the original west-window casing to be retained for the c.-1909 doorway. The two north-wall windows and their sash all seem to be original and unaltered.

Fireplace. There is no fireplace in this room today. Its south wall abuts the westernmost active chimney stack, however, and the idea that there had been a fireplace here originally was proven to be true by North Atlantic Historic Preservation Center staffers in 1977. Under the later flooring, and framed neatly into the older flooring, is a soapstone hearth. It seems most plausible that the fireplace relating to this hearth was closed up in 1933, when the new coal-fired boiler in the basement was vented through this flue. The new, narrower floorboards were then laid over the hearth, to conceal it. (See also Section A, "Fireplaces and Mantels.")

North Hall

This room was built to serve the original rear doorway, seen in the old photographs but closed up in 1889. Like the original front entry hall, it is pentagonal in shape, due to a triangular "apse" at its south end that is separated from the rest of the hall by an arched doorway.

Ceiling and Walls. These surfaces appear to consist mostly of original lath and plaster, and are in good condition. Nonhistoric plaster is found in the north wall, beneath the window, where the original rear door was closed up.

Cornices and Baseboard. The plaster cornice in the main part of the hall and the one in the apse are similar but not identical; both appear to be original (see Appendix M). The picture molding beneath the former was added while the Grange was owned by St. Luke's Church.

Like the cornices, the baseboards in the north hall and north apse are similar but not identical. The hall has the original "Type C" baseboard used in the adjacent northeast room. The apse has the "fancier Type D" baseboard used nowhere else in the house, but which is also deemed original because of its protected location and appropriate profile. The north wall of the hall has an 1889 baseboard section between two original pieces, revealing the location of the original, closed-up rear door.

Floor. The floorboards in this room match the narrow boards found in the adjacent northwest room; they, too, run north-south. Therefore, it is thought they date from 1933, and that they overlay original floorboards, also.

Doorways. The casings of all four rectangular doorways exhibit the same molding profile -- the simpler version of the "Type D" casing mentioned in Appendix M. This is the profile used in the adjacent northwest room, and in several of the rooms upstairs. The doors relating to these doorways are discussed in the sections on the rooms into which they open. The arched doorway between the main part of the hall and the apse evinces an original unornamented casing that is recorded in Appendix G, Sheet 11, and Appendix H, Sheets 30 and 31. The original rear doorway has been converted into a window.

Windows. The window in the north wall of the north hall was created out of the original rear-door opening. Considering the difference in heights between door and window openings (Ill. 54), this conversion would have been easier if the original rear door had had a transom light above it. However, the old photographs disprove this idea. Therefore, it seems that the original door opening would have had to be extended upward, in addition to being filled in at the bottom. This is borne out by an examination of the casing. It is secured with wire nails, which means that it was put up in 1889. However, it is the "fancier Type C" casing found in the study and second-floor north rooms (albeit used here without the panel underneath that usually accompanies this particular casing). This must have been the casing of the original rear door: no window casing was removed in 1889. And although it is considerably more ornate than the original casing of the other four doors of the north hall, there is a logical explanation. This doorway would have been visible from the octagon rooms, and therefore might have been accorded a better casing than the other doors, which were less visible.

Former Lavatory. Sketched plans of the house from 1925 show a small toilet room near the window in this hall (Ills. 72, 73). Slight cuts in both door casings on either side of the hall, and cuts in the baseboard that was installed after the door was removed, suggest that there might have been a tiny cubicle here. No other evidence exists. The appraisal after the 1933 restoration lists only two baths -- presumably the one on the second floor, and that in the basement.

Northeast Room

This room was designed as one of the more handsome in the house. There is no documentary evidence as to its original function. As mentioned in the section on the northwest room that is across the hall from this room, there is a good chance it may have been one of the Hamiltons' bedrooms. It does not seem likely that it was used as a guest bedroom: one account left by an overnight visitor to the Hamiltons' says that he slept upstairs (Mongin, p. 47).

It seems probable that at some point the initially elegant northeast room was reduced to the role of pantry, however. Having food brought to the east octagon dining room from the rear kitchen via the front stair must have been terribly inconvenient. Townsend's 1886 account indicates that someone finally did something about it. The account reads in part, "Passing now into the dining room...one sees the methods by which the food was brought in from the servants' quarters...." This statement would indicate that once inside the dining room, one could see at least two methods by which food was delivered. The physical evidence — discussed in the appropriate sections that follow — suggests that these methods consisted of a door into the northeast room and a dumbwaiter there.

Ceiling and Walls. These appear to consist mostly of the original lath and plaster. The south wall evinces a number of stabilized settlement cracks. The unoriginal portion consists of a closed-up doorway west of the fireplace (see "Doorways" below).

Cornice and Baseboard. There is no cornice in this room, and — like the northwest room across the hall — it seems to never have had one. It does have the picture molding installed by the congregation of St. Luke's Church. The baseboard is the original, "fancier Type C" molding used in the second-floor's center hall and north rooms.

Floor. The floorboards here are the same medium-width floorboards (five to six inches) that originally were installed throughout the Grange's first floor. However, they are marred by an infill patch in the corner to the right of the fireplace — outlining an area too small for a stair, but adequate for a dumbwaiter.

Doorways. The doorway to the rear hall is cased with the "fancier Type A" molding used in the east octagon room. The door that hung here is stored on the second floor of the Grange; it is labeled "Extra Door #1," and appears to retain its original mortise lock and escutcheons.

The idea that a second door, leading to the east octagon dining room, existed in this room was established by the 1964 Judd-Bevin investigation. It found — inside the south wall — the framing of a closed-up door just west of the fireplace.

It seems unlikely that this door would have been original. First, it would have marred the east octagon room's symmetry — a most important Federal aesthetic. And, if the room in fact was used as a bedroom, a door to the dining room would have been undesirable. More plausible is the thought that the door was cut through at the time the hypothesized dumbwaiter was installed. The location of the former door is in the same corner as the infill patch, and it seems likely that food delivered by the dumbwaiter would have been carried through the new door into the dining room.

The door — and the dumbwaiter, if its existence can be proven — probably was created during the residency of the William G. Ward family (1845-1876), which occupied the Grange as a home longer than any other post-Hamilton owner of the Grange. The question of when the doorway was closed up again could perhaps be determined by further physical investigation.

Windows. The window treatment in this room combines the "fancier Type A" casing with the panel arrangement found in the southeast and northwest rooms, yielding a very decorative effect. The sash are all original.

Fireplace. The fact that the mantel here is the same type of marble mantel found in the octagon rooms, suggests that the original wooden mantel here was ornate enough to be taken away by the elder William DeForest c. 1885.

The 1964 Judd-Bevin investigation delved deeply into this room's fireplace — the only one so treated. Most of the marble mantel was removed (Pl. 23), which exposed scored, original brown plaster. And a cast-iron fireback was discovered, as specified for this room by John McComb, Jr.

D. Room-by-Room Analysis: Second Floor.

The second floor of the Grange is depicted in Illustration 95.

Southwest Room

This room was created in 1889 in the upper part of the original stairwell, which was left empty when the main stair was moved eastward to the center of the south side. The physical evidence for this is cited in the appropriate sections that follow.

Ceiling and Walls. All of these surfaces -- except for the east wall -- seem to consist of the original lath and plaster, judging by the scars of original features found in these surfaces. On the ceiling, several feet out from the west wall, is the ghost of the partition that originally formed a closet along this wall, adjacent to the original stairwell. And on the south wall, in the southeast corner of the room, is the remains of the stair-balustrade extension (Ill. 91) that edged the original stairwell (see Section C, "Entry and Stair Halls, Original Form"). This balustrade section was taken down, and the present east wall constructed in its place, in 1889.

Cornice and Baseboard. There is no cornice in this room. The picture molding encircles the entire room and is fastened with wire nails, confirming the fact that it was added by St. Luke's Church after the move. The closet undoubtedly did not have a cornice originally. The upper part of the stair hall probably did not have one, either, based on McComb's proposal that limited cornices to first-floor rooms.

The baseboard was installed in 1889, according to two pieces of evidence: it rims the entire room without cuts and infills, and it is the same "simpler Type G" baseboard used on the south wall of the present stair hall, where the front door was closed up in 1889.

Floor. The largest portion of the flooring of this room was installed in 1889 to span the original stairwell. The five to six-inch floorboards are secured with large cut nails, and they overlay relatively small joists with sawn lath between them, holding the plaster of the ceiling below. A few original boards from the section of flooring taken up for the new stairwell seem to have been reused here, but most of the infill boards date from 1889.

A strip of flooring along the west wall is original, representing the floor of the original closet here. The boards of this section are fastened with wrought nails; they overlay large joists with split lath between them. Illustration 89 shows the 1889 boards in the foreground and the original ones at the rear; the closet partition would have followed the line between the two sections. Illustration 90 depicts the eastern edge of the 1889 infill flooring, which extends almost to the present east wall of the room.

Doorways. This room has two doors, one to the front hall and one to the west center room. The doorway to the front hall is part of the 1889 east wall, and so is not original. Its room-side casing displays a non-Federal molding profile, and it is secured with large, late cut nails having squared heads and blunt points (ill. 96). The door here represents a real enigma. It is discussed in the next section, "Front Hall," because it seems to relate to the hall-side casing of the doorway.

The doorway to the west center room is an original one, built for access into the original west-wall closet. Its casing is narrower than standard Grange casings: it has a quirked ogee molding but only one fascia on its face, whereas most of the original casings have two. There is no question but that it is original, however, because it is secured with wrought nails (ill. 97, center). If this molding was originally inside the west-wall closet — which is thought to be the case — this choice of scale seems most appropriate. It has been assigned the label of "simplest Type C." The door here seems to be original, but it features a late 19th-century, cast-iron mortise lock.

Windows. The west and south windows' casings do not match. That of the west window is the same original, "simplest Type C" casing found around the doorway to the west center room. This is understandable, since both elements were within the original west-wall closet. The south window, which was not in the closet but in the original second-floor stair hall, has a different casing. The east and top members of the casing have a profile that is similar to the "fancier Type D" casing used throughout the second floor (see Appendix M). However, its two fasciae are less than standard width. The west casing member of the window has the same two compressed fasciae, but with a unique edge molding.

Based upon this information, it would seem that the "simplest Type D" casing found on the east and top sides of the west window was that used in the original stair hall. The compressed fasciae might be explained by the fact that this casing was designed for a window, or else by the fact that it was located at second-floor level. The west member is much the same as the east and top members, and probably was installed when they were. This member's position — right up against the original closet partition — may have made it impossible for an edge piece to have been installed at the time of construction. The edge piece here today probably dates from 1889, when the partition was removed; a check of the nails fastening it could confirm this.

This line of thinking would mean that the interior of the original closet here had moldings more ornate ("simplest Type C") than did the original stair hall ("simplest Type D"). However, the closet served the fairly important west center room, and it may have been designed to relate to this space.

Front Hall

This area was changed extensively in 1889, when the new stairwell was cut through the flooring along the east and south walls.

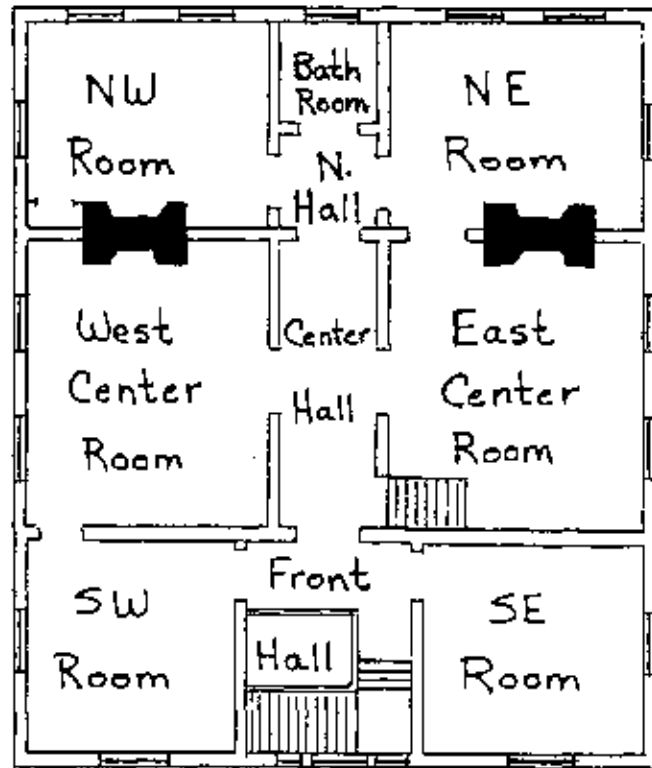

Illustration 95. The Grange: Plan of Present Second Floor.



Illustration 96. The Grange: Second-Floor Southwest Room, X-Ray through Frame and Casing of Hall Doorway (1977).

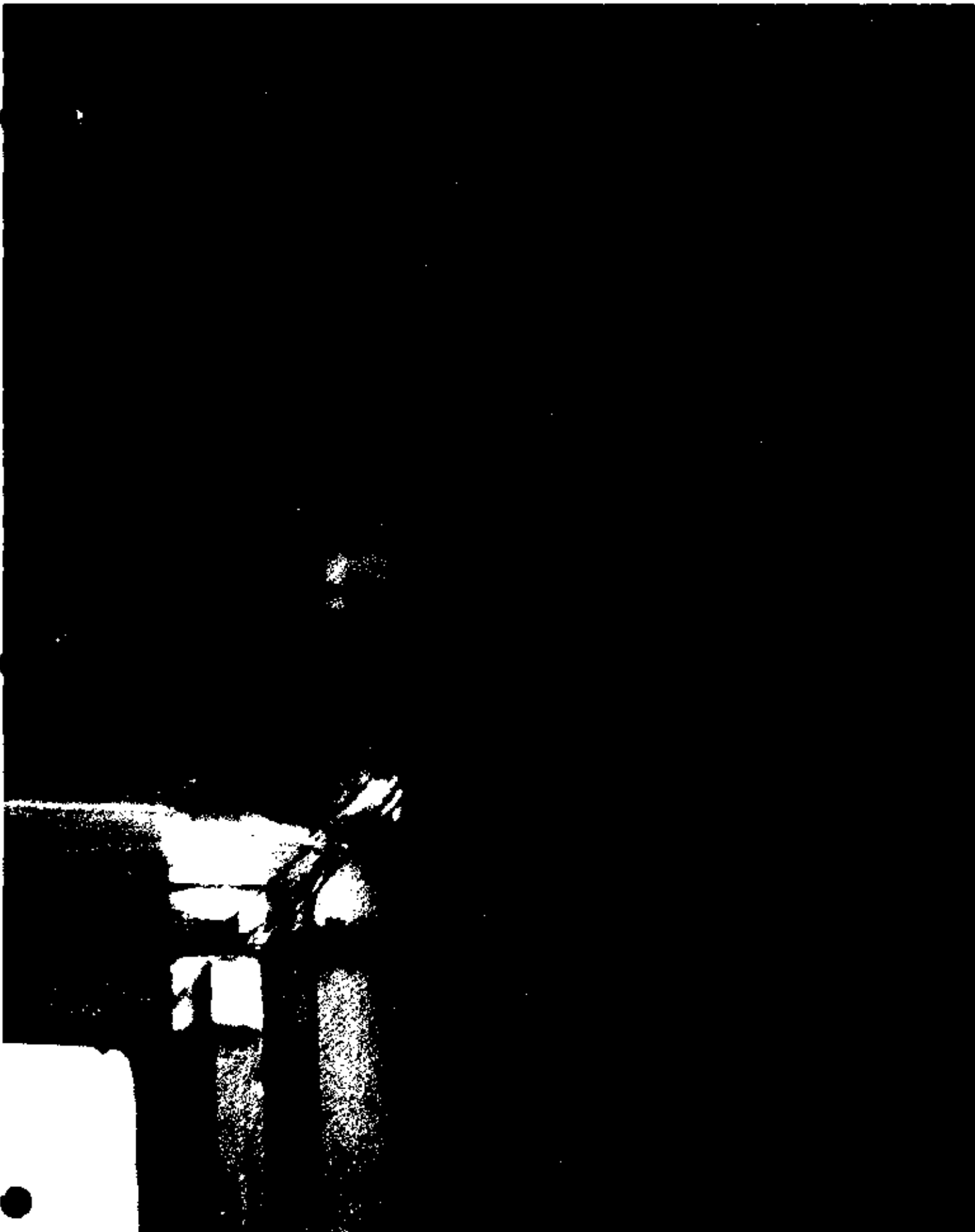

Illustration 97. The Grange: Second-Floor Southwest Room, X-Ray through Casing of Doorway to West Center Room (1977).

Ceiling and Walls. The ceiling seems to be of the original lath and plaster. The west wall is of c.-1889 lath and plaster, as mentioned in the discussion of the southwest room. The north wall and its arched doorway leading to the center hall are original. The east wall is mostly original, but it incorporates at least one c.-1889 infill patch (see "Doorways," below). The south window with its tripartite window is original.

Cornice and Baseboard. There is no cornice, nor any evidence that there was one here historically. The picture molding is that put up by St. Luke's Church. The baseboard on the north wall is the original, common "Type C" molding. Presumably, pieces of this trim would have edged the east and south walls, too, before the 1889 stairwell was created. (These pieces seem to have been saved in 1889 and reused, in the southeast and east center rooms on this floor.) There is no baseboard on the west wall. There would not have been any baseboard here originally, because this wall was then a balustrade. However, it seems strange that when the wall was built in 1889, it did not receive any baseboard molding; this is the only area in the house so treated.

Floor. The floorboards here are a part of the original floor of this room; the remainder were removed when the new stairwell was cut through in 1889. They are the narrower boards used throughout the first floor of the Grange; apparently, this second-floor area was deemed important enough to receive the fancier type of flooring used downstairs. However, the boards are surfaced-nailed, rather than blind-nailed like the boards downstairs.

Doorways. The doorway in the west wall, as mentioned in the discussion of the southwest room, is nonhistoric. However, it is rimmed on this side with an original, reused casing: Illustration 96 shows the c.-1889 nails currently attaching it, but also shows — at left — bent-down wrought nails. The form of this casing resembles that found around the east and top sides of the south window in the southwest room. Its two fasciae are not compressed, but the likeness is strong enough to consider this a "simplest Type D" casing, too. This suggests that the casing was brought here in 1889 from some original location related to the aforementioned window. Scars of a lock on the casing's north member do not relate to its present location, and so must date from the original location.

The door appears to be the only original Grange door paneled on one side only. Today, it hangs by its north stile; the arrangement of its original-type mortise lock requires that it swing toward the unpaneled side. However, hinge scars on the door's south stile indicate that it once hung by this edge. If the mortise lock present today was present then, it would have had to be on the opposite side of the door, and the door would have swung toward the paneled side.

This arrangement would account for the lock scars on the north member of the casing. There is a chance that the casing and the door being discussed here were not used together originally. However, the lock-scar evidence is one indication that they were.

With this information in hand, possible specific locations for the casing and door can be considered. Three interior doorways were abolished (excluding those in the cellar) in 1889: the original attic-stair doorway, the original entry hall-stair hall doorway, and the original, first-floor stair hall-closet doorway. Based upon its "simplest Type D" profile, the casing probably came from the first-floor stair hall. This would best explain its resemblance to the second-floor southwest room's window casing, as well as its wider, uncompressed fasciae. The door's unpaneled side rules out its use in the entry hall-stair hall doorway: both of these areas were too formal to have such a door. So, if the casing and door were used together originally, they probably came from the original stair hall-closet doorway.

The arched doorway in the north hall is original, and its details are recorded in Appendix G, sheet 12, and Appendix H, sheets 32-33. The doorway in the east wall is original. It is trimmed with the "simpler Type D" casing. Its door is discussed in the section on the southeast room, into which it opens.

Another doorway used to exist in the south end of the east wall, as mentioned in this room's "Ceiling and Walls" section and seen at right in Illustration 98. This was uncovered during the 1964 Judd-Bevin investigation; it had been walled up in 1889 when the floor in front of it was removed to make the new stairwell. This doorway is discussed more fully in the section on the southeast room.

Window. The tripartite window in the south elevation was an important feature aesthetically, but it also served to flood the main stair with natural light, even when the stair was in its original position west of the window. (See Section C, "Entry and Stair Halls, Original Form.") Almost all of this window's present elements are original ones. The sole exception is the apron molding under the window stool, which has a c.-1889 profile. It seems that the tripartite window's enframing extended down to the floor of the original second-floor front hall, such that no apron -- or else a very narrow apron -- was used. When the floor in this area was removed to make the stairwell in 1889, a larger molding was applied.

The form of the tripartite window is depicted in Appendix F, sheet 10; Appendix G, sheets 4 and 8; and Appendix H, sheets 13-15.

Stair. The present stair has been described in Section C, "Entry and Stair Halls, Stair."

Southeast Room

This room has undergone changes, but its original character is still apparent. The simple lines of all of the individual elements here reinforce the impression that this was not designed as a formal room.

Ceiling and Walls. The ceiling and walls here are believed to be mostly original. (The closed-up doorway in the south end of the west wall — Illustration 98, right — has already been noted.) The ceiling bears a partition ghost, about three feet east of the west wall, starting at the south wall and ending at a point in line with the south jamb of the present, original, hall doorway. The 1964 Judd-Bevin investigation determined -- with the aid of other information — that this partition enclosed the original attic stair, which was reached from the southeast corner of the front hall (now in the stairwell) via the closed-up door.

Cornice and Baseboard. The only cornice-type trim in this room is the later picture molding. McComb's proposal and the general simplicity of the room suggest that there was no cornice here originally. The baseboard consists of several different sections, which have helped researchers understand the changes that occurred here. The baseboard on the north and east walls is the "simpler Type D" molding, used also in the study and second-floor center rooms. This is found on most of the south wall as well. However, at the western end — which would have sat within the original attic-stair compartment — there is a short length of the original "Type C" baseboard used in the center hall. This is too ornate to have been in this simple room initially; it most likely was left over from remodeling the original front hall and reused.

The west wall, which would have been entirely inside the attic-stair compartment, bears no such original, reused baseboard section. There is a length of c.-1889 molding ("simpler Type G") running from the south wall, and no baseboard at all from there to the hall door. These facts would suggest that the original attic-stair compartment had no baseboard.

Floor. The original floorboards found here measure 10 to 12 inches in width; they are surface-nailed, rather than blind-nailed, as explained in Section A, "Floors." There are no infill patches in this floor, but a worn spot exists in the northeast corner (see "Closets," below).

Doorways. The hall doorway is original. Its casing is the "simpler Type C" molding. (This is used nowhere else in the house except in this room, but it is of an appropriate form and mostly undisturbed.) The top member of the room-side casing is poorly patched: it apparently was designed to accommodate the soffit of the original attic stair that passed above it, and had to be patched when the stair was removed.

The original door here is paneled on both sides. However, "dutchmen" and hinge scars on its south stile suggest that the door originally swung in a direction opposite to that seen now. The change probably occurred when the original attic stair was moved out of this room. With the stair compartment gone, the door — when open — would have taken up valuable space along the west wall. It would have been more convenient for it to hang against the north wall. Therefore, it may well have been rehung at this time. In any case, it seems to have been done after 1850: the rim lock

now on the door dates from the mid-19th century, and it shows signs of having been modified to accommodate the rehanging. (It was moved to the opposite side of the door and attached upside down, in order to get it to engage the north jamb.)

It is possible that a doorway led from this room into the original attic-stair compartment; it would have been directly opposite the door from the front hall into the compartment. Newton Bevin includes such a doorway in his Restoration Drawings (Appendix J, Sheet 3). If this secondary doorway had been in existence in 1889, the attic-stair compartment would not have had to be moved when its main door was closed up. There is thus a chance that the attic stair was moved after the 1889 remodeling — according to the physical evidence, as much as 10 years afterwards. However, since the stair did have to be moved sometime, it would seem that the secondary door did not, in fact, ever exist.

Windows. The casings around the windows are the same "simpler Type C" moldings used around the doorway to the hall. The sash of the south window are original, but the sash of the east window are 1978-1979 reproductions installed in place of c.-1960 sash that replaced the deteriorated original sash. (See Chapter II, Section H, "Sash," and Chapter IV, Section B, "Individual Rooms.")

Closets. The worn area in the floor in the northeast corner indicates that a corner closet once existed here. Two c.-1925 plans of the second floor (Pl. 72, 73) show such a closet. It is not known if it was original. Presumably it was removed during the 1933 restoration, and it seems unlikely that the restorers would have disposed of obviously original material. The basement cupboard may be this closet.

Newton Bevin postulates in his Restoration Drawings (Appendix J, Sheet 3) a second closet, beneath the original attic stair. Before the hall door was rehung c. 1889, it would have blocked access to such a closet when open. This also would mean that this lowly room had two closets — a luxury not found anywhere else in the Grange. Unless additional evidence for this below-stairs closet turns up, its existence seems unlikely.

Center Hall

This room remains as constructed, with the addition of the attic-stair doorway cut through its east wall in 1889, when that stair was relocated from the southwest corner of the southeast room to the southwest corner of the east center room.

Ceiling and Walls. These seem original and in good condition.

Cornice and Baseboard. The only cornice molding here is the ubiquitous later picture molding. There probably was no cornice here historically. The baseboard is the original "Type C" molding used in the north rooms on this floor. It contains no infill sections, but a piece of original material was removed when the attic-stair doorway was cut through.

Floor. The 11- to 13-inch wide, surface-nailed floorboards appear to be of the original type used extensively on the second floor of the Grange.



Illustration 98. The Grange: Second-Floor Southeast Room, Plaster Scars and Framing Evidence of Original Attic-Stair Compartment and its Doorway (1964).



Illustration 99. The Grange: Attic, Framing Evidence of Original Attic Stair (1964).

Doorways. The original archway to the present stair hall has been described in the section on that space. The original rectangular doorways to the center rooms and the north hall are rimmed with the "simpler Type D" casing found in the second floor's center rooms and original front hall. The doors of these doorways are discussed in the sections on the rooms into which they open.

The doorway to the attic stair has a casing very similar to that used around original doorways in this area, but the main ovolo in its edge molding is an unvarying eighth of an inch wider than that in the original molding type. This suggests that it dates from the 1889 renovation, when this doorway was probably cut through. The door here can be assigned the same date, on the basis of its panel-molding profile and undisturbed cast-iron lock.

West Center Room

This is a handsome room that has seen relatively little change. Its architectural elements include both sophisticated and modest features, probably for reasons of economy.

Ceiling and Walls. These appear to be of the original lath and plaster. (See Section A, "Lath and Plasterwork.") The north wall exhibits numerous settlement cracks.

Cornice and Baseboard. As per McComb's proposal, there seems to have been no original cornice here. The present picture molding is that from 1889. The baseboard is mostly original, being the "simpler Type D" found also in the second-floor southeast room and downstairs study.

Floor. The floor is original and mostly intact, although well-worn. It consists of the less-elegant, 11- to 13-inch boards running east-west. However, these are blind-nailed with large wrought-iron flooring nails, as are the narrower board downstairs, to achieve at least a little formality. The joists, lath and plaster, and "deadening" under the floor are identical to those under the original floors described in Section A. Inactive gas pipes run east-west under one of the floorboards in the center of the room.

Doorways. The two doorways in this room seem to be original; they lead to the center hall and to the southwest room (i.e., to the former, original, west-wall closet next to the stairwell). The casings here are the "simpler Type D" moldings found around the doorways in the adjacent center hall. Both doorways have their original doors; that to the hall bears its original steel mortise lock, while that to the southwest room has a late 19th-century, cast-iron rim lock.

Windows. Like the floor in this room, the windows evince an informal/formal treatment also found in the first-floor northwest room. Their casing is the relatively plain "simpler Type D," but they have the panel beneath them to provide a more formal feeling. The sash all seem to be original.

Fireplace. The fireplace here features an original wooden mantel (Ill. 19) that represents the basic Grange mantel (see Section A, "Fireplaces"). A coal grate has been added; this probably was done prior to the advent of central heating in the Grange in 1933.

Closet. The sketches of the Grange's first- and second-floor plans made 1925-1930 (Pls. 72, 73) show a closet in this room, in the recess west of the fireplace. No physical evidence has been found to confirm this. If such a closet did exist, it would have sat back-to-back with a similar closet in the northwest room on this floor. The latter was a c.-1889 addition, and it seems likely that any closet here would have been the same.

East Center Room

This space initially was very similar to the west center room, but a number of changes have altered original fabric. The most notable of these changes was the installation, in the southwest corner, of the 1889 attic stair. This is described more fully in the "Attic Stair" section below.

Ceiling and Walls. All of the original lath and plaster remains here, but the north wall displays severe settlement cracks.

Cornice and Baseboard. The only cornice is the picture molding; no evidence was found for any earlier cornice molding. Most of the baseboard is the "simpler Type D" style found in the companion west center room. The baseboard outlining the attic-stair compartment in the southwest corner is the original "Type C" molding found in the center hall. These sections must have been taken out of the original front hall in 1889, from the east and south walls where the stairwell was cut through. There is no baseboard inside the closet. The "simpler Type D" trim here originally must have been removed when the compartment was built. Why this baseboard was not reinstalled on the outside of the compartment is not clear; it may have been a little too short to have been reused.

Floor. The flooring here is the same original, composite type used in the west center room -- 11- to 13-inch boards that are blind-nailed. They overlay the same original type of joists, fireproofing and lath and plaster found in the other room.

Doorways. The doorway to the center hall is original, and it displays the same "simpler Type D" casing found in the west center room. The door here appears to be original. Its signed, cast-iron mortise lock bears a mid 19th-century date (see Appendix N). There are scars below this lock of an earlier one, which presumably would have been a steel-case mortise lock like the one on the door across the hall.

The doorway to the northeast room, west of the fireplace, is not original. Judging by the style of its casings and the door's panel moldings, it was cut through in the mid-19th century. (See Appendix M.) Interestingly, this doorway is directly over the doorway that was cut through between the east octagon and northeast rooms on the first floor, but later closed up. It seems likely that both of these doorways were created at the same time. The mid 19th-century styling of the extant door's panel moldings adds weight to the idea that the Ward family (1845-1876) installed them. The cast-iron mortise lock is also from about that time.

The doorway to the closet that is built into the 1889 attic-stair compartment, of course, dates to 1889. The top and north members of its casing, however, have the "simpler Type D" profile found elsewhere in the room. They thus seem to have been reused. They probably came from the original attic-stair doorway in the original second-floor front hall, which also had this type of casing. The south member of the casing — partially buried in the wall — appears to be an 1889 addition. The door here does not seem to be original. It has six panels, but the two small panels are in the center of the door, indicating a c.-1889 date. Also, it is not mortised, and it has a late 19th-century, cast-iron rim lock.

Windows. The window casings in this room represent an anomaly. The casings of the south window — like those of the hall door — have the original "simpler Type D" profile. The north window's casing has the same face, but its edge molding is wider and unlike any other in the house (see Appendix M). Physical investigation shows it to be secured with wire nails. Beneath the edge molding is a paint line and the remains of cut nails — indicating that a narrower, standard edging was installed here originally, and that it was replaced sometime after 1890 with a wider piece. Both windows have the panels beneath them; their sash are 1978-1979 reproductions.

Fireplace. The original wooden mantel here is identical to that in the west center room (Ill. 19). There is no coal grate.

Attic Stair. The present attic-stair compartment sits in the southwest corner of the room, along the south wall. One cannot gain the stair from this room; the door to it is located in the southeast corner of the center hall. As already mentioned, however, there is a closet in the east end of the compartment, below the ascending stair.

This has been the case since 1889, or shortly thereafter. In that year, the Grange was moved, which caused the main entrance to be relocated. This required the rebuilding of the main stair in the original second-floor front hall, which in turn required the closure of the doorway from that hall to the original attic-stair compartment. This seems to have prompted the creation of the present stair and compartment, in the east center room.

Some of the physical evidence for this has already been discussed. It includes the remains of the original compartment in the southeast room; the lengths of nonconforming baseboard in the southeast and east center rooms; and the c.-1889 style of the doorway into the present compartment. Even more graphic proof can be found in the attic, as seen in Illustration 99. The hole in the floor at the center of the photograph was part of the original stair, which ascended northward. The present attic-stair opening is seen in the foreground. This stair ascends westward. The change in direction of the stair might be attributable to the nature of its relocation site: because of the central position of the hall door in the east room, the new stair would not fit along the west wall, as it had done in the southeast room. It therefore would have had to be placed along the south wall.

North Rooms

The four second-floor north rooms consist of two corner rooms flanking a narrower space, which is divided by a partition to form a small hall and bathroom (Ill. 12). These four spaces were created before 1820, when the single large room originally here was subdivided via partitions. The evidence for this is cited below. The relatively elegant architectural details used here suggest that the large room was a fairly important one — perhaps a family living area. One possible reason for the subdivision, as mentioned earlier, was to increase the number of bedrooms available to the Hamilton children as they grew older.

Ceilings and Walls. The ceilings, outer walls, and walls shared within the center rooms are all of the original lath and plaster. They are in fair condition, with settlement cracks evident in southern walls. The inner partition walls seem to be of the same material (Ill. 100). This indicates that they were erected prior to the advent of sawn lath, which occurred about 1830.

Cornice and Baseboard. The corner rooms and the south wall of the little north hall feature a prominent plaster cornice. All of the physical evidence indicates that the majority of this cornice molding is original to the Grange. McComb's proposal does not include cornices for any second-floor rooms. It does include cornices for the first-floor north rooms, which seem to never have gotten them. It thus seems that Hamilton negotiated with McComb and "traded" the downstairs north rooms' cornices for one in the large, second-floor north room.

At first glance, all lengths of this cornice appear to be identical. However, close examination reveals that the sections on the inner partition walls — i.e., on the east wall of the northwest room, and the west wall of the northeast room — are slightly different. This is consonant with the idea that the partitions and their lengths of cornice were installed soon after the Grange was built. (See Appendix M.)

The cornice, in fact, provided the first clue that the majority of the partition walls here were not original. As seen in Illustration 101, the cornice of the corner rooms is also found on the south wall of the north hall, but not on its side walls. The 1964 Judd-Bevin investigation checked into this, and found that the south-wall cornice continues unbroken under the north-south partitions (Ill. 14) from one side of the house to the other. This proved that the partitions were added after the original construction period. However, the parts of the cornice covered by the partitions had very little paint upon them, which indicated that the north-south partitions were introduced not long after the Grange was built.

The baseboard on the original walls and partitions is the original "Type C" molding found in the center hall and first-floor northeast room. The baseboard on the later partitions resembles this, but differs slightly.

Floors. The floorboards in all four rooms are the same original ones found in the adjacent center rooms: wide (11- to 13-inch) boards that were blind-nailed to achieve some measure of formality. These boards pass beneath the inner partitions, confirming the idea that these were added later.

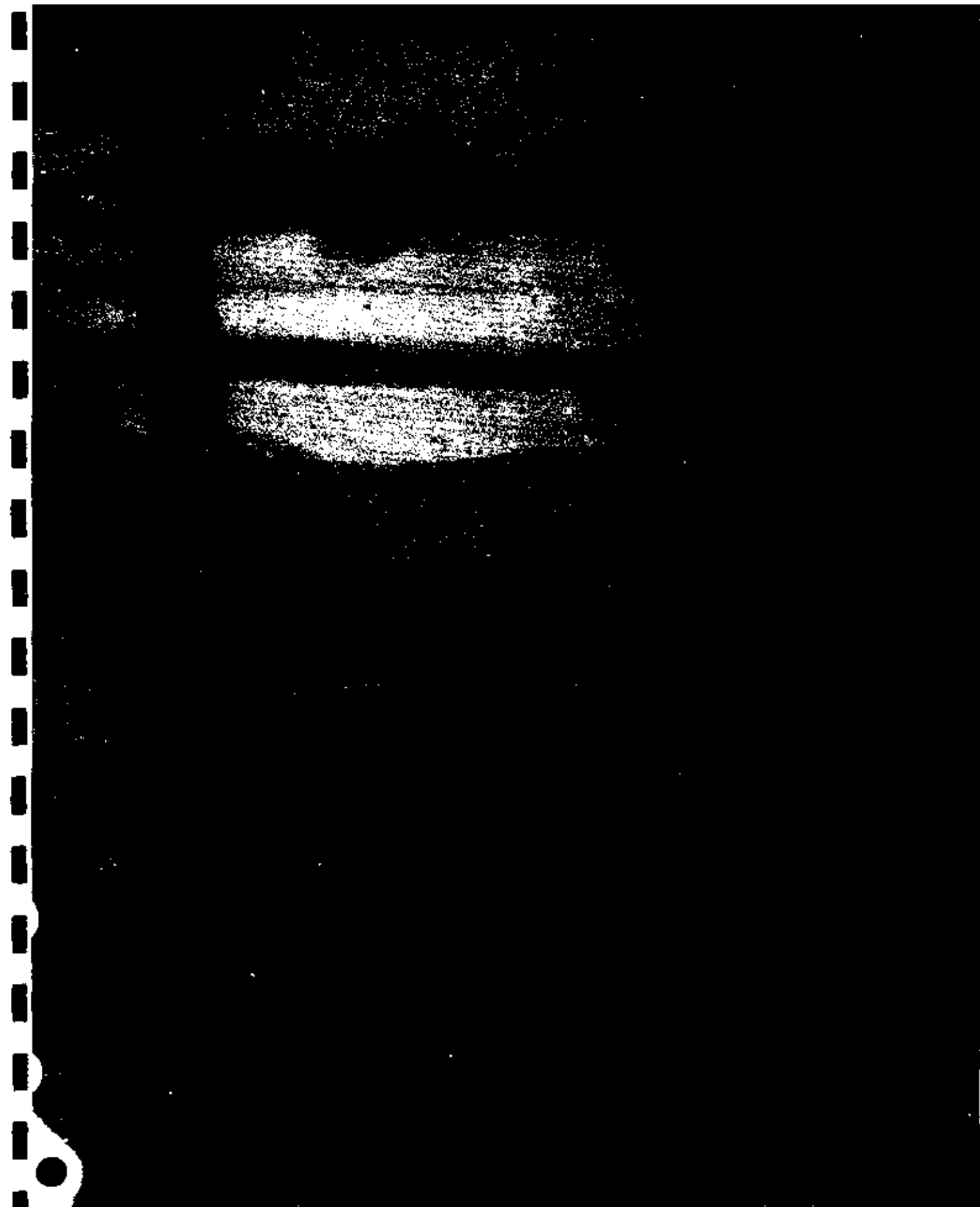

Illustration 100. The Grange: Second-Floor Northwest Room, X-Ray through 1810-1820 Partition Wall (1977).

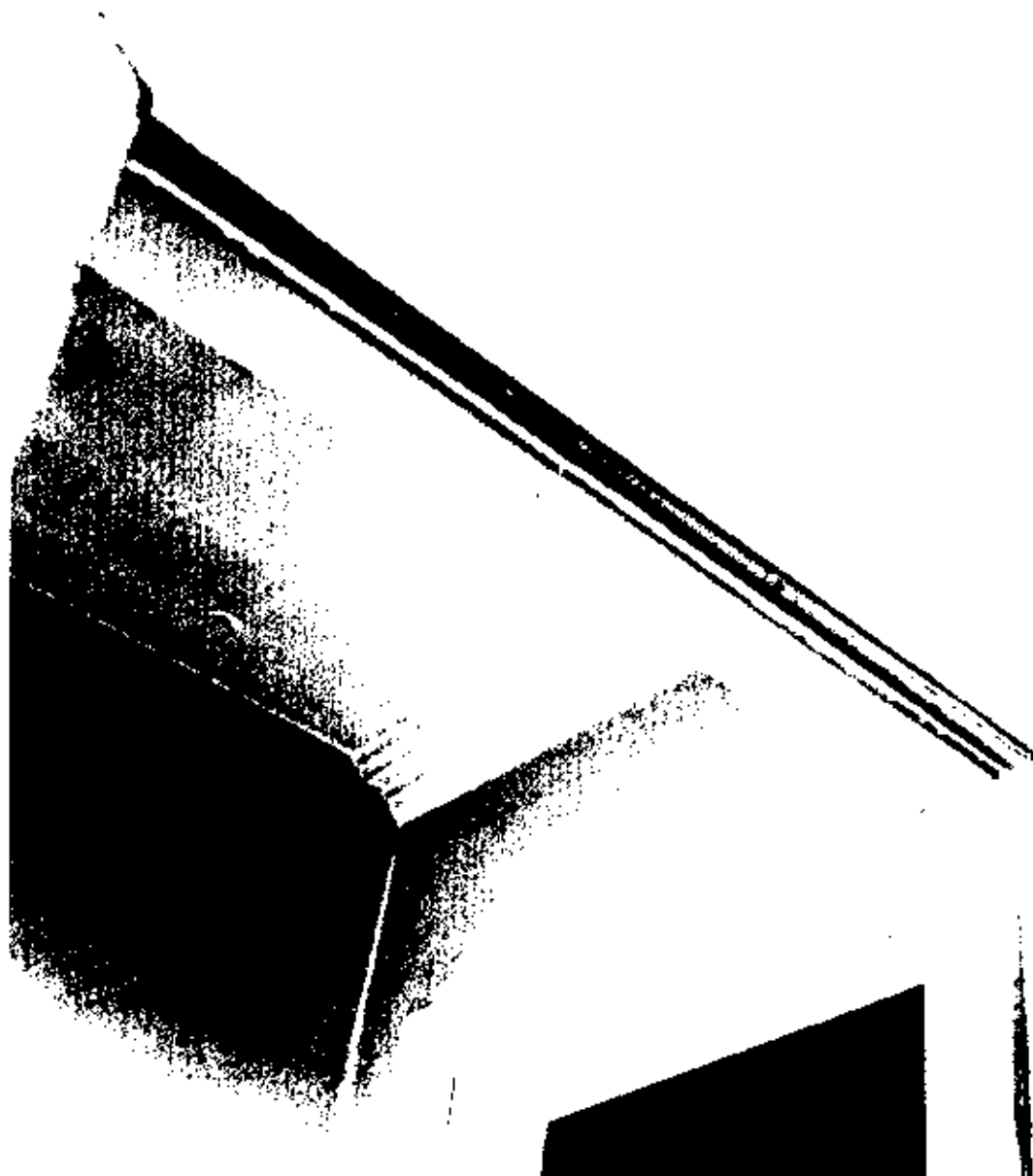

Illustration 101. The Grange: Second-Floor Northwest Room and North Hall, Original and Continuous Cornice on South Wall (1964).

Doorways. The only original doorway in this entire area is the one leading from the center hall into the north hall. This was the original entrance into the large north room. Its casing is the "fancier Type C" style found around the windows of the three north rooms; it is secured with wrought nails (Ill.102). This doorway does not have a door now, but hinge scars on its west jamb indicate that a door did once hang here. This door does not appear to have been saved, perhaps because it became unnecessary so early in the Grange's history. It probably had a steel mortise lock, like the center hall's other doors did.

The doorways from the north hall into the corner rooms are within unoriginal partitions, and so are not original themselves. X-rays through their casings pinpoint the partition-installation date as being between 1810 and 1820. Illustration 103 shows both large wrought nails and smaller cut nails with machine-made heads. The former were seldom used to secure casings after 1820; the latter were available as early as 1810. (At least, the larger sizes of such nails were available in New York by that date, and presumably the smaller sizes would have been, too.)

The doors in the two unoriginal doorways are unoriginal. Their panel moldings are very similar to those of the original doors, however, which again indicates a very early date for the partitions' introduction. The door to the northeast room has what appears to be a very early iron rim lock. The iron rim lock on the door to the northwest room seems to be a late 19th-century replacement.

As mentioned, casing nails and the lack of paint on the covered sections of cornice date the north-south partitions to 1810-1820. The east-west partition here -- although part of the present bathroom -- seems to be equally as old. The hall-side casing and door of the doorway into the bathroom are identical to those used for doorways into the corner rooms. (The door bears a late 19th-century, replacement rim lock.) The bathroom-side casing of this doorway is simpler than that used on the hall side, but it is similar enough to be considered contemporaneous. Bathroom fixtures would not have filled this space in 1820, of course: its most probable use would have been as a closet.

The doorway and door leading from the northeast room to the east center room -- as indicated in the discussion of the latter space -- dates from the mid-19th century.

Windows. All of the window openings in the two corner rooms are original, judging by old photographs (Ill. 35). Their treatment is the same fairly ornate one found in the first-floor southeast study: the "fancier Type C" casing incorporating the panel beneath.

The bathroom window opening -- also original -- does not have a panel beneath it. It does have the same type of casing as the other windows in this area, though, and it was located in the original large room with these windows. Therefore, it seems probable that the bathroom window did have a panel originally. This may have been removed when the bathroom fixtures were introduced -- the window sill here seems to have been replaced.

All sash appear to be original, except for those of the window in the east wall of the northeast room. These latter are 1978-1979 reproductions, installed in lieu of less-correct replacement sash dating from c. 1960.

Fireplaces. The fireplaces in the corner rooms are original, and they feature identical c.-1802 wooden mantels (Ill. 20). These mantels are considered to be a somewhat ornate version of the "basic" Grange mantel found in the center rooms. In any case, enough attention was lavished on the north room's mantels to reinforce the idea that the large room was a fairly important one during Alexander Hamilton's years at the Grange.

Closets. The closet in the southwest corner of the northwest room is a later addition: its doorway casing, door-panel molding, and cast-iron lock suggest it was created in 1889. (The panel molding is the same as that of the present attic door, thought to be c. 1889.)

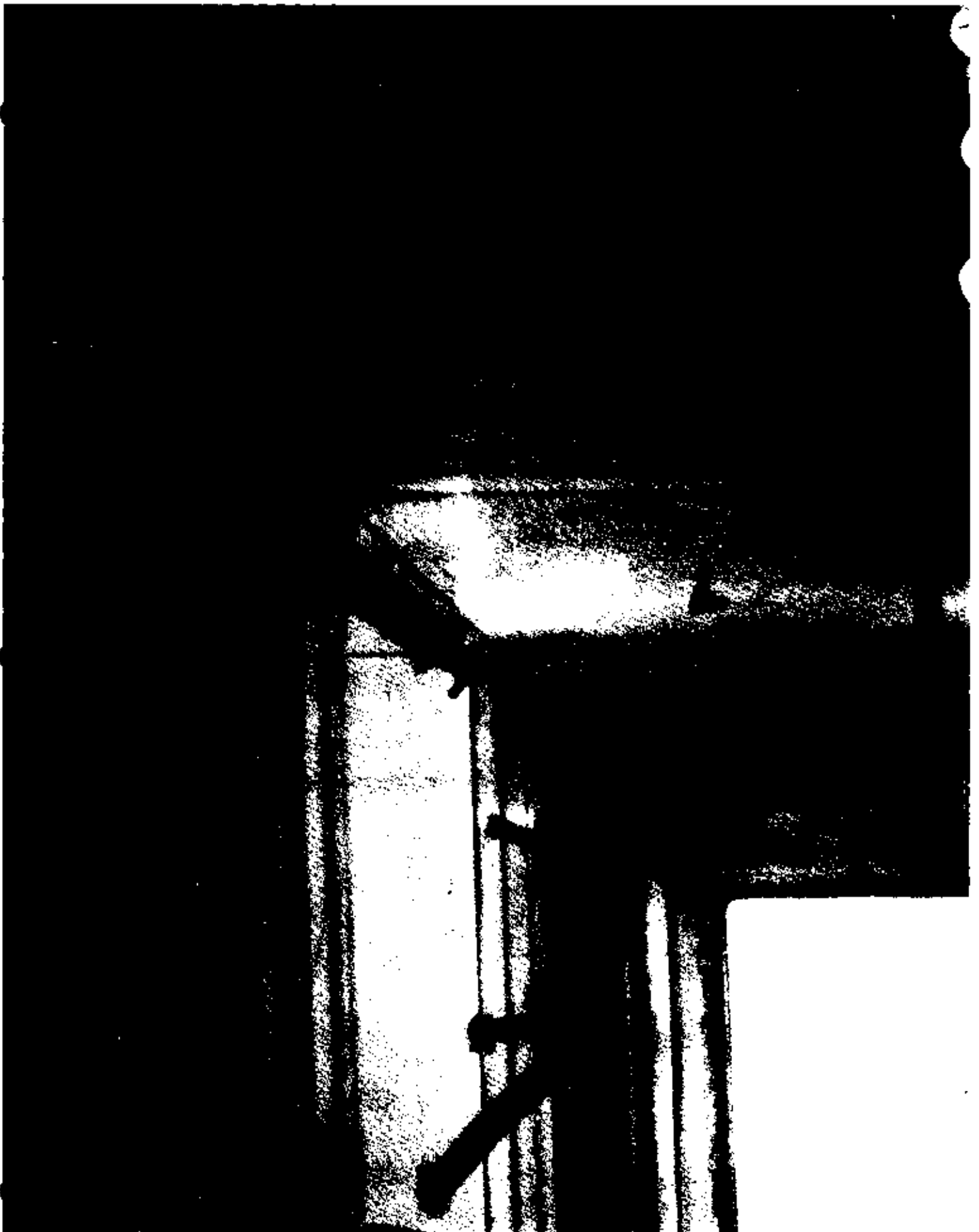

Illustration 102. The Grange: Second-Floor Center Hall, X-Ray through Casing of Original Doorway to North Rooms (1977).

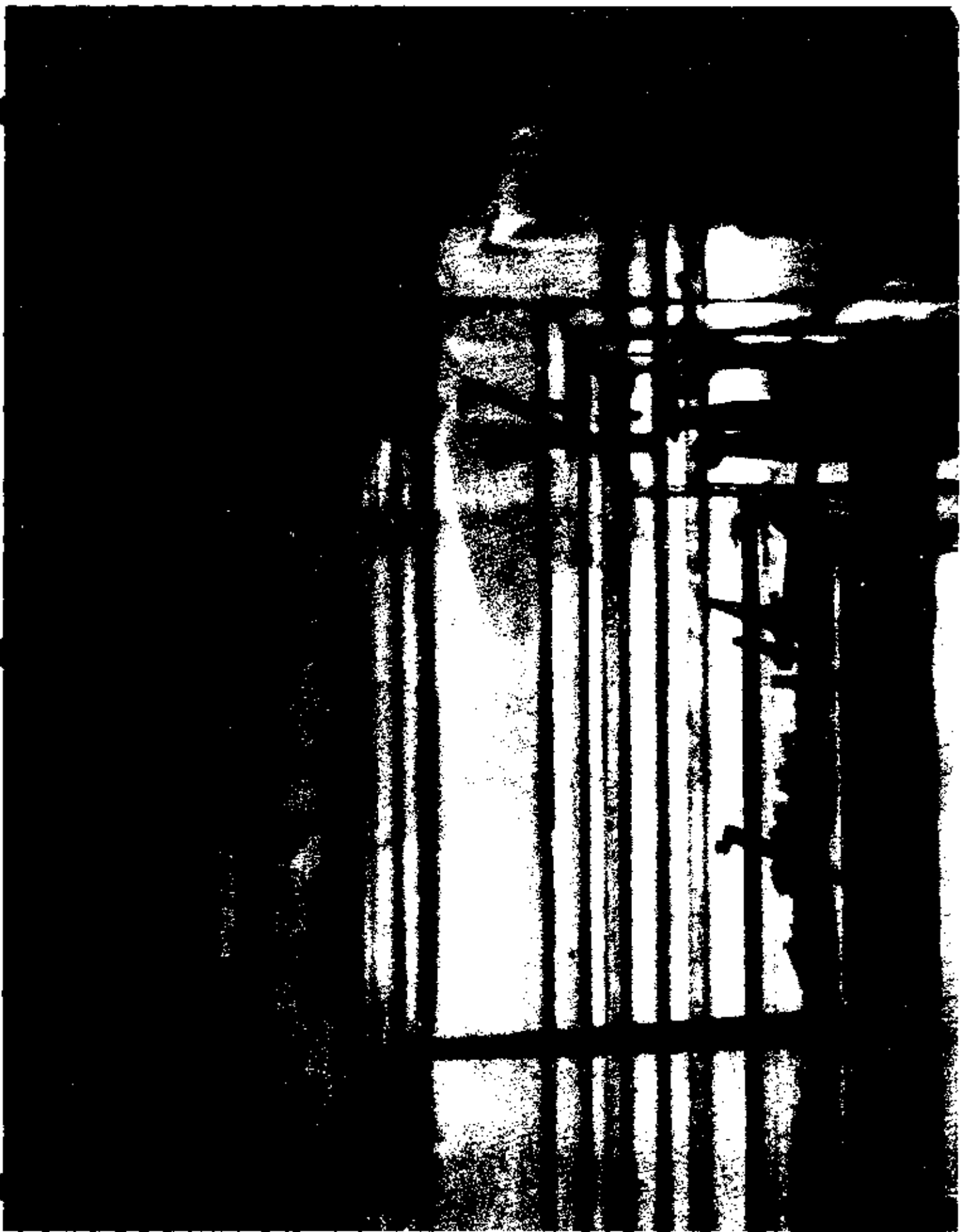

Illustration 103. The Grange: Second-Floor North Hall, X-Ray through Casing of 1810-1820 Doorway to Northeast Room (1977).

E. Attic Analysis

The upper roof-framing members are discussed in detail in Chapter II, Section B, "Main Roof, Framing" (p. 95). Each of the two continuous north-south timbers upon which this framing rests measures eight by 12 inches (Ill. 104, bottom). They bear upon the north and south wall plates and the interior, east-west bearing partitions. The five-foot posts that support the corners of the rectangular timber frame (Ill. 104, center) are not positioned precisely over the bearing partitions. Instead, they sit more toward the eaves, about one-quarter of the distance out from the eaves (Appendix J, Sheet 4). Additional five-foot posts support the east and west beams of the frame at their midpoints (Ill. 105, left).

The two north-south timbers are linked by one east-west timber lying south of the active, north chimney stacks (Ill. 106, foreground). It measures three by nine inches, and its ends are framed into the top surfaces of the north-south timbers.

Illustration 106 shows the effect of the settlement that took place from 1889 to 1967. At center is the corner post above the northern east-west bearing partition. As stated previously, this partition sank, because its underpinning in the basement sank, because the timber in the cellar that supported the underpinning failed. And when the partition sank, the north-south attic timber bearing upon it sank. However, the corner post did not sink. Its top end was connected so securely to the rest of the roof framing, that its bottom-end joint failed instead. The trunnel pinning the joint together broke, and the mortise dropped away from the tenon.

Mention has been made in Chapter II of the empty mortise holes in the east, west, and north members of the rectangular timber frame — remnants of an original flat roof deck. The east and west beams have one and two holes, respectively, in their inner surfaces. The north beam has five smaller holes in its inner side (Ill. 106, right). This arrangement suggests that the original roof deck consisted of east-west beams that carried five north-south joists. The south beam of the frame has no mortise holes, as stated. Although it exhibits "original" framing details, close examination shows it to have been cut with a vertical saw. (The timbers with the mortise holes have marks showing they were cut with an ax and adze.) It thus appears that the entire south timber is a replacement; it probably dates from the time of the main-roof raising, when mortise holes were no longer needed.

The only other attic framing of note is the two rows of wooden supports for the two false chimneys positioned just north of the two southern corner posts (Ill. 105, center rear).

A roof scuttle is located on the southern slope of the roof, on the raised portion (Appendix J, Sheet 5). It is approached by a short, nearly vertical ladder. The nails used on the casing of the scuttle and on the ladder indicate a date of mid-to-late 19th century. The raised roof probably would have had a scuttle, so the present scuttle seems to be a replacement, rather than an addition.

The stacks of the two operative, north chimneys pass through the attic adjacent to the northernmost corner posts of the timber frame. These retain most of their original mortar inside the stack, but their surfaces appear to have been reworked. Portions of timbers adjacent to the north chimney are slightly charred, probably the result of a small chimney fire at some time.

F. Mechanical Systems Analysis

Heating and Cooling

The Grange is heated by a gas-fired steam boiler installed in 1967. This boiler replaced a coal-fired one dating from 1933, when central heating was introduced into the Grange. The present radiators also were installed as part of that first system. [2]

Several of the fireplaces feature coal grates, which appear to be the product of a mid- to late-19th century attempt to deal with the lack of central heating. In the early 19th century, the Hamiltons must have depended solely upon the fireplaces for heat — although it must be remembered that the Grange was chiefly a summer residence.

There is no central air-conditioning system.

Water and Sewer

A 30-gallon hot-water heater, a kitchen sink, and three bathrooms constitute the Grange's current plumbing system. The relatively new hot-water heater is located in the cellar; the sink and two of the bathrooms are found in the basement; and the third bathroom sits between the two north corner rooms on the second floor.

The present kitchen area dates from 1914, when the basement was remodeled as living quarters for the sexton of St. Luke's Church. The sink does not appear to be that old itself. The original kitchen was lost when the Grange was moved in 1888-1889. It probably was equipped with an incoming supply of water by about 1845, when the Ward family took possession of the Grange: New York City water was available in this area after 1842, the year the Croton Aqueduct was completed. However, one bill pertaining to the construction of the Grange in 1802-1804 notes payments for pipes. These probably drained water from the sink, as mentioned in Section B, "Basement Analysis, Original Cellar," but may have brought in water as well.

The two bathrooms in the basement are adjacent to one another. The one under the first-floor north hall apparently was put in when this floor was built in 1888-1889 (Ills. 72, 73). The other — under the northwest room — seems to have been added later. There also appears to have been a small bath in the very back of the first-floor north hall c. 1925 (Ills. 72, 73). This is no longer there. The appraisal made after the 1933 restoration lists only two bathrooms — presumably the one on the second floor and that in the basement. Thus, it seems that the first-floor bathroom was removed in 1933, and that the later basement bathroom was added after 1933.

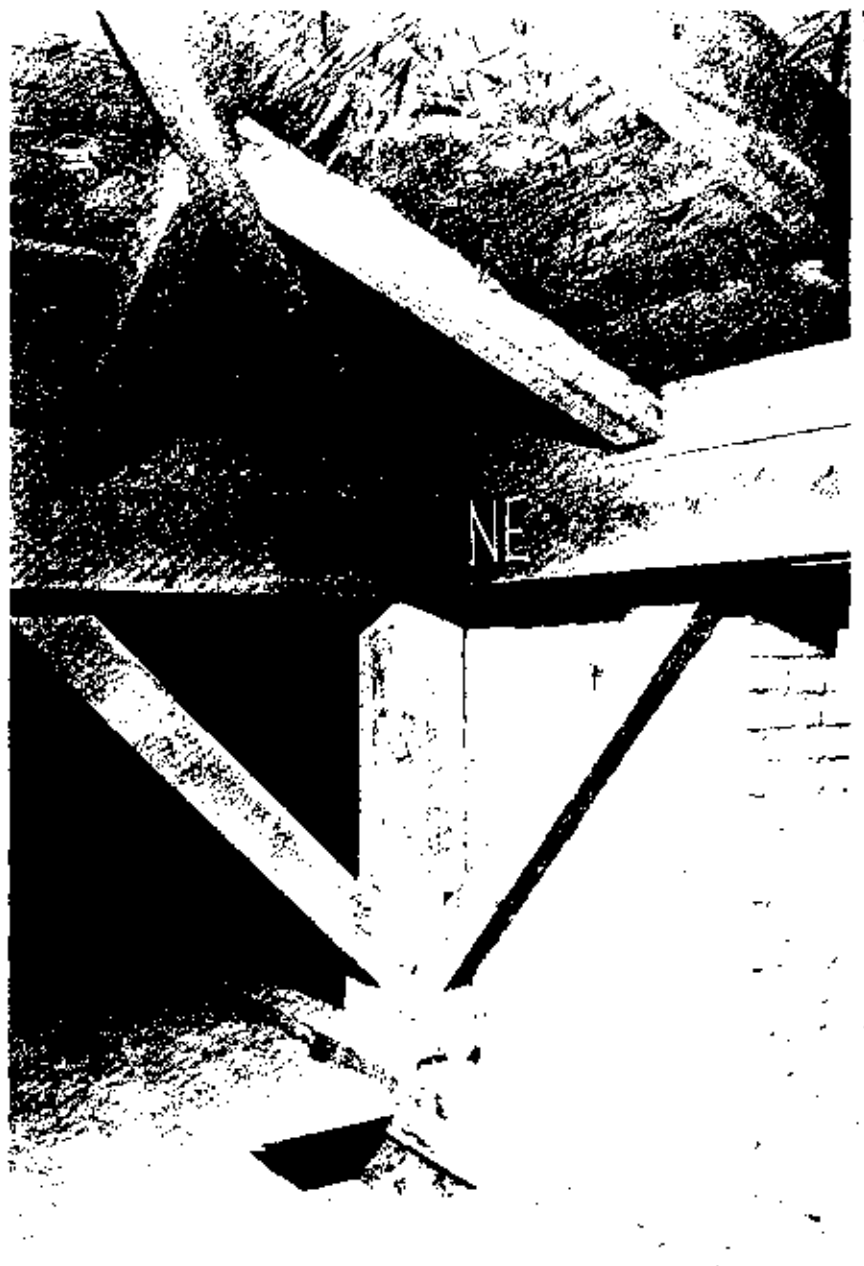

Illustration 104. The Grange: Attic, Roof and Floor Framing (1964).



Illustration 105. The Grange: Attic, Roof Framing (1964).



Illustration 106. The Grange: Framing Evidence of Settlement (1964).

The bathroom on the second floor was installed in the closet space that was created when the original north room here was subdivided between 1810 and 1820. The first toilet fixtures undoubtedly were installed by the Ward family: Illustration 35 — taken before 1876 — shows what appears to be a waste pipe descending from the vicinity of the present bathroom. It is likely that the Wards introduced the bathroom early in their occupancy, about mid-century. Most New York City houses of this size had interior bathrooms by this time, with city water having been available since 1842, and the wealthy Wards probably would have had all the creature comforts.

The Hamiltons, of course, would have had to rely on the "necessary house" mentioned in one of John McComb's bills. The location of this structure is not known, because it does not appear in Illustration 24, the 1819 plan of the Grange's outbuildings.

Electricity

The Grange presently has 150-ampere electrical service, with BX cable carrying most circuits. The present wall sconces (Ill. 84) were designed for the Grange as part of the 1933 restoration, when electricity was installed in the house.[3] The sconces were to be as much like the "fixtures" the Hamiltons would have known: candles and oil lamps. (See also Section A, "Interior Fixtures.") Prior to 1933, gas was used to illuminate the Grange, as indicated by the now-inactive gas pipes beneath some Grange floors. This utility must have been brought in by St. Luke's Church: it became available in the Grange neighborhood in the 1880's-1890's.

Security

The current fire- and intrusion-detection systems were installed during the winter of 1980-1981. The fire-alarm system includes one ionization-type detector in every basement room, and in every room on the first and second floors. The attic and subbasement each have a thermal-type detector. Alarms are telephoned by a dialer to a 24-hour monitoring service run by the Wells Fargo company. There is also an audible alarm signal.

The intrusion-detection system consists of magnetic contacts on all exterior doors and windows of the first floor and basement, and on all hall-to-room doors on the second floor. Two motion detectors further guard the basement -- the most likely point of entry.

* * *

Diagrams of the Grange's mechanical systems are included in architect Archibald Anstey's drawings from the 1933 restoration (Ill. 74); in Newton P. Bevin's 1964 Restoration Drawings (Appendix J); and in the Denver Service Center's 1978 "Restoration of Hamilton Grange, Phase I: As Constructed Drawings" (Appendix K). The locations of utilities in the street are recorded and on file in the New York City Department of Buildings.

NOTES

1. Memorandum from Barry Sulam, NPS Historical Architect, to Howard Glifort, NPS Project Supervisor, June 27, 1979. Copy in NAHPC files.
2. Superintendent of Manhattan Sites files, Federal Hall.
3. Minutes, meeting of the board of trustees of the American Scenic and Historic Preservation Society, January 29, 1944.

IV. FINISHES ANALYSIS

A. Exterior Finishes

Introduction

This material represents a summary of a more exhaustive paint study conducted 1977-1979, which was done to determine the Grange's original paint types and colors, and to find suitable restoration finishes. That study, entitled "A Finishes Study of the Exterior of Hamilton Grange National Memorial, New York, New York," was prepared in October 1979 by Carole L. Perrault, an architectural conservator with the North Atlantic Historic Preservation Center of the National Park Service (NAHPC).

Perrault's study incorporated documentary information compiled in 1977 by Anne D. Whidden, as part of her research for the architectural data section of the historic structure report for the Grange. This historical research indicated that the exterior of the Grange was to be painted originally. There are two references dating to the period of construction that mention house paints. The first is located in the Alexander Hamilton papers; it is a bill of June 28, 1802, for \$118.00 for house paints (see Mongin, p. 37, and Appendix A). The second is a letter from Philip Schuyler to Elizabeth Hamilton, mentioning the loss of paint and oil destined for the new house (Appendix B). Neither reference indicates the specific materials involved.

Whidden also took a number of paint samples from the exterior surfaces of the Grange. However, she believed that the building had been stripped of its early finishes. This was based largely upon an April 22, 1933, letter from the secretary of the American Scenic and Historic Preservation Society to Alexander Hamilton, a descendent of the Grange's original owner. This letter read:

Mr. Anstey would appreciate a decision as to the method of removing old paint from the front of the Grange. Paint remover is expensive. A torch would be quicker and cheaper, but the risk of fire in inexperienced hands is, of course, to be considered.

This information was found by Whidden in Mongin's card file, under the category "1933," at Federal Hall National Memorial in New York City.

Following the termination of Whidden's appointment with the National Park Service, Carole Perrault was assigned to complete the paint study, in conjunction with the Phase I stabilization project. Perrault found that while portions of the siding had been stripped, other areas had not. During her quest for paint samples, the area above the west piazza's roof was entered, and its wealth of information about the alteration of the porch roofs discovered (see Ill. 78). The flushboard siding in this area still featured its early color, and traces of a red roof paint were found. The latter indicated that the original porch roofs were of red-painted metal.

It was decided to restore the porch roofs and all exterior finishes to Hamilton's time, so the collection and analysis of paint samples continued throughout the stabilization work of 1978-1979. The results of the paint study, and the ensuing recommendations, were made available to Denver Service Center Exhibit Specialist

Howard Glifort in August 1979. Over the next two months, the exterior of the Grange received a paint treatment based upon the findings and recommendations of the study.

Methodology

Approximately 115 samples, removed from the exterior of Hamilton Grange National Memorial between August 1977 and August 1979, provided the basis for this study. The samples were removed by various individuals involved with this project: Anne D. Whidden, Sharon K. Ofenstein, E. Blaine Cliver, Frank G. Matero, and Carole L. Perrault. The laboratory methodology for the processing and analysis of the paint samples was that employed by the North Atlantic Historic Preservation Center. The research data and paint samples are stored at the NAHPC, available for reference.

Numerous samples were extracted from the exterior of the Grange, for the purpose of relatively dating architectural elements based upon a comparative study of the specimens' chromochronologies. This dating aspect of the finishes analysis is not discussed at any length in this summary. Only the data related to the identification and analysis of the original finishes is included. The research data is summarized below, by architectural element.

Siding

Thirty-nine paint samples removed from the siding were analyzed to determine the c.-1803 finish. Prior to the opening of the west piazza's ceiling, it was difficult to determine the earliest color of the siding from the areas of siding then accessible, because of the extensive deterioration of the paint layers closest to the substrate. The deteriorated samples made it particularly difficult to distinguish one layer from another, and primer coats from finish coats.

Two samples were viewed as having the most complete history: sample P364, removed from the east piazza at the molding joint for the later ceiling; and sample P383, taken from the west piazza's north engaged column, where it abuts the flushboard siding. As representative samples, they indicated that the siding's earliest finishes were light colors. These gave way to deeper colors, which in turn were followed by whites; the latter were used for a good portion of the Grange's later existence. The last painting -- done in 1967 by the National Park Service -- painted the house a yellow ochre, purportedly based upon research. At that time, project architect Newton Bevin wrote to NPS historical architect Henry Judd that a bit of "the original or an early color -- a raffia" had been found on the edge of one of the leaded sidelights of the tripartite window. (A copy of this letter is in File #6 of the Superintendent of Manhattan Sites' files at Federal Hall.) Perhaps Bevin had discovered some of the later mustard-yellow color found in substantial amounts in the samples removed subsequently by the NAHPC staff: the earlier yellow ochre layers are generally deteriorated (appearing white), making them difficult to discern, even under a microscope. Because of this, the most prominent early layer on these samples appears to be the mustard-yellow.

After the west piazza's ceiling boards were removed, and the original elements above the later ceiling were discovered, a more definitive analysis could be conducted. Illustration 78 shows these elements. Sample P363 (Ill. 107) was taken from Area #1 -- a portion of original flushboard siding, with its paint still in relatively good condition. This sample exhibited approximately four layers of paint: white, yellow ochre, white, and pinkish buff (discolored). Relating this sample to sample P349 (Ill. 108) -- removed from the sheathing above the original roof line on the west piazza -- a comparison of the thickness between a primer and finish coat was possible. Sample P349 featured only one thin layer of paint (coated with dirt), which was obviously a primer. The primer was tested chemically to be white lead pigment in an oil vehicle, presumably linseed oil.

A cursory review of the samples removed from the inside of the piazza roof suggested that the earliest layers appeared to feature only white paint, but further analysis indicated evidence of a yellow ochre pigment in two layers (the second and fourth). Evidence of this pigment, in addition to the yellow color of those layers, could not be disregarded. Selected paint samples were placed under near ultraviolet light for approximately 150 hours. The bleaching effect of the near ultraviolet light made the distinction more pronounced between the white layers and those that appeared to contain yellow ochre.

It is perplexing that a large number of the samples removed from the exposed siding exhibited the mustard-yellow layer closest to the substrate. These samples do not seem to feature the residue of paint removal. At the same time, the researcher can not discount the fact that the original flushboards -- protected over the years by the lowered piazza roof -- consistently exhibit the layers of white and yellow ochre closest to the substrate. This anomaly is left unsolved, and the conclusions for the study rely upon the samples from original boards located at the piazza ceiling height. Polarized light microscopy is a technique that may be employed to more clearly identify the existence of the yellow ochre pigment in the paint of deteriorated samples.

Sample P363 was used for purposes of color matching. It was removed from the west elevation's flushboard siding, from the area inside the west piazza roof, above the later ceiling. This sample exhibited four layers; the second up from the substrate was matched. It was recommended that all siding be painted this color.

COLOR NOMENCLATURE:	yellow buff
MUNSELL NOTATION:	between 10YR 8/4 and 10YR 8/6 (closer to 10YR 8/4)
PAINT TYPE:	Benjamin Moore Moor-O-Matic II color GB-4
TRICHROMATIC COEFFICIENT FOR BENJAMIN MOORE GB-4:	
	x = .375
	y = .376
	Y = 62.44

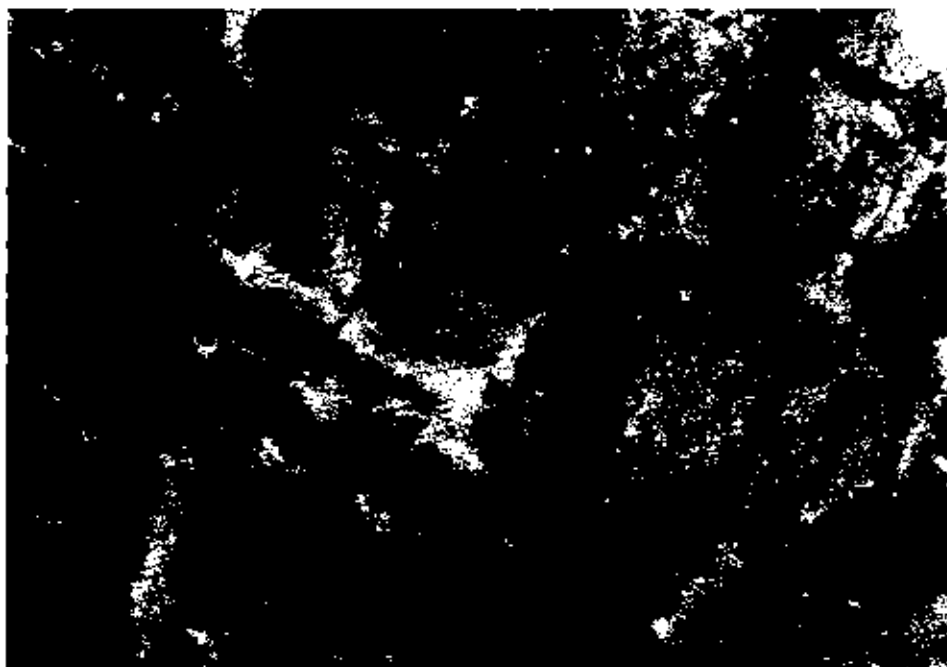

Illustration 107. The Grange: Exterior Paint Sample,
Original Siding Paint (1978).



Illustration 108. The Grange: Exterior Paint Sample,
Original Primer for Siding Paint
(1978).

Trim

The areas referred to as trim include the entablature, columns, cornerboards, windows (frames and sash), shutters, railings, and doors. Research into the finishes for these elements indicated that they were white when the siding was yellow ochre. A discussion of individual architectural elements follows. The color-matching data is included at the end of this discussion.

Entablature. The cornice is integral to the built-in gutter system on the main roof of the Grange, and it has been identified as being original to the house. Seven samples were extracted from the protected surfaces of the original cornice/frieze of the west elevation, including sample P026 (fl. 109). All of the samples removed from these surfaces appear to contain a rather complete paint history for the feature, in varying degrees of deterioration.

The layers closest to the substrate form a distinct stratigraphy, unlike those specimens removed from the siding. Sample P027 was used for color-matching purposes. This sample was extracted from the west piazza roof, from a triglyph of the entablature. It features approximately 30 paint layers. The first finish paint layer was white, as was the earliest layer on every other sample taken from the entablature.

In some of the chromochronologies for these samples, a yellow substance is seen. This yellow substance may be an extremely thin primer layer, having a high concentration of oil, which has penetrated the wood.

A chromochronology pattern began to develop for trim elements that made the identification of the original fabric possible merely by viewing the stratigraphies of their samples. The presence of numerous layers, with the first layers generally being white, followed by a series of colors and then whites again, indicated that the specimen contained a complete paint history for the cornice.

Testing for lead with sodium sulfide was not useful in the identification of specific layers, because the chemical reacted positively with all of the early layers, turning them black instantaneously. Other chemical tests were equally unhelpful.

Columns. The samples were extracted from the engaged columns, which were hypothesized to be original. The samples were taken from the face of the columns, rather than adjacent to the siding. On the siding are ghost marks indicating that the engaged columns had been positioned differently at several times throughout the history of the house. An area directly behind the column remained unfinished, corroborating the fact of the engaged columns' originality. Sample P366, from the base molding of the west elevation's southern engaged column, offers the most complete history; it features white adjacent to its substrate. This sample was used for color-matching purposes.

Windows. Of the 20 samples removed from the windows (frames and sash), the specimens that were removed from hypothesized original fabric contain white as the first finish layer. The most representative samples are as follows: sample P035, west elevation, second floor, casing of south center window; sample P036, west elevation, second floor, sash of south center window; sample P399, south elevation, first floor,

west window surround; and sample P402, east elevation, first floor, center window surround, south side above earlier shutter hardware. Each of these samples is composed of approximately 20 layers. The white found at the bottom was used for color matching; it is similar to that found on other trim.

Shutters. Fourteen samples were extracted from exterior shutters. These samples were useful in dating the shutters relatively, in collaboration with the data uncovered in the fabric research. Sample P368, from a solid-panel shutter stored in the cellar, was employed for color matching, because it appeared to have the complete chronology intact. The shutter samples had generally fewer layers than those found on other trim elements. However, the paint layers indicate that the solid-panel shutters, at least, are original to the Grange: they include the earliest white trim color, as well as the slightly later rose-brown color found on the siding.

Railings. In 1977-1978, the west piazza railing section just north of the portico appeared to be the earliest railing, based upon its profile and the fact that its balusters were mortised into the rail. Sample P353 reflects the paint history for this element.

There is evidence of attempted paint removal on the majority of the samples taken from the railings. Sample P353, however, represents a distinctly clear stratigraphy. The finish layer adjacent to the substrate featured white paint.

Doors. Two samples removed from the west elevation's front door did not provide any clue as to its first paint treatment. (Only a few layers of paint were found.) Further research is required, but for the interim, exterior doors should be painted white, like the trim.

COLOR MATCHING FOR TRIM ELEMENTS

COLOR NOMENCLATURE:	white
MUNSELL NOTATION:	5Y 9/1
PAINT TYPE:	Benjamin Moore Moor-O-Matic II color OW-69
TRICHROMATIC COEFFICIENT FOR BENJAMIN MOORE OW-69:	
	x = .326
	y = .335
	Y = 80.69

Porch Floors

Visual analysis suggested that a large number of the decking boards were replaced over the years. The boards adjacent to the west piazza's northwest engaged column were thought to be early, because of their wear and random sizes. Paint samples removed from these boards indicated that they were early: numerous layers



Illustration 109. The Grange: Exterior Paint Sample,
Original Cornice Paint (1978).

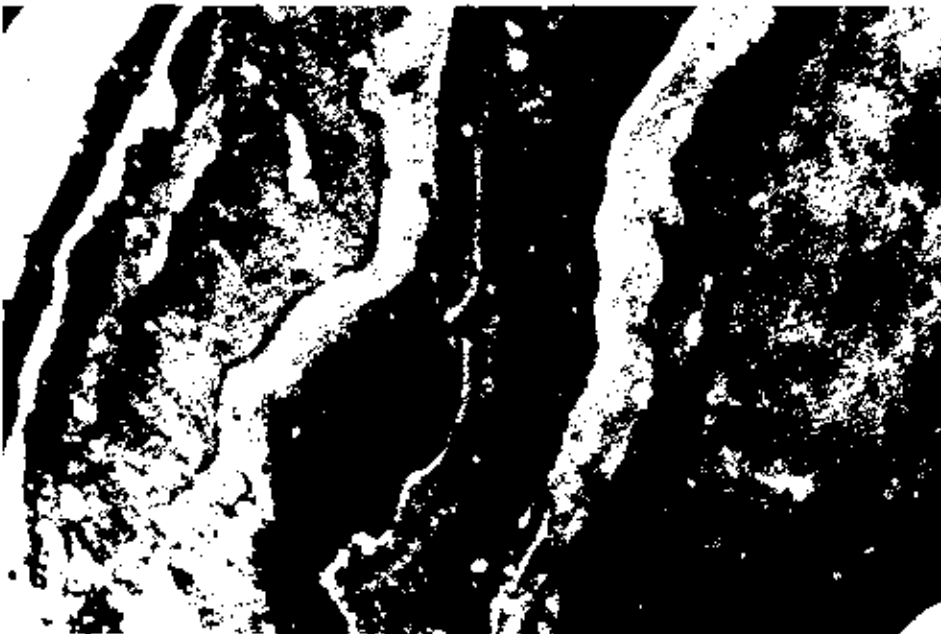

Illustration 110. The Grange: Exterior Paint Sample,
Early Piazza Floor Paint (1978).

of paint were found in the samples' stratigraphies. (Approximately 26 layers of paint were identified on sample 377 (Il. 110), from the west piazza's north corner floorboard.) The earliest layer of paint on the floorboards was a gray-green. This was chosen as the layer for color-matching purposes, using sample P377.

COLOR NOMENCLATURE: gray-green

MUNSELL NOTATION: closer to 10Y 5/2 (sample specimen a bit lighter in shade)

PAINT TYPE: Benjamin Moore Moor-O-Matic II color GN-68

TRICHROMATIC COEFFICIENT FOR BENJAMIN MOORE GN-68:

x = .311
y = .344
Y = 23.08

Porch Roofs

Opening up the area between the later piazza ceiling and the roof of the west elevation, evidence of red paint was found where the original roof of the piazza apparently abutted the wall (Il. 78, Arrow 7). Four samples of this paint were extracted. Only one layer of paint was found on the samples. The samples did not react completely to sodium sulfide, but there was a slight reaction. This reaction may be attributed more to the presence of white lead pigment in the exterior siding finish — which was splattered on the red paint — than to the composition of the roof paint. Sample P335 (Il. 111), from inside the west piazza roof at the junction of the original roof with the wall, was used for color matching.

COLOR NOMENCLATURE: red

MUNSELL NOTATION: 10R 3/6

PAINT TYPE: Calbar National Tinnors Paint, Tin-o-lin (light red: iron oxide paint ground and mixed in linseed oil)

TRICHROMATIC COEFFICIENTS FOR CALBAR PAINT LIGHT RED:

x = .384
y = .372
Y = 9.01

Chimneys

The two false chimneys were studied as part of the exterior finishes study. Under the metal cladding material is evidence of an earlier treatment. This consists of horizontal, painted, tongue-and-groove boards covering the chimneys. Their paint sequences featured several layers: red, white, rose brown, green, and some yellow ochre splattered on the surface (Ill. 112). This indicates that the tongue-and-groove boarding was original to the construction of the house: the third layer, a rose brown, relates to the second finish coat found on other stratigraphies from 1803 fabric. The white layer did not appear consistently throughout the stratigraphy. This fact may indicate the presence of penciling to simulate brickwork — a possibility that needs to be investigated further. Sample P365 was used for color matching.

COLOR NOMENCLATURE:	red
MUNSELL NOTATION:	7.5R 3/6
PAINT TYPE:	to be matched to existing brick chimneys

The restoration of the chimneys was not undertaken as part of the Phase I work; therefore, the finish recommendations were not executed.

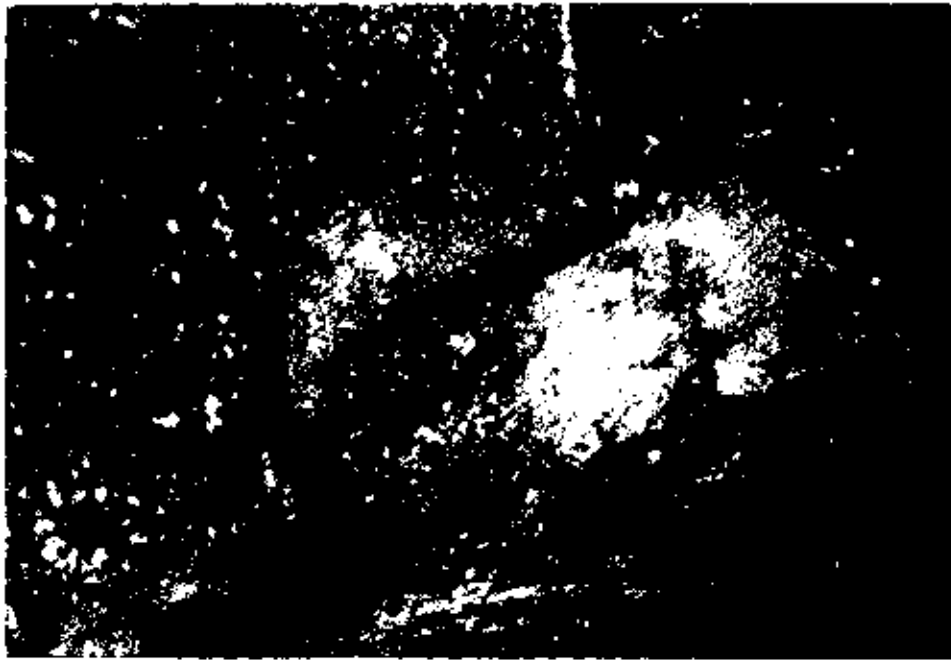

Illustration 111. The Grange: Exterior Paint Sample,
Original Piazza Roof Paint (1978).

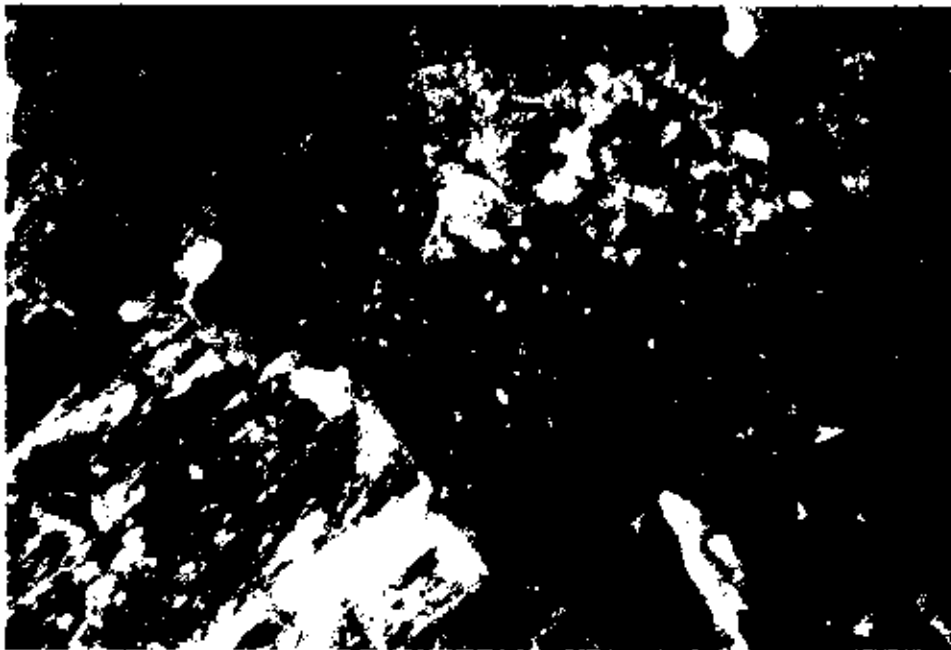

Illustration 112. The Grange: Exterior Paint Sample,
Original False-Chimney Paint (1978).

B. Interior Finishes

Introduction

Approximately 300 samples were taken from the interior of the Grange, over a period of time extending from 1977 to 1981. They were collected, processed, and analyzed according to the methodology used by the North Atlantic Historic Preservation Center. The samples, their analysis sheets, and other data are stored at the Preservation Center for ready reference.

General Patterns

During the analysis, the samples first were reviewed, to see if any general patterns emerged that would aid in the interpretation of individual samples. The wall samples thought to retain all of their paints contain about 20 layers, excluding varnish layers. The trim samples contain about 30. All follow the same general pattern seen in the exterior paint samples: early, light colors, covered by darker colors, followed in turn by a return to lighter colors. This sequence can be seen in such samples as P419 (wall); P259 (below-window panel); and P093 (casing).

Other samples from similar areas do not exhibit such extensive sequence. Most of these have only about 10 layers. This situation can be seen in such samples as P060 (wall); P154 (below-window panel); and P305 (casing). Obviously, a number of layers have been removed from interior Grange surfaces.

Another phenomenon that cropped up during the analysis process, was the resistance to sodium sulfide of many layers that probably contain white lead. The cursory application of this chemical to the samples produced the characteristic black color in a certain number of layers. However, it did not elicit this reaction from other layers that presumably did contain white lead, such as the earliest woodwork paints. The bottommost layer here was dissolved in the solvent dimethylformamide, and the sodium sulfide then applied. This did produce the characteristic white-lead reaction. The conclusion is that some of the Grange's white-lead paints contained enough oil to coat the white-lead particles and protect them from cursory applications of sodium sulfide.

This situation chiefly affects the chromo-chronology charts prepared from the analysis sheets and included here. The layers that reacted readily to sodium sulfide are circled, and they have been used to help correlate the sequences. However, because of the oil-coating effect, it is likely that a number of uncircled layers also contain white lead. This is especially true of the trim paints, but much less so of the wall paints, which seem to have been mostly water-soluble carbonates.

Walls

Data. The virtual absence of early paints in most samples from first-floor plaster wall surfaces can be best explained by assuming two things: the early use of water-soluble paints, followed by the extensive use of wallpaper. As was customary with calcimine painting, the early layers probably would have been washed off before repainting and wallpapering. The wallpaper itself would have taken the place of many later, oil-base paints. And paint applied atop the wallpapers would have been removed when they were taken down.

This hypothesis is substantiated by the evidence. The two samples that retain their early layers — P419 and P422 (Ill. 113) — reveal them to be carbonates. Appendix A indicates that wallpaper was used in the octagon rooms before and after 1886. That same source, and old photographs, prove that paper was used on the first floor after 1889. Paper also was used on the second floor: Sample P259, a panel in the northwest room, contains mechanical wood-pulp fibers. These are characteristic of wallpaper made after 1860 or so; the fibers' position within the chromochronology suggests that they are post-1900 in date.

That the earliest carbonates survived anywhere on the first floor, seems to stem from the apparently "second-class" treatment accorded the two apses. Judging by the number, color, and composition of the layers in the samples from these areas, the apses' calcimined walls were not washed down before repainting. And later, when most of the rooms around them were being wallpapered, the apses were painted with oil-base colors. These oil paints covered and protected the carbonate paints from later decorating efforts, which did see wallpaper hung in the apses.

Conclusions. The earliest finish found on nearly all of the wall-surface samples is an oily-looking layer that has soaked into the plaster, forming an ivory-colored "zone." This can be seen in such samples as P146, P120-123, P419, and P422. This could have been a decorative or protective finish on the plaster, but there is no dirt layer above it. The layer is most likely a varnish size, to seal the plaster for painting.

Samples P423 (Ill. 114) has the earliest paint found on any wall. It is a white carbonate, probably calcimine. Other water-soluble layers may have been applied and washed off before this one was applied. However, this sample must predate 1810-1820, because of its source: it came from underneath a partition installed during that period. It is therefore likely — without other evidence — that any earlier layers would have been similar to the one indicated by sample P423.

This information suggests that the original, historic wall treatment would have been the smooth, white plaster surfaces mentioned by John McComb, Jr., in his proposal of 1801 (Mongin, p. 28). There would have been little point in painting white plaster with white calcimine. The calcimine — and the varnish size — would have been introduced somewhat later, to freshen the plaster walls after they became dirty. Based on previous research in other buildings, this was certainly a common practice during this period.

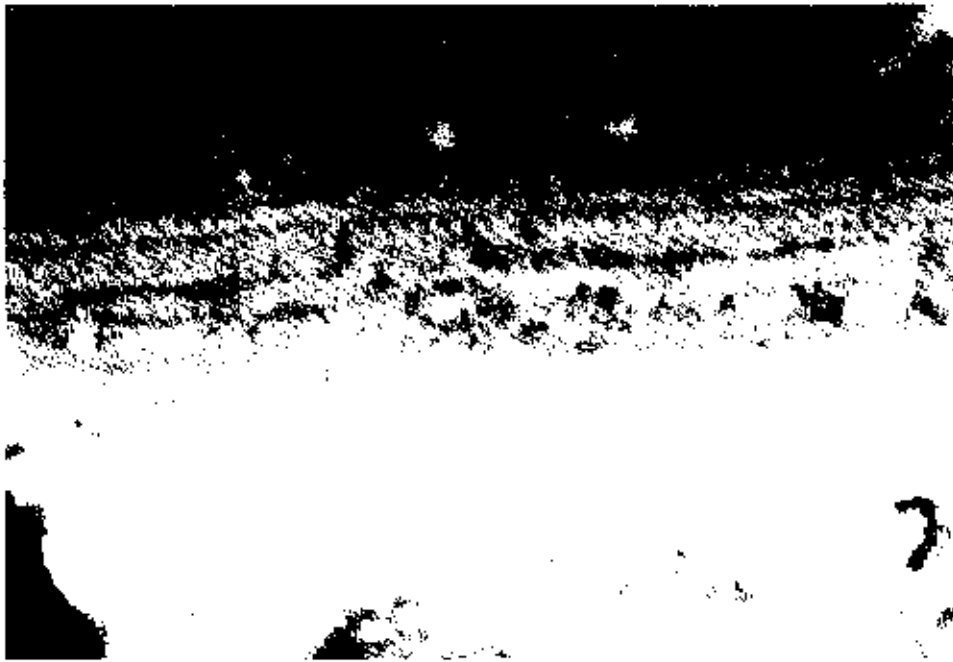

Illustration 113. The Grange: Interior Paint Sample,
North-Apse Wall (1981).



Illustration 114. The Grange: Interior Paint Sample,
Wall Under 1810-1820 Partition
(1981).

Interior Finishes: First-Floor Walls

Entry Hall	Stair Hall	South Apse	SE Study	West Octa.	East Octa.	NW Room	North Hall	North Apse	NE Room
								ivory	
								white	
		line						ivory line	
		white						white	
		olive varnish						ivory	
		greenish white	ivory					white	
		varnishy dark green	dark green					ivory	
		line			varnish			varnish line	
		steel	gray		yellow			white	
								varnish	
								white	
		white						white	
		light green	olive					olive	
		cream							
		white						rose	
		blue							
varnish cream	varnish white	varnish white	mint green	varnish cream			varnish white		varnish ivory
cream	cream	cream	light green	pink cream	ivory	dark ivory	white	white	
			varnish		varnish				
			cream		cream	white	dark cream		dark cream
yellow	yellow cream	yellow cream	light green	pink cream	cream	cream	cream	dark cream	cream
varnish cream	varnish cream	line white	varnish y.cream	varnish cream	varnish cream	ivory cream	varnish white	dirt white	varnish y.cream
blue	blue	blue	ivory	y.cream	cream	y.cream	beige	cream	cream
				varnish	varnish		line	dirt	
white	white		white	white	white	white	white		white
blue	blue		mint	mint	mint	cream	yellow	yellow	cream

1835?

1840's-1888?

'89?

'90?

'95/96?

'07?

Interior Finishes: Second-Floor Walls

SW Room	Front Hall	SE Room	W Ctr. Room	E Ctr. Room	Ctr. Hall	North Hall	Bath Room	NW Room	NE Room
white									
white									
white			ivory						
white			white			white			
white			white			ivory			
ivory			varnish						
white		ivory	white			cream			white
varnish		varnish	varnish			ivory			ivory
dark ivory		cream	white			cream			white
varnish	varnish	varnish	varnish	varnish	varnish		varnish		varnish
ivory	cream	white	white	ivory	ivory	ivory	white	white	ivory
varnish		varnish	varnish	varnish	varnish			varnish	varnish
white		white	cream	white	white	cream		ivory	ivory
ivory		white							
			varnish	varnish	varnish	varnish	varnish	varnish	varnish
	yellow cream	white	white	cream	ivory	white			white
d.cream		white	white	cream	d.cream	white	cream	cream	cream
	dirt	varnish	varnish			varnish		varnish	varnish
cream		white	cream	cream	cream	d.cream	yellow	cream	cream
cream	white	cream	ivory	cream	white	p.cream	d.white		cream
varnish		varnish	varnish	varnish	dirt			dirt	dirt
ivory		ivory					ivory	white	white
white	cream	ivory	cream	cream	d.white	d.cream	white	cream	white
varnish					dirt		dirt		dirt
white	white	white	white	white					
mint	blue	mint	mint	mint	blue	blue	camel	turg.	turg.

'89

'09

'14

'33

'50

'70

The progression of layers found on walls after 1810-1820 has been established on the basis of the number of layers present, their relationship to other elements such as moldings, and general stylistic knowledge. The early carbonate whites were followed in most instances by wallpaper. It is possible that only the most important rooms were papered at first, with other areas continuing to be painted with carbonates. Eventually most areas except the apses were papered, however, based upon the fact that all of the early carbonates are missing on most walls.

The apses apparently escaped this treatment. However, their colorful wall paints (see Illustration 113) end abruptly at a distinct varnish layer. This varnish layer is what most of the incomplete first-floor samples have as their first layer. Nearly all first-floor samples follow the same general sequence thereafter: two series of pastel paints containing white lead, and two series of pastel paints without white lead.

The fact that these layers rest upon the plaster walls means that the early wallpapers must have been removed prior to the layers' application, probably just before the varnish layer was laid down. There is no clear idea of when this took place. The redecoration of 1889 seems the most likely time. This is based upon the fact that such a move undoubtedly would have damaged interior plaster surfaces. There are also about eight layers of paint now upon the first-floor walls, even though it is known that wallpaper was used here, too. Finally, Illustrations 56 and 60 -- purportedly from 1889-1892 and 1892-1909, respectively -- show painted walls in the octagon rooms.

After the removal of the early wallpapers, paint and paper both were used. The documentary records (Appendix A) indicate that major decorating campaigns took place in 1889, 1892, 1909, 1912-1914, 1933, 1939, and 1970. (Work also might have been done in 1924, when the American Scenic and Historic Preservation Society acquired the Grange. Still more, second-floor painting was done by the Park Service c. 1975). These records, and the old photographs, indicate that wallpaper was the primary addition to the first floor in 1892 and 1912-1914. This leaves four or five campaigns when paint was the primary decorating tool -- which corresponds to the number of paint series seen in the samples.

The treatment of the second floor apparently was somewhat different. The samples from the walls here do not have as many layers as do those from the apses' walls. However, most of them have at least some early layers, and they do not begin abruptly at any one specific point.

The existence of the early layers seems attributable to the large number of varnish layers interspersed within the sequences. These would have consolidated the water-soluble paints and made their removal unnecessary. It also seems reasonable that wallpaper would have been used more sporadically here than on the first floor. The samples suggest seven series of paintings, including the work done c. 1975.

Woodwork

Data. The wooden trim samples are more difficult to interpret. A number of them appear to retain the complete historic sequence, based upon the number and

nature of their layers. This sequence consists of about 30 layers, as mentioned, in the following order:

- 7-10 early whites
- 9-13 intermediate layers, mostly colorful earth tones ranging from persimmon to olive to steel gray
- a distinct varnish layer
- 2-3 series of whites and creams containing white lead
- 2 series of creams and pastels without white lead

These layers are seen in such baseboard samples as P062, P237, and P413, and casing sample P093 (Ill. 115).

A large number of trim samples lack this complete sequence. They tend to go back only to the varnish layer. Other samples evince the limited sequence, plus jumbled scraps of the earlier, intermediate colors. This information — and the fact that relatively permanent oil-base paints generally were used on trim elements — suggests that most of the Grange's interior woodwork was stripped of its early paints. In 1981, NPS employees found scrape marks on some woodwork elements, but not burn marks. This points to the use of chemical paint removers such as caustic alkalis, which were available before 1893.

This stripping could have been done at any of several times. The remodeling of 1889 is a remote possibility. Samples from elements introduced at that time have the same layers as do original, stripped elements. However, the four or five series of paint layers applied after the stripping would seem inadequate for the seven to nine Grange decorating campaigns.

The redecorating work of 1912-1914 is a better possibility. A newspaper article of March 1913 (see Appendix A) says that "Recently these rooms [those on the first floor] have been covered with the wall paper of their period and the wood work restored to the original Colonial white." This is a good indication that the first-floor woodwork was something other than white prior to 1912. It might have been a shade as similar to white as cream, but it also might have been the last of the colorful layers. Additionally, it is possible that the author's citing of "original Colonial white" was based upon his actual observation of the early layers during stripping.

The date when the second-floor woodwork was stripped may be different from that pertaining to the first floor. The 1913 newspaper article makes it clear that the work accomplished was confined to the first floor — although it was planned to decorate the second-floor rooms "in their original color schemes," too. It is likely that nothing more was done until 1914, when both floors were renovated. Therefore, it would seem reasonable that the second-floor woodwork was stripped in 1914. However, the samples contain one layer too many for this theory to fit perfectly. Either the woodwork here was stripped earlier than that of the first floor; or the extra layer is actually part of one of the other series seen in the samples; or an unrecorded painting took place between 1912-1914 and 1975.

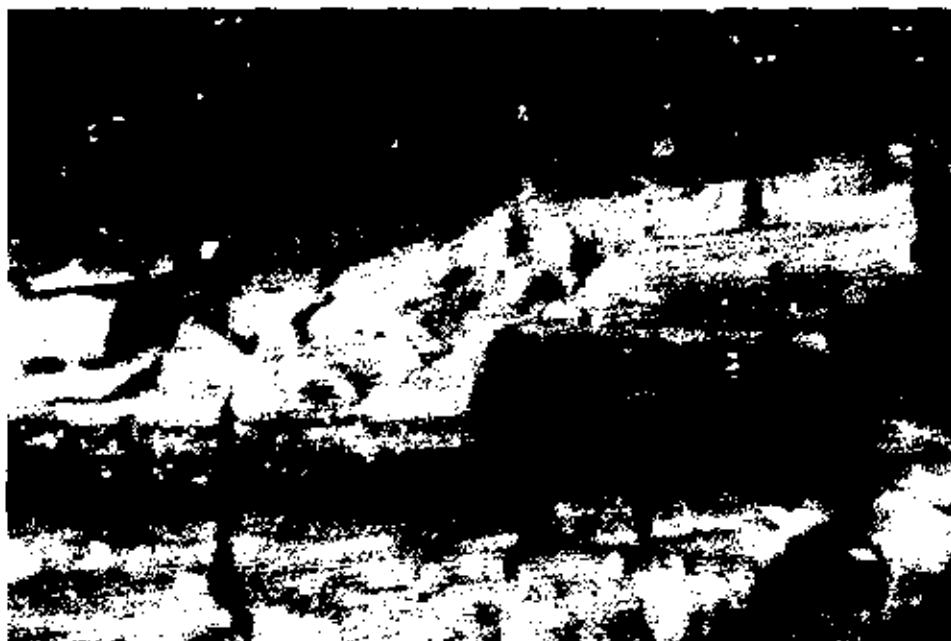

Illustration 115. The Grange: Interior Paint Sample,
First Floor Southeast Room, Casing of Hall Doorway
(1981).



Illustration 116. The Grange: Interior Paint Sample,
Second-Floor Southeast Room, South Window Frame
Below Sash Cord-Pulley Plate (1981).

Interior Finishes: First-Floor Woodwork

Entry Hall	Stair Hall	South Apse	SE Study	West Octa.	East Octa.	NW Room	North Hall	NE Room	North Apse
		white	white				white		
		white	white				white		
			(white)						
		white	white						
			(white)						
			(white)						
		white	white				white		
		white	white				white		
			varnish				varnish		
		white	(cream)				white		
	white	white	white	white			white		
			varnish				varnish		varnish
	olive	olive	d.olive						
	khaki		l.olive						
	persim.	persim.	persim.	persim.	persim.		persim.		
				olive	khaki		olive		
				steel	steel		steel		steel
				l.kh.			rose		
					camel		camel		camel
	(d.white)						d.white		(ivory)
	cream						varnish		varnish
	cream						white		ivory
	varnish					varnish	varnish	varnish	varnish
	ivory	white	l.aqua	white		white	d.white	white	
	(ivory)	(white)		(white)	(ivory)	(white)	(white)	(white)	(ivory)
	(cream)	(white)	(white)	(white)	(cream)	(white)	(cream)	(cream)	
								varnish	varnish
	(white)	(white)		(cream)	(ivory)	(white)	(white)	(cream)	(white)
			dirt	dirt		varnish			
					(white)	(cream)	cream	cream	ivory
						varnish	varnish	varnish	
	(beige)	(cream)	(white)	(white)	(beige)	(ivory)	(d.white)	(white)	(white)
		dirt				varnish	dirt		(cream)
	white	cream					white	ivory	
	blue	blue	blue	cream		cream	cream	cream	cream
					dirt	dirt	dirt		dirt
	white		white	white	white				
	cream	cream	cream	yellow	mint	mint	cream	cream	cream
								cream	ivory

1843-1912?

'12

'14

'22

'25

'27

Interior Finishes: Second-Floor Woodwork

SW Room	SE Room	Front Hall	W Ctr. Room	E Ctr. Room	Center Hall	North Hall	Bath Room	NW Room	NE Room
		varnish	varnish	varnish	varnish				
(ivory)		white	(white)	(ivory)	(white)				
			varnish	varnish	varnish				
		cream	cream						
(white)			(white)	(cream)	(ivory)				
		ivory		ivory	white		ivory		
	varnish	varnish		varnish	varnish				
	white	white		white	white	white	white		
(white)	(rose)	pink	(d.white)	(ivory)					(white)
	(camel)		(camel)						
	(olive)		(olive)						
	khaki	varnish		varnish		khaki	khaki		varnish
				mauve			rose	(rose)	(d.pink)
	persim.	persim.		persim.	persim.	persim.			persim.
			(khaki)	ol.kh.				khaki	(ol.kh.)
(ivory)			(pink)	(d.white)			(d.white)		
							(algae)	(algae)	
white		white		d.ivory					
		varnish		varnish	khaki	varnish	varnish		
camel	d.white	d.white		d.white	white	ivory	dirt		steel
		olive		varnish	varnish	varnish	olive		varnish
		cream	ivory	ivory					
(khaki)	(white)			(white)	(ivory)	(ivory)		(rose)	rose
							khaki	khaki	khaki
	varnish	varnish	varnish	varnish	varnish	varnish	varnish	varnish	varnish
(ivory)	(white)	cream	(ivory)	(white)	(ivory)	(ivory)	(ivory)	(ivory)	(cream)
varnish		varnish	varnish	varnish	varnish	varnish			
(ivory)	(white)	(white)	(cream)	(ivory)		(white)		(white)	(cream)
varnish		varnish							
white	(white)		(cream)	(ivory)	(ivory)	(white)	(ivory)	white	
varnish								varnish	
(ivory)	(ivory)	white	(cream)	(ivory)	(cream)	(white)	(cream)	(ivory)	(cream)
	varnish	varnish					varnish		
(white)	(white)	white	(cream)	(ivory)	(d.white)	(white)	(d.ivory)	(cream)	(cream)
	varnish	varnish	varnish		varnish	varnish			varnish
		cream	cream		white	cream			cream
(ivory)	(cream)		(white)	(white)	(white)	(white)		(d.white)	(white)
cream			ivory					white	
dirt	dirt		dirt	dirt	dirt	dirt	dirt	dirt	dirt
		white					white	white	turc.
white	blue	blue	p.cream	white	cream	cream	cream	d.cream	camel
yellow	yellow	cream	white	white				yellow	yellow

18405-1147

147

337

397

757 70

Finally, the stripping might have been done in 1933, when records indicate that the exterior paint of the Grange was stripped (see Section A, "Introduction"). This restoration was a painstaking effort, and it is plausible that interior paint removal would have been attempted. The five to six paint series on the stripped elements would seem a little excessive, however, for such a late date.

The photographic evidence indicates that 1912-1914 and 1933 are the more likely dates. The photographs from 1889-1909 (Ills. 52, 56, 60, and 61) show casings, door panels, and recessed areas of arch trim painted a darker color than the walls and remaining trim elements (door stiles and rails, baseboards, etc.). However, the paint samples from these areas do not show any dark colors in a position to correspond to the 1889-1909 time period. A blue does appear later, in a position to suggest a 1939 date. The removal of trim paint after 1909 would best explain this phenomenon.

The paint samples from the picture molding complicate matters. This molding encircles spaces created in 1889, so it must postdate the move. Most of the paint samples from the picture molding have only about five series of paints, like the stripped trim samples. This would indicate that the molding was put up at about the time the trim was stripped. However, a dark picture molding appears in Illustration 60, datable by its residential furnishings to 1892-1909. (It is also present in Illustration 56, which ostensibly precedes Illustration 60. However, this photograph appears to have had its furnishings drawn in, which makes the entire photograph suspect.)

In sum, the picture moldings now in the octagon rooms may either predate the picture moldings in the other rooms, or they may have replaced older ones when picture moldings were installed throughout the Grange. The former idea seems the most likely for the west octagon's picture molding: it does retain some of the earlier, darker colors (P114). The replacement idea seems most probable for the east octagon room's picture molding, which does not have any of the darker colors (P128).

Conclusions. The earliest trim paint is seen in the samples thought to have complete historic sequences, already mentioned, and in sample P195 (Ill. 116), which comes from below a sash cord pulley plate and has only the earliest layers. This paint seems to be an oil-base paint containing white lead, with calcium carbonate or a similar material added as an extender. This is based upon the layer's positive reaction to both sodium sulfide (after dissolution in dimethylformamide) and hydrochloric acid.

The use of such paint probably persisted throughout the Grange's early period. The rest of the early layers resemble the first in appearance and response to cursory chemical testing, and it seems reasonable to think that they are the same type of finish.

After the early whites came the intermediate earth colors, which seem to correspond roughly to the Victorian period. Judging by their relationship to the early whites, the colorful paints probably were introduced when the Ward family moved into the Grange, c. 1845.

Some of the colorful layers reacted readily to sodium sulfide, while others did not. Historical painting practices would indicate that all probably contain lead white, along with their various colorants. Therefore, it seems likely that the chemically resistant-coating phenomenon seen among the early white layers holds true here, too.

These colors end at a distinct varnish line, which is the first layer found on most of the incomplete samples. Thus, it seems that the old paint was removed, the wood varnished to seal it, and new paint applied.

The post-stripping paints, seen in all of the samples, consist of what looks like several series of leaded paints, followed by two series of paints without white lead. Those used last in the second-floor center rooms appear to be latex paints, based upon the rubbery appearance of the layers and their resistance to sodium hydroxide.

The samples from the original doors in storage (P424), taken from under the escutcheons, vary considerably. Some eight pieces comprise this sample. Six of these have a single white layer, followed by the colorful sequence and more whites. Two have only the first whites. Some of the escutcheons are original, based upon the early screws holding them to the doors. It is thus likely that the white is the earliest color, applied before the escutcheons were attached; and that some of the escutcheons either are not original, or were moved during later painting campaigns.

Window Panels

The plaster areas below the windows -- part of the trim treatment used in the Grange's moderately important rooms -- have sometimes been treated like wall surfaces and sometimes like trim elements. This is apparent in such samples as P131 (Ill. 117) and P208. The first four to eight layers are whites, which would have matched both wall and trim colors. The next group of layers are the colorful paints used on the wooden trim members around the panels. This has helped to correlate layers on the walls with those on the woodwork. Later, the panels seem to have been treated as wall surfaces: sample P259, which contains the wallpaper fibers, is from a panel in the second-floor northwest room. Recent painting campaigns have continued to treat the panels like walls, rather than trim elements.

Cornices

The plaster cornice samples (e.g., P118, P151, P420, and P412) show the same varnish size and early white carbonates seen in the samples from the plaster walls. These layers are followed by several of the less vivid of the earth colors used on wooden trim elements during the Grange's intermediate period. The sequences then exhibit the creams and whites of the Grange's later years, as well as the sienna color now found on several of the cornices. Interestingly, all of the layers -- including the earth tones -- are water soluble.

Because of the cornice samples' similarity to those from the walls, the cornices' historic finish was probably the same as that of the walls -- unpainted plaster, subsequently sized and freshened with white calcimine.

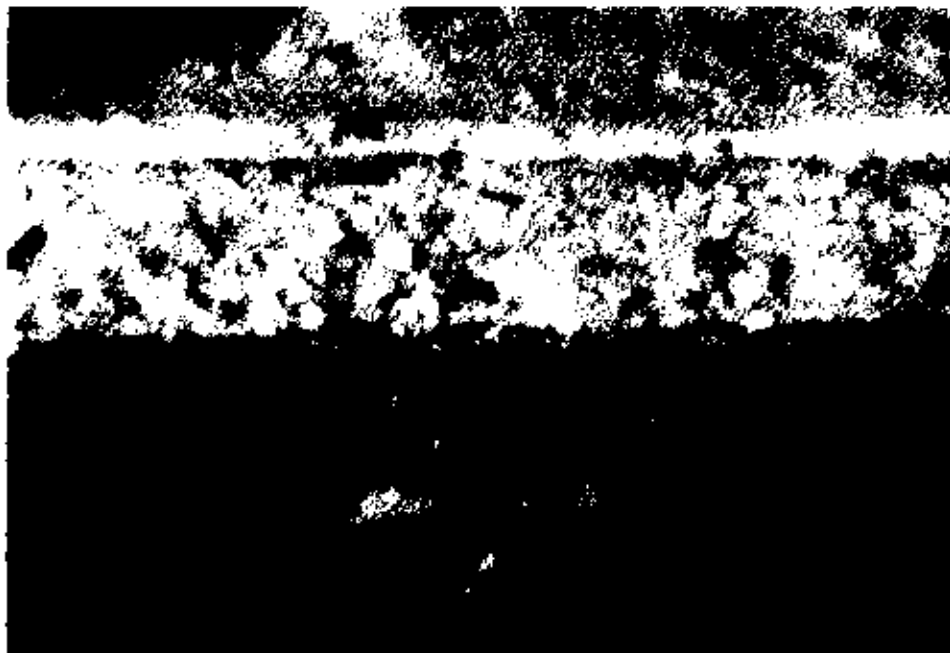

Illustration 117. The Grange: Interior Paint Sample,
First-Floor Northwest Room, North Wall, Panel
below West Window (1981).



Illustration 118. The Grange: Interior Paint Sample,
Second-Floor Southeast Room, Knothole in Floor
(1981).

Ceilings

All of the layers seen in samples from these surfaces are creams and whites without white lead. Sample P153, from the first-floor northwest room, has the most layers — about 13. This would seem to be too few for the ceiling of a room that has been used as hard as this one has. However, sample P220, from the second-floor west center room, has about a dozen whites and creams. It therefore seems likely that both samples are complete — especially if wallpaper was used upon the ceilings from time to time, as seen in Illustrations 52 and 61.

Based upon these samples, and their similarity to the samples from the walls and cornices, the historic ceiling treatment probably was the common one of white finish plaster. The carbonates would represent later efforts to brighten the surface.

Floors

Sample P181 (Ill. 118), from a knothole in the second-floor southeast room's floor, has a scrambled but intriguing chromochronology. It appears that blue-gray paint (Munsell no. 5B 5/4) was used at some early date, followed by white and camel paints, and then light and dark varnishes and shellac intermixed. This suggests that the floors of at least relatively unimportant rooms may have been painted during the early years, with shellac being used on floorboards not covered by carpeting during the Victorian period. However, all paint, and most old varnishes, have been removed from the surface of the floors (P180). Without additional information, the more normal floor treatment of no coated finish should be assumed.

Individual Rooms

These sections treat only the variations from the patterns just discussed.

Entry and Stair Halls. The front door here has several white-lead layers under its presumably original rim lock, but no vivid colors (P147). This differs from the sequence found on the original interior doors, but seems to be a product of the same process: only intermittent hardware removal during the various painting campaigns.

Apses. As mentioned previously, the apses' walls seem to have more layers than other walls because of their less-important status. The choice of colors used in these areas is interesting. Samples from the south apse's walls (e.g., P419) indicate that after an initial white layer, the early finishes of the walls here tended to be rather greenish. Normally, whites would be found in this position — just prior to the colorful sequence (see paint layer chart). During the intermediate, colorful period, this area was painted with fairly normal wall colors, such as pastel blues and greens. The walls of the north apse, however, were being covered with some of the same dark colors used on the woodwork at that time (P422).

First-Floor Southeast Room. The wall samples from this room have only about 12 layers. The earliest layer found on the samples (P086, 087, 089, and 091) — after the ivory sizing — is a glassy, forest-green layer (Munsell no. 10GY 3/6). A similar type of mint-green paint is found between the plaster and the forest-green coat in some places. It appears that the coating on the plaster was breached in these areas, and that the plaster, oil, and forest-green layer interacted to create the mint-green spots.

The forest-green finish may be a glaze: it is not water soluble, but it will dissolve in dilute hydrochloric acid. It does not react with sodium sulfide, and so probably does not contain lead. It may consist of an oil and a green pigment, possibly Scheele's green: the layer turns orange-brown when heated in hydrochloric acid.

It is unlikely that the forest-green layer was the historic finish. Firstly, its color is radically different from that of every other room in the Grange, as well as from generally accepted ideas of how a Federal house would have been decorated. It is, however, similar to a color used in the 1830's in the Ropes Mansion of Salem, Mass. Secondly, it is an oil-base paint, which does not seem to have been used on Grange walls until after the historic period. Finally, the green and its following layer, a dark gray, tend to correspond to the fourth and fifth colors found on the walls of the nearby south apse. (These walls have at least two early whites prior to their varnishy dark green.)

Taken together, the evidence suggests that the early white calcimines here were washed off before the dark green was applied in the 1830's — possibly by Isaac Pearson.

The paint samples from the cornice in this room (P099) suggest that it may not be original. While all of the other original Grange cornices retain a number of layers, this cornice has only the layers found upon its adjacent picture molding (P097, 098). It is possible that earlier, water-soluble layers were washed off the cornice when the woodwork was stripped. A check of the way in which the cornice is fastened to the wall would provide a clearer answer.

Octagon Rooms. The earliest color found on three out of four samples from the walls of the east octagon room (P120, 121, and 123) is a water-soluble yellow paint (Munsell no. 5Y 8/8), whose pigment can be bleached out by hydrochloric acid. The paint does show some indication of lead when tested chemically, but this could be attributable to the presence of a lead-compound drier in the varnish below it. This soluble layer apparently survived because it was followed by an oil-base cream containing white lead, also seen in the samples. It is possible that a similarly soluble green layer was used contemporaneously in the west octagon room: there are traces of a pale-green paint in sample P100. However, since no oil-base layer was applied over it, it apparently did not survive.

In any case, the limited number of layers in the samples — eight or nine in those from the east octagon room, and six or seven in those from the west octagon room — suggests that the yellow and green layers would not have been the historic ones.

Second-Floor Southeast Room. In 1977, when the majority of the samples for this paint study were taken, both sash of the east window were thought to date from about 1960, when new sash were installed to replace deteriorated original sash on the second-floor east elevation. Sample P200 -- from the lower of the two sash -- has only one layer of paint, which is consonant with this idea. However, sample P199 -- presumably from the upper sash -- has as many layers as the sample from the south window's original sash. (These layers are limited, reflecting the stripping campaign here.) Therefore, the upper sash in this room's east window was apparently an original piece retained and reused during the work of c. 1960. It was replaced along with the newer sash, unfortunately, in the work of 1978-1979.

Second-Floor North Rooms. This area originally was one large room, which was divided into four spaces between 1810 and 1820. The partitions put up during this work intersected original walls, covering over whatever finishes were upon the walls at that time. A sample taken from one such hidden area (P423) was examined. Including the plaster substrate, the finish sequence upon the 1802 south wall is as follows, beginning with the oldest layers:

- a brown coat of plaster
- a white coat of plaster
- one white carbonate paint
- a thin brown coat or a varnish layer
- a white coat of plaster
- a varnish size
- two carbonate creams
- a dusting of a water-soluble, caramel-colored substance

It thus appears that some type of plaster patching took place here before the 1810-1820 partitions were erected. The 1802 walls were probably treated in the usual manner originally -- unpainted plaster, followed by a size and a white carbonate, probably calcimine. For some reason, another white, skim coat was required shortly thereafter. This second white coat seems to have been put over either a varnish -- applied to consolidate the underlying calcimine -- or a thin brown coat. The new wall surface was then painted with the usual early white carbonates. A little later, the room was subdivided.

The 1810-1820 partitions covered over portions of original cornice as well as wall, and a sample was taken from one such place (P290). It shows the varnish size, followed by several whites and the caramel-colored "dusting" also seen in the hidden wall sample (P423). The chromochronology of the cornices after 1810-1820 can be largely seen in samples P276 and P311. The first sample -- from the northwest corner room -- is unusual, in that it does not have any of the vivid colors, even though samples from other elements in the same room do. From this evidence, one would assume that the cornice was painted to match the ceiling here during the colorful, intermediate period.

Related Information

Varnish Layers. The positions of these layers are where one would expect dirt layers -- i.e., between series of paint layers put on at different times. It thus appears that a layer of varnish was applied either over most of the finish coats -- as a decoration -- or before new paint layers were put down, to consolidate the preceding layers.

Some of the varnish layers also reacted positively to sodium sulfide, indicating the presence of lead. This is not unusual, since lead was frequently added to finishes as a drier. The compounds most likely responsible for the reaction would be red lead, litharge, or lead acetate. [1]

Documentation Problems. The photographic documentation of the Grange is marred by an apparent conflict between Illustrations 46 and 68. This question does not affect the study of the Grange's historic finishes, but its satisfactory resolution would enhance the reliability of the photographic record.

Briefly, Illustration 68 features:

- almost no furniture or carpeting
- a bust of Hamilton
- a credit line from the American Scenic and Historic Preservation Society
- a gasolier in the east octagon room
- a boldly figured but worn wallpaper and white woodwork

The first two elements suggest a memorial usage, rather than a residential one. This, and the Scenic Society credit line, would tend to date the photograph after 1924, when the society acquired the property. The gasolier would indicate a date prior to 1933, when the society electrified the Grange and introduced "period" lighting fixtures. The furnishings thus date the photograph 1924-1933. Taking into account the known decorating campaigns, it follows that the wallpaper is the semi-documentary paper hung in 1912, when the woodwork was painted white (Appendix A). However, Illustration 46 -- which appeared in a book in 1924 -- shows plain walls in the entry. Either this photograph predates the paperhanging of 1912, or else Illustration 68's wallpaper -- and Illustration 68 -- date from the renovations of 1933 or 1939. The former idea seems more likely. The photograph that is Illustration 46 is in the files of the Museum of the City of New York. It could have been taken well before 1924, filed away, and simply retrieved in 1924 for the book.

Suggested Retoration Finishes

Walls. The interior walls of the Grange -- including the below-window panels -- probably had only the smooth, white plaster as their finish during the historic period of 1802-1804. (A size and layer of white calcimine could have been applied toward

the end of the period.) If possible, modern white calcimine should be used as the restoration finish, to approximate the look of plaster. An alternative finish would be a flat latex paint applied with an airless spray, to achieve the smooth finish characteristic of plaster. Sample P101 was used for the purposes of color matching.

COLOR NOMENCLATURE: white
MUNSELL NOTATION: 5Y 9/1
PAINT TYPE: "Muralo Dutch Kalsomine" or
Benjamin Moore Moor-O-Matic I
color 14-14 (flat latex)

TRICHROMATIC COEFFICIENT FOR BENJAMIN MOORE 14-14:

x = .315
y = .323
Y = 87.26

Woodwork. These trim elements originally were painted with a white oil-base paint containing white lead and a carbonate extender. Sample P093 was used for color matching.

COLOR NOMENCLATURE: off-white
MUNSELL NOTATION: 5Y 9/1
PAINT TYPE: Benjamin Moore Moor-O-Matic II
color OW-69 (eggshell alkyd enamel)

TRICHROMATIC COEFFICIENT FOR BENJAMIN MOORE OW-69:

x = .326
y = .335
Y = 80.69

Cornices and Ceilings. These elements should be treated identically to the walls, with white calcimine or flat white latex paint.

Floors. Although sample P181 contains traces of floor paints, the evidence is too sketchy to support any finish treatment. All floors should be chemically stripped of their present layers, and left unfinished, until a new furnishings plan is prepared. (A more complete floor-paint study should be included in such a plan.) Some type of penetrating wax dressing, such as Hydrozo, might be applied to the floorboards to protect them.

NOTES

1. Richard M. Candee, Materials Toward a History of Housepaints, pp. 26, 35, and 155; John G. McIntosh, The Manufacture of Varnishes, pp. 260, 264-265; and Theodore Z. Penn, Decorative and Protective Finishes, 1750-1850, p. 64.

V. RECOMMENDATIONS

A. Definition of Historical Period

It would seem that the period to which the Grange should be restored is 1802-1804 — the years of Hamilton's occupancy. Congress authorized the Secretary of the Interior to accept the donation of the Grange for one purpose, to create a memorial to Hamilton and to the role he played in the establishment of the nation. The alterations that have taken place since then fall into two groups: the major ones done when the Grange was moved in 1888-1889, and the relatively minor ones done at other times.

Current preservation philosophy favors the retention of many types of alterations, even ones made long after a structure was built. However, the alterations of 1888-1889 changed the entire appearance of the Grange, severely compromising its integrity as Hamilton knew it. Therefore, these alterations should be reversed completely.

The remaining alterations are less serious. The most visible of these is the partitioning of the original large north second-floor room into four smaller spaces. The physical evidence suggests that this was done by Hamilton's widow. A case therefore could be made for keeping the partitions. However, these walls alter substantially the use of this area as Hamilton experienced it. Apparently it was a fairly formal room, perhaps a family living room where Hamilton entertained close friends with his piano-playing and daughter Angelica's singing (Mongin, p. 48). The retention of the partitions would impede visitors' understanding of Hamilton's life at the Grange, and so should be removed, after proper documentation.

All of the other alterations seem to have been made by later owners. While they do not seriously impair comprehension of the Grange as Hamilton knew it, they do detract from the "feel" of the original structure, and so should be removed as well.

*

*

*

During the course of this work, it is inevitable that details of the historical fabric will be destroyed. For example, original nails will be lost, and original finishes and construction details damaged. To mitigate the serious and irreversible nature of the changes to be made, an ongoing photographic and written record should be kept of the process of restoration.

B. Summary of Recent Work

The Architectural Data Section of this report was begun in 1977, in response to the severe deterioration of the Grange's exterior at that time. As explained in the introduction to the Architectural Data Section (p. 94), the rehabilitation work deemed necessary was divided into two phases. Phase I was to consist of the immediate attention needed to stabilize the exterior of the building on its present site. It also would include cosmetic work on the interior. It would not include the restoration of elements — such as the rear portico — that could not be reintroduced to the Grange in its present, cramped position. Phase II was to encompass the relocation of the Grange to a larger site, the remaining interior work, and a full interior restoration. However, it was thought wise to develop an alternative course of action, in the event that economic or other factors made relocation impossible. This was labeled "Alternative Phase II."

Phase I was carried out in 1978-1979 (see Appendix K). The external deterioration proved to be so extensive that the "stabilization" turned into a rather complete restoration of the Grange's exterior to its historical appearance. The only major element not accorded full treatment was the main roof. Although neither its form nor covering material was historically correct, it was in good condition, and so was retained and repaired. The interior cosmetic work was not performed. However, new fire- and intrusion-detection systems were installed during the winter of 1980-1981.

Some progress has also been made on Phase II activities. In 1980, the New York City firm of Meadows/Woll Architects prepared a feasibility study for the moving of the Grange to a more auspicious site. This is excerpted as Appendix L.

The following sections outline what work remains to be done in all areas.

C. Phase I: Stabilization

Although most of the work intended for completion during Phase I was accomplished in 1978-1979, a number of items were omitted, chiefly for economic reasons. Work that remains to be done is as follows.

Exterior

Walls. The north and south basement walls should be repaired and pargeted, as was done with the west and east walls in 1978-1979. The north and south subbasement walls should be repaired and repointed. Sealant should be used along both of the subbasement walls to close the joint between the wall and the alley floor, to keep out rainwater. (See Appendix K, Sheet 2.) The rubblestone east wall at subbasement level, which supports the east gallery and east piazza, also should be repaired and repointed.

Doors. The basement doors in the east and west elevations should be removed. The paneled doors in each doorway should be repaired and rehung, as per Appendix K, Sheets 3 and 20.

Stairs. New handrails should be fabricated for the stair descending to the west-elevation basement areaway. They should be detailed according to Appendix K, Sheet 13. Brownstone flagging should be laid on a concrete pad beneath the lower end of the east-elevation stair (see Appendix K, Sheet 2). The brownstone steps in the rear part of the Grange's backyard -- seen in the same drawing -- should be reconditioned as well as possible.

Lighting. An outdoor light should be installed above the east-elevation stairs.

Shutters. Copies of extant Grange hardware were ordered as part of the 1978-1979 restoration work, to replace missing or broken pieces of hardware -- chiefly from the shutters of the second-floor windows on the east and west elevations. Most of this hardware has been finished, and is stored at the site. The remainder should be completed, and the hardware used to rehang all shutters on the upper east and west elevations.

Drainage. Drainage should be improved by the addition of the following, as indicated in Appendix K, Sheet 2:

- 1) a four inch-thick layer of gravel covered with sod, installed in the area around the southeast and northeast corner of the east piazza's foundation
- 2) one poured-in-place concrete splashblock on top of each gravel and sod area, to serve the downspouts here
- 3) topsoil and sod as needed to repair eroded areas of the backyard

A false leader boot also should be mounted on the northwest corner of the west piazza, as per Appendix K, Sheet 3.

Interior

The work here should be confined to safety considerations and basic cosmetic repairs. As long as there is the possibility that the Grange will be moved to a larger site, it would be impractical to do a great deal of work that might be damaged during such a move.

Plumbing. The fixtures in the second-floor bathroom should be removed, and their pipes capped off. These would have to come out in any Hamilton-era restoration, and their absence would make relocation easier. It is not necessary to patch the floor at this time. (The fixtures in both the second-floor bathroom and the northwest-corner basement bathroom were removed in 1979-1980.)

Electrical. All but a few strategically located wall outlets should be removed, and the fuse capacity of the panel box reduced accordingly. The wiring should be examined, and unsafe situations corrected. Whenever walls are opened for any reason, conduit should be installed to facilitate future electrical improvements — especially new service to the attic and the appropriate apportionment of current among the few remaining outlets.

Storage. The architectural artifacts stored in the subbasement, north of the eastern chimney foundation, should be set upon a raised plywood platform and covered with a tarpaulin on a frame, for better protection.

Decoration. Rooms should be cleaned, repaired, and painted as required using the colors specified in Chapter IV.

D. Phase II: Relocation and Restoration

Site Selection and Moving Operation

Several possible relocation sites have been considered over the years, but none has been decided upon at this time. The ideal location for the Grange, from a purely historical point of view, would be its original site, which is about 300 feet northwest of the present one. However, this location is now occupied by inhabited buildings, so it must be eliminated from consideration as a possible relocation site. The characteristics that should be sought for in a relocation site include the following:

- 1) a position within the boundaries of the original Hamilton estate
- 2) ample room to orient the house facing the southwest, as was done originally; to reconstruct the porches properly; to landscape the property appropriately, including the planting of 13 gum trees and a circular flower bed; and to park at least eight automobiles
- 3) proximity to the present location of the Grange, to hold down moving costs
- 4) an absence of tall buildings in the immediate vicinity, to promote a feeling of openness
- 5) a relatively level site, so that the reconstructed cellar story will be properly visible
- 6) a fairly minimal value for any buildings already upon the site

Two studies have been prepared concerning the feasibility of moving the Grange to a larger site and restoring it completely. The first was done in 1962, shortly after the National Park Service acquired the building, by Keally and Patterson, Architects, and Seelye, Stevenson, Value, and Knecht, Engineers. Several possible relocation sites were studied by this report. Its basic conclusion was that the Grange would probably have to be cut in half to be moved. A copy of this study is stored in File #6 of the Superintendent of Manhattan Sites files in Federal Hall, New York City.

A second study was conducted in 1980 by Meadows/Woll Architects of New York City. This report was predicated upon the idea that the Grange would be moved to a site one block west of the present one. The general theme of this study was that it would be physically and economically feasible to move the Grange intact to the new site, but that the new site would still be too small and hemmed-in for the Grange to be presented properly. The cost of moving the Grange to this site and its restoration would be about \$2.2 million, presuming that the Grange did not have to be lifted over the porch of St. Luke's Church. Copies of this study are filed with the Superintendent of Manhattan Sites and at the North Atlantic Regional Office of the National Park Service. Especially relevant portions are excerpted here as Appendix L.

Because the Meadows/Woll study was based upon the idea of using a site found to be unacceptable, it cannot be regarded as a blueprint for future relocation. Many of its observations and conclusions still would be applicable, however, if another site were chosen. Even the material pertaining specifically to the unacceptable site would be useful in this event, if only to bring up the types of questions that must be considered.

Exterior Restoration

Foundation. The Grange should be relocated upon a one-story cellar partially above grade, as the old photographs indicate was the case historically. A modern subbasement should be built below this replica cellar, to house the necessary mechanical systems.

The 1980 Meadows/Woll study (Appendix L, pp. 39-41) tells how the new cellar story should be built up under the Grange while it remains on its moving platform. Foundation walls can be of modern masonry, because their exposed portions should be covered with a parget penciled to match that seen in the old photographs. The east and west walls should incorporate bay-shaped protrusions beneath the bay windows of the first-floor walls.

In terms of windows, the south wall would have two windows aligned with the two windows of the first floor above them. The east and west walls would have windows that echoed exactly the placement of the windows along the piazzas. The north wall would have two windows, one below each of the two outermost windows of the five-bay, first-floor facade. Illustration 34 indicates that the shutters originally on all of these windows may have had two recessed, unmolded panels per leaf. Illustration 38 also provides information.

The space under the piazzas should be kept open, as was done originally, so that the windows can light the cellar. There is no evidence that the windows under the piazzas doubled as doors, however. Therefore, a rear door should be built into the center of the rear (north) elevation, on the basis of the evidence in Illustration 41.

Finally, a subbasement will be needed to house the necessary modern mechanical systems. It may also have to house a Visitors' Center, if the relocation site is not large enough to accommodate a separate building for this function. In either event, at least one outside door will be needed within the subbasement. This can be placed wherever it can be concealed best.

Roofs and Balustrades. The present copper main roof should be taken off, and the framing of the upper part of the roof -- the portion above the rectangular timber frame in the attic -- should be dismantled. Careful attention should be paid during this process, in an attempt to discover more evidence about the original roofing and flashing materials, and about the age of the eaves balustrades seen in the old photographs. A flat deck should be framed in between the timbers of the rectangular frame, using the empty mortise holes as guides for the beams and joists. If no evidence of another original roofing material is found, the lower part of the roof should be covered with split wooden shingles having a four and one half-inch weather, based upon the nail patterns remaining in the sheathing boards. The flat deck should

be covered with an approximation of tinsplate, which is thought to be the original material. The likely choice would be pans of terne-coated stainless steel; these were used in 1978-1979 upon the restored piazza roofs, which also seem to have been covered with tinsplate originally. The pans should measure 10 by 13 inches — a more historically correct size than the 11 by 14-inch dimensions of the piazzas' pans. Joists should not be soldered continuously, but rather touch-soldered at the corners; they can then be filled with a sealant, as was done originally. White-lead putty would have been the original sealant, but a more effective modern material should be used for the restoration. The terne-coated stainless pans should be painted with the same red Tin-o-lin paint used on the piazza roofs (see Chapter IV). The original flashing apparently was solid lead, but terne-coated stainless would again be a sensible substitute. Porch roofs should be treated similarly when reroofing is needed.

Unless clear evidence is found for the originality of the eaves balustrades seen in the old photographs, they should be considered contemporaneous with the raising of the roofs that occurred after Hamilton ownership. The chief reason for this is that the original shed roofs of the piazzas would have been almost impossible to balustrade, whereas the raised, hipped roofs would have been simple to balustrade. Since the main roof and portico roofs' balustrades look to be the same type as that used on the piazzas, it is thought that they all were put up at the same time. If the balustrades are found to be original, they should be reproduced according to the drawings done in 1933 by Wakefield Worcester (Appendix F), unless better-documented drawings are found.

Chimneys. The operative chimneys and all four caps are in good condition, thanks to the work of 1978-1979. However, the original covering of the false stacks needs to be restored. Metal sheeting seems to have been a late 19th-century introduction. The original treatment probably would have been painting to resemble brick (see Chapter IV). Examination of the original board cladding, still in place, could probably provide additional data. Working stacks should be painted like brick work.

Entablature and Gutter System. The entablature is in excellent condition, having been restored extensively in 1978-1979. The original gutter system of the main roof also was restored, and new leaders of terne-coated steel introduced. (The old photographs suggest that the original leader material was lead.) The only question that was not resolved was whether or not the original piazza and portico roofs had gutters, and if so, what form they displayed. The sheathing of the walls of the main block, where the original porch roofs intersected them, would be the best place to look for such evidence.

Just before the Grange is resited, the leaders should be removed. After the relocation, they should be rehung upon the main block according to the old photographs, insofar as proper drainage will permit: at each corner, on the north and south elevations. If it is determined that the porches had gutters originally, their leaders probably would have been located where the later system's leaders were: at each outside corner of the piazzas, on the east and west elevations; and at each outside corner of the south entry portico. Apparently, the north portico did not have later gutters. It therefore probably did not have them originally, either, no matter what is found out about the other three porches.

The earliest photographs of the west piazza (Ills. 34, 35) show its later leaders as being located at the southwest corner; halfway along the length of the piazza; and at the northeast corner next to the house. This is at variance both with the contemporaneous leaders of the east piazza and sound drainage procedures. (Water should be carried away from house walls, not toward them.) Later photographs show this problem corrected, with the leaders' positions conforming to those of the east piazza's leaders.

Siding and Trim. These elements will need no restoration, except whatever repairs must be made as a consequence of the move.

Porches. The east and west piazzas were restored as much as possible in 1978-1979 to their historical form, insofar as the current site would permit. When the Grange is moved to a larger, level site, the restoration of these porches can be completed. This would include the fabrication of a new underpinning system for the east piazza. It also would include the re-creation of the truncated southwest corner of the west piazza, and the removal of the present portico centered along that piazza's outer edge.

The underpinning of the east piazza should replicate that of the west piazza, in which each porch column is supported by one square wooden post resting on a sandstone (brownstone) block. These posts and blocks are seen in the old photographs, so at least the blocks apparently were brought over from the original site and reused. The sandstone probably came from the general vicinity, so sources in New York and New Jersey should be checked in an attempt to obtain the same type of sandstone blocks for the new east-piazza underpinning.

After the portico is removed from the west elevation, the west piazza can be restored properly. The missing southwest corner should be reconstructed, using a reproduction column made like the adjacent ones of 1978-1979. That corner, and the gap left by the removed portico, should be infilled with reproduction balustrading, again made like the adjacent balustrading of 1978-1979.

The west portico also was restored as much as possible in 1978-1979, but a considerable amount of work remains to be done. Determination must be made of the portico roof's original form and pitch, and of the originality of the eaves balustrade seen upon it in the old photographs. There is some indication that the roofs of both front and rear porticoes were raised c. 1835, when the piazzas' roofs were. Like them, they may have been converted from shed roofs to hipped roofs at that time. The pitch of the front portico's roof would have had to be changed again in 1888-1889, when it was butted up against the west piazza's roof.

The best place to look for evidence of these matters is in the sheathing of the center of the south elevation, and in the framing of the portico roof. This should be done before the portico is returned to its original position on the south elevation. If evidence for a hipped, balustraded roof turns up, the 1933 drawings of Appendix F should be used as guides for reconstruction. If no such evidence shows up, the new portico roofs should be constructed like those of the piazzas — shed roofs displaying a very slight pitch, without an eaves balustrade.

Once the form of the portico's roof has been determined, the west portico and its underpinning — the same posts and blocks as used under the west piazza — should be returned to the center of the south elevation. (The photographs indicate that there was a post under each of the four columns of this porch.) The roof should be rebuilt at the proper slope, and covered with pans of terne-coated stainless steel. (Its original covering was probably tinplate, like the piazza roofs', but terne-coated stainless is an acceptable substitute.) Pans of this material were installed in 1978-1979, but they should not be reused: they are larger than the size of pans that would have been used historically, and they are improperly joined. The proper pan size would be 10 by 13 inches; these should be touch-soldered at the corners and joined with sealant, as on the flat deck. The pans then should be painted with red Tin-o-lin paint.

The stair of the south portico was rebuilt in a relatively correct historical manner in 1978-1979, and it can be transported to the south elevation as well. However, the newel posts were not changed in 1978-1979, and they remain inappropriate. Very close examination of Illustration 33, supposedly the earliest photograph of the Grange, seems to indicate shallowly turned newel posts. A study of exterior-stair newels at houses contemporary with the Grange may help clarify the form seen in the photographs. If all else fails, new newels should be fabricated along general Federal-period stylistic lines.

The missing rear, north portico should be fabricated to resemble the restored south portico in most respects. The roof shape and covering, the columns and balustrading, the stair, and the underpinning should all be the same. (The sandstone for the underpinning can be obtained when the stone for the east piazza's underpinning is purchased.) According to the old photographs, however, the north portico had only one column at each outside corner, and it was slightly smaller than the other portico. Scars upon the north-elevation sheathing will aid in determining its exact dimensions.

Doorways. The front entranceway, with its sidelights, transom light, and flanking pilasters, should be taken out of the south end of the west wall, and returned to its original location in the center of the south elevation. The sidelights should be restored to the form seen in pre-1955 photographs, and still found in the tripartite window on the second floor. One additional, matching pilaster should be applied to the house wall outside of each flanking pilaster, in line with the coupled columns of the outside corners of the portico here. The door and lock can be reused as they are.

The doorway at the north end of the west wall should be removed. Before being discarded, the exterior casing should be checked to make certain that it is not a survivor from the original rear doorway. The nonhistoric door here is a good copy of the original Grange doors, but it is both shorter and narrower than them, and so probably cannot be reused.

The closed-up rear entrance should be reopened, according to the evidence found within the north wall and seen in the old photographs. The photographs indicate that this doorway had neither flanking pilasters nor a transom light. The doorway frame and casing should be a simple form of the front-doorway frame. The door should be a reproduction made specifically for this opening. It should be fitted with the large iron rim lock now stored at Federal Hall.

Windows. The two holes left by the removal of the front and side doorways should be reduced in size to re-create the two double-hung windows originally here. The position and dimensions of the window that will replace the front door will have to be determined by measuring the other first-floor, double-hung windows, since its original framing was lost in 1889. The position and dimensions of the window that will replace the side door will be easier to determine, because the present doorway apparently reused the window's interior casing in situ. Therefore, the doorway's top and side boundaries can be taken for those of the window. The bottom boundary of the window can be deduced from the sill scars seen on the interior side casing members.

After the two windows are framed in and clad around, new casings and sash should be made for them, with forms being copied from other windows. If possible, old glass should be used for the lights.

All of the other window frames and sash should be removed for treatment, except for those of the second-floor east elevation. (These were renewed in 1978-1979.) The wooden members should be conserved with epoxy and wood preservative, and reinstalled. All of the extant panes of glass should be saved and put back into the conserved sash.

Shutters. Based upon hardware and stylistic evidence, all of the first-floor and second-floor double-hung windows that do not already have flush-panel shutters should receive copies of them. Hinges should be reproductions of the remaining strap-type hinges; shutterdogs should be replicas of the unequal-blade type still found upon the Grange. First-floor windows should get shutters that have a solid top panel; these should have the notched-strap and button arrangement to hold them closed. Second-floor windows should receive shutters that have a louvered top panel; these should have the tab and pin combination to secure them.

A special version of the flush-panel shutters should be made for the triple-hung windows. Its top panel would be the same size as the two lower panels, in order to get the additional length needed for these windows. Each leaf should be divided horizontally, between the top and middle panel, and both sections should be hung individually. This will permit the bottom section to be opened while the top section remains closed. It is not certain as to which hinge type and shutterdog form should be used here. However, the strap hinges and the unequal-blade "dogs" would seem to be the most likely choices, since they were used on all other original shutters.

Interior Restoration

Cellar. Because the Grange is the only extant dwelling of the Hamilton family, and one of the very few in New York City of the Federal period, the interior of its cellar must be restored to help visitors understand Hamilton's life at the Grange. The space should be divided up according to the information contained in Chapter III, Section B, "Original Cellar." However, certain investigations should be conducted before the replica cellar is built. The extant chimney stacks should be examined to try to determine which stack served the kitchen fireplace, and which the stew holes. For example, grease stains may remain in the flue of the fireplace. Evidence also should be sought for the idea that the fireplace's stack would have been larger than that of the stew holes, as Newton Bevin suggests in his restoration drawings (Appendix J, Sheet 1). Finally, the underside of the first floor should be studied, in hopes of discovering which center room was occupied by the ironing room and which by the family dining room. (The latter probably would have had a better-finished ceiling than the former.)

All original-appearing material from the present cellar should be saved, including the two entrance doors, closet door, and corner cupboard of the kitchen, and the entrance door of the east center room.

If no evidence to the contrary turns up, the room plan put forth by Bevin can be followed, but the chimney stacks in the cellar should be reconstructed at the same size. The composition of the foundation walls has already been discussed in the section on exterior Phase II restoration. Their interior surfaces should be sheathed with either whitewashed rubblestone — to approximate the original foundation material — or whitewashed brick. The interior partition walls should be of brick, also probably whitewashed. The walls of the family dining room and servant's room might be lathed and plastered. In terms of ceilings, all original lath and plaster should be retained. Any later plaster on original lath should be removed and replaced with plaster formulated to match the old plaster. Areas of later plaster on later lath should be opened up, to look for clues to the original ceiling treatment there. If no clues are evident, lath and plaster should be used in the more important rooms, and whitewash on the exposed floor framing for lesser areas.

Ideally, the new rest rooms that will be required should be located in the subbasement, to minimize modern intrusions into the replica cellar. If they cannot, and must be installed in the replica cellar, the southwest corner would be the most logical place.

Framing and Insulation. The consequences of the 1889-1967 settlement should be addressed before the Grange is moved. There are two options: stabilization and correction. Based upon economic factors and current preservation thinking, the stabilization approach seems preferable. The case for this is made on pages 21-23 of the 1980 Meadows/Woll study (Appendix L). Briefly summarized, this would be the simplest and least destructive approach. The separation and framing members in the attic would be treated by infilling the gaps with blocks and shims, and by lag-bolting steel straps across all. The interior evidence of settlement and racking would be repaired as much as possible without complete structural reworking. Rooms involved here would be the center and northern rooms on each floor.

Full correction of the problem would involve the jacking up of the northern interior bearing partition on each floor, so that the north-south attic timber resting upon this tier of partitions would be pushed back up into contact with its post. The jacking would cause much original plaster to fail, and it might not be completely successful if debris has filled the separations, or if timbers have become permanently warped. It would permit, however, the deflected doorways and separated framing members to be repaired in a historically accurate manner.

No modern insulation should be put in the Grange's walls. To do this properly, a vapor barrier should be installed. Such action would require the removal of either the recently restored exterior wall fabric or the original interior wall plaster, neither of which is acceptable.

Stair Relocation. All of the Grange's various stairways were moved -- with far-reaching consequences -- during the remodeling of 1888-1889. These must be returned to their original locations in order for the Grange that Hamilton knew to be understood.

The present main stair and cellar stair, attic stair and its compartment, and the east wall of the second-floor southwest room -- these should be dismantled. The original pieces of woodwork involved should be saved. These include:

- the hall-side casing and door of the doorway to the second-floor southwest room
- the section of baseboard at the west end of the south wall of the second-floor southeast room
- the baseboard around the present attic-stair compartment in the second-floor east center room
- the top and northern casing members of the doorway to the closet within the attic-stair compartment

The treads and risers of the present main stair may be original; determination of this should be made when they are pulled out.

All of the Victorian trimwork should be removed. This consists of:

- the present entry hall-stair hall cornice
- the baseboard on all entry-hall walls
- the baseboard on the south wall of the stair hall
- the room-side casing of the doorway to the second-floor southwest room
- the casing and door of the doorway to the present attic-stair compartment
- the southern casing member and door of the doorway to the closet within the attic-stair compartment

Using the scars left in the plaster of ceilings and walls as guides, restorers should rebuild the two closet partitions in the southwest corners of each floor. The partition on the first floor should have a doorway located at its north end; that on the second floor should have no doorway, since the closet was reached originally from the west center room. Parallel to the first-floor closet partition, but farther east,

another partition should be built to separate the restored stair hall from the restored center entry hall. This partition also should have a doorway at its northern end.

The main stair should be rebuilt in the area between these two partitions, as per the information in Chapter III, Section C, "Entry and Stair Halls -- Original Form." The treads and risers of the present main stair should be reused if historic. A new balustrade and newel posts will be needed. Research into the woodworking done by Grange builder Ezra Weeks and his family may yield some clues as to what form these should take, but simple Federal forms can be used if no specific information is found.

The cellar stair should be rebuilt below the main stair, again according to Chapter III, Section C, "Entry and Stair Halls -- Original Form." If the stair's treads and risers are found to be original, reused material when they are pulled out, they should be incorporated into the new, reproduction cellar stair.

The attic stair should be reconstructed inside a compartment built along the west wall of the second-floor southeast room, as indicated in Chapter III, Section D, "Southeast Room." The doorway that originally connected this compartment with the original front hall should be reopened. Its position can be determined from the original framing, still inside the southern end of the present wall.

Finally, the 1889 stairwell should be floored over at the second-floor level; the 1889 attic-stair door should be closed up in the east wall of the second-floor center hall; and the 1889 attic-stair hole should be covered over in the ceiling of the east center room.

Second-Floor North-Room Reconstruction. The original large north room -- which was subdivided 1810-1820 into the four smaller spaces found today -- should be re-created. It appears that the area had a specific, interesting function during Hamilton's years at the Grange that is hard to visualize under present conditions. Therefore, the east wall of the northwest room, the west wall of the northeast room, and the south wall of the present bathroom should be removed. The old but nonhistoric cornice on these walls might be saved, although current restoration plans do not call for its reuse. Other elements of the room that need restoration work are treated in other sections "Doorways and Doors," "Windows," "Closets," and "Plasterwork").

Floors. Most of the floors are original and in good condition. The main task here will be to frame in and floor over the present main stairwell at the first- and second-floor levels. The narrow floorboards in the first-floor northwest room and north hall should be removed to expose the original floorboards. These should be restored if possible, or replaced with reproduction boards. The patch in the first-floor northeast room's floor does not need to be replaced. The holes left when the second-floor bathroom's pipes are removed should be filled. Finally, all of the floors should be repaired as needed, cleaned, and protected with some type of dressing.

Doorways and Doors. As seen in the section entitled "Stair Relocation," the restoration of the Grange will involve much doorway work. This is summarized as follows:

- two original doorways should be re-created:
 - in the north end of the replica entry hall-stair hall partition
 - in the north end of the replica stair hall-closet partition on the first floor
- three original doorways should be reopened, with exact positions being determined by evidence remaining in the wall framing:
 - the front doorway, in the center of the south elevation (will require the removal of 1889 infill here)
 - the rear doorway, in place of the window in the first-floor north hall (will require not only the removal of 1889 infill below the window, but also the filling in of the top four inches or so of the present opening, to bring the slightly higher window opening down to door level. No transom light should be installed)
 - the attic stair-compartment doorway, in the south end of the east wall of the second-floor front hall
- two nonhistoric doorways should be closed up:
 - the doorway to the present attic-stair compartment, in the south end of the east wall of the center hall
 - the doorway between the second-floor east center room and the northeast room
- four nonhistoric doorways will disappear when nonhistoric partitions are removed:
 - the doorway to the closet within the present attic-stair compartment
 - the doorways to the two second-floor north corner rooms
 - the doorway to the second-floor bathroom

The casings that will be required for the five restored doorways are described in the "Woodwork" section, below.

In terms of doors, the re-created doorway to the first-floor closet should receive the hall door to the present second-floor southwest room, as mentioned previously. The front entranceway can be fitted with its original door, returned from the west wall. However, the other three doorways will need six-panel reproduction doors. Several reproduction doors will be freed up during the restoration work. These include the present side door, and the doors to the second-floor north corner rooms and bathroom. However, these are smaller than original Grange doors, and probably cannot be reused. Therefore, reproduction doors should be made up for the entry hall-stair hall doorway, the rear outside doorway, and the doorway to the replica attic-stair compartment. The first two should be paneled on both sides, but the latter needs panels on its hall-side only.

The hall door to the second-floor southeast room is original to that location, but it initially was hung to the south jamb, rather than the north jamb used today. Therefore, the door's hinges and lock should be returned to its south stile, and the marks left on the north stile and jamb repaired.

Several other original doorways lack their original doors. Four of the missing doors are stored on the second floor of the Grange. The one labeled "Extra Door #1" should be rehung in the doorway to the first-floor northeast room. "Extra Door #2" should be returned to the west octagon room's doorway to the north hall. "Extra Door #3" and "#4" should be hung in the east octagon room -- in the doorways to the south and north halls, respectively. The original double doors between the two octagon rooms have disappeared completely. As indicated before, the four-paneled doors seen in late 19th-century photographs are not thought to be original. Instead, six-panel leaves should be made -- of double thickness -- and hung on the east side of the jamb. These should have their panels fitted with mirrors on both sides. The doors leading from the octagon rooms to the south and north halls should have their room-side panels treated similarly, but not their hall-side panels.

In terms of hardware, all first-floor doors should receive reproduction steel-case mortise locks with brass escutcheons. The hall doors to the second-floor center rooms, and that to the large north second-floor room, should have the same. These can be copied from the original lock still on the hall door to the west room. All other doors should be fitted with cast-iron rim locks. The rim lock on the door to the second-floor northeast room should be used as a model for their reproduction. Doorknobs should be of brass. Brass handles might be used instead for less-important rooms. If finances permit, the present five-knuckle, steel, fast-joint butt hinges could be replaced with reproduction cast-iron, fast-joint butt hinges. However, since the original hinges probably would have been five-knuckle ones as well, the difference in appearance would not seem worth the expense.

Windows. The two double-hung windows that originally sat where the front and side doors are now will have to be re-created when these doors are moved. The exterior Phase II restoration discussion tells how the replica windows should be framed in and fitted with sash. The interior casings that will be needed for the two windows are described in the "Woodwork" section, below.

Fireplaces and Mantels. The one Grange fireplace that has been closed up -- in the first-floor northwest room -- should be reopened. It should be fitted with a wooden reproduction mantel even simpler than the basic Grange mantel found in the second-floor center rooms. Three other wooden reproduction mantels should be made to replace the marble mantels in the octagon rooms and the first-floor northeast room. The first two should be identical; the third should be slightly simpler. However, all three should be more ornate than the original mantels in the second-floor north corner rooms. They should be designed according to information gathered during the aforementioned research into the Weeks brothers' woodworking, or else made along the lines of the Gracie Mansion mantels (Ill. 22) -- perhaps incorporating the bellflower motif.

When the nonhistoric marble mantels and the various coal grates are removed, the fireboxes should be examined for evidence of the iron firebacks and jambs that McComb specified in his 1801 proposal (p. 29). The ironwork found should be restored; that missing but recalled by evidence should be re-created. Finally, the coal grates removed from the fireplaces of the west octagon room and west center room should not be reinstalled.

Closets. The re-creation of the two large southwest closets on the first and second floors has already been discussed in the "Stairs" section of this chapter. The c.-1889 closet in the second-floor northwest room should be taken out; that within the present attic-stair compartment will disappear — as it should — when the stair is returned to its original position in the second-floor southeast room.

No closet should be built into the northern end of the replica attic-stair compartment in this room, despite Bevin's Restoration Drawings, unless physical evidence can be found that confirms its existence in 1802. Also, the originality of the corner closet missing from the northeast corner of this room should be investigated further. The wall plaster here should be checked for scars, and the corner cupboard in the present basement kitchen should be examined to see if it might have been the one once here. If no conclusive evidence of originality is found, the closet should be assumed to have been nonhistoric, and so should not be re-created.

Woodwork. Nonhistoric woodwork, especially the picture molding, should be removed, and copies of original Grange moldings installed where necessary. The woodwork elements needed for specific restored areas are as follows:

- first-floor, southwest closet:

- *simple baseboard (perhaps Type D)
- *simple casing for east, stair-hall doorway and west window (perhaps simplest Type C)

- first-floor stair hall:

- *simple baseboard (perhaps Type D)
- simplest Type D casing for west, closet doorway (use present hall-side casing of doorway to second-floor southwest room)
- simplest Type D casing for east, entry-hall doorway

- entry hall:

- simpler Type A baseboard (to match that on east wall)
- simpler Type B casing for west, stair-hall doorway

- west octagon room:

- fancier Type B baseboard on either side of the wooden reproduction mantel

- east octagon room:

- fancier Type A baseboard on either side of the wooden reproduction mantel, and where the door to the northeast room was closed up

- first-floor northwest room:

- *simple baseboard (necessary only if extant trim is not original)

- repairs to the west window's casing (install reproduction sill and apron)
*simple mantel
- first-floor north hall:
 - repairs to the casing here (rework extant window trim to fit reopened doorway)
- second-floor, southwest closet:
 - *simple baseboard (perhaps Type D)
- second-floor front hall:
 - fancier Type C baseboard (to match that on north wall)
 - simplest Type D casing for doorway to attic stair (use top and north members of present east center room's closet-doorway casing)
 - apron molding below tripartite window (profile should be based upon other pieces of window's casing; width will be dictated by the amount of room left after present stairwell is floored over)
- second-floor southeast room:
 - simpler Type C baseboard on attic stair-compartment walls
 - repairs to top member of hall doorway casing (remove patch when attic stair-compartment is rebuilt)
- second-floor center hall:
 - fancier Type C baseboard where 1889 attic-stair doorway was closed up
- east center room:
 - simpler Type C baseboard where 1889 attic-stair compartment was removed, and where door to northeast room was closed up
 - edge molding of fancier Type D casing for north window's casing (to replace later edge molding)
- north room:
 - repairs to areas of baseboard where partitions were removed, if necessary
 - repair of present bathroom's window casing (install reproduction sill and apron, and extend side pieces to floor to make "panel")

* The moldings marked with an asterisk are those whose exact form is uncertain.

Plasterwork. This project can be divided into three categories: the complete plastering of reconstructed partition walls; the repair of areas altered during restoration or damaged prior to that time; and the repair and installation of plaster cornices.

The areas that will need complete replastering will be the two entry-hall and stair-hall partitions on the first floor, and the walls of the attic-stair compartment in the second-floor southeast room.

The rooms in need of plaster repairs consist of every room except the southeast room on each floor. Most of the afflicted rooms will require only the patching of wall and ceiling cracks. However, extensive infill will be needed around reconstructed doors and windows. The door and window work that should be done, and the infill plastering that each opening will require, is as follows:

- the reopening of the front door, which will require the removal of wall plaster in the center of the south elevation
- the re-creation of the window where the front door is now, which will require plaster infill all around the reconstructed window framing
- the reopening of the rear doorway, which will require the removal of plaster below the window now in the first-floor north hall, and the addition of plaster in the top part of the present opening, to bring it down to door level
- the re-creation of the window where the side door is now, which will require the addition of plaster below the reinstalled sill

The areas that will require cornice repairs are the octagon rooms, where damage has occurred, and the second-floor north rooms, where nonhistoric partitions will be removed. (The cornice of the first-floor southeast room should be examined and its originality confirmed as part of this work.) Two places will require new plaster cornices. The first-floor stair hall should get one modeled along the lines of the cornice in the first-floor north hall which is of similar importance, while the entry hall should receive one somewhat similar to the cornice in the adjacent entry-hall apse. Like the original cornices, these should not be run in place, but rather fabricated and attached with nails.

Interior Fixtures. Fixtures should be designed to approximate as closely as possible the historic lighting equipment. They should include electrified oil lamps and electric, wax-covered candles. The present 1930's fixtures (Ill. 84) might be reused, if their "candle" portions can be made to look more realistic. If they are not reused, they should be kept and stored, as a record of an earlier restoration effort.

Furnishings Study and Plan. A furnishings study should be conducted for the Grange, based upon documentary research and physical information found during the course of the restoration work. Ideally, this study should be done during the restoration campaign, because both activities are interdependent. The physical work will yield evidence for the study, which in turn will make recommendations that should be implemented as part of the restoration work. For example, when the 1810-1820 partitions are removed, the original floor finish of the large north room can be determined; this will influence the treatment of Grange floors in general.

Mechanical Systems

Heating and Cooling. Although the present gas-fired, steam-radiator system is in good condition, it is inadequate for proper heating. Therefore, a complete remodeling of the Grange's heating system will be necessary. As mentioned in the recommendations concerning the cellar, a subbasement should be built below the relocation site to contain the necessary mechanical systems. A larger, gas-fired, hot-water boiler should be installed in the subbasement. The c.-1933 radiators should be removed. Pipes should be installed to carry the hot water to fan-coil air handlers in the attic and cellar. These units will use the hot water to heat air, which can be vented into individual rooms through the fireplaces. Provisions for humidification of this air should be included. Dehumidification and central air conditioning will not be needed, since the New York climate is not that hot and humid. For additional information, see Appendix L, pp. 44-46.

Water and Sewer. When the cellar is re-created, c.-1802 pipes should be reproduced to carry water away from the kitchen sink and to the sink, if research shows that this would have been plausible historically.

Concerning toilet facilities, the pipes remaining from the second-floor bathroom taken out during Phase I should be removed. New rest rooms should be constructed either in the cellar, and concealed, or else put into the subbasement, as part of the Visitors' Center. Wherever they are located, the bathrooms should be accessible to the handicapped. Again, see Appendix L, page 44.

Electricity. The outlets retained during Phase I should be made as unobtrusive as possible, perhaps by relocating them in the floor. The present 150-ampere service is sufficient, but the interior should be completely rewired, including entirely new service to the attic, and to the replica cellar and new subbasement. Outside lights should be installed for adequate security. See Appendix L, page 46.

Security. Motion-detection sensors now protect the basement of the Grange, but such sensors also should be installed upon the upper two floors after the Grange is restored and outfitted as a museum.

E. Alternative Phase II

If the Grange is not relocated to a larger site, several of the exterior Phase II recommendations will have to be foregone. However, the remaining work can be carried out, as well as most of the interior recommendations.

Exterior Restoration

The primary exterior project that cannot be carried out on the current site is the restoration of the front and rear entry porticos. The front portico should be recorded and disassembled, and stored for possible future restoration. The exterior recommendations that can be implemented on the present site include the lowering and reroofing of the main roof, the return of the front and rear doorways to their original positions, the removal of the west-elevation side door, the complete restoration of the west piazza, and the re-creation of windows lost when they were converted into doors. The pans of the piazza roofs should be replaced with smaller ones (10 by 13 inches) when replacement is needed.

Interior Restoration

Nearly everything specified as Phase II interior work can still be accomplished on the current site. The present subbasement can be remodeled to hold the new utility systems and the Visitors' Center. It would be entered from the east side of the building, via a door in the rubblestone wall beneath the east gallery. In the Visitors' Center, a model could be displayed to illustrate the original exterior orientation and appearance of the Grange. The present basement should be remodeled to approximate the original cellar. The first and second floors can be restored as indicated for Phase II.

VII. BIBLIOGRAPHY

A. Primary Sources

Manuscripts

Alexander Hamilton Papers. Bank of New York.

Alexander Hamilton Papers. Library of Congress.

American Scenic and Historic Preservation Society archive and correspondence files.

Candee, Richard M. "Materials Toward a History of Housepaints: The Materials and Craft of the Housepainter in Eighteenth Century America." A thesis submitted to the Faculty of the State University of New York at Oneonta at its Cooperstown Graduate Programs in partial fulfillment of the requirements for the degree of Master of Arts, May 1965.

Index of American Design. Avery Architectural Library, Columbia University.

James Kent Papers. Library of Congress.

Morrison, John H. "Chain of Title." American Scenic and Historic Preservation Society.

New York City Department of Buildings. Plans files.

New York County Recorder. Land records.

Papers of Alexander Hamilton Publication Project. Butler Library, Columbia University. Chronological notebooks of documents.

Penn, Theodore Z. "Decorative and Protective Finishes, 1750-1850: Materials, Process, and Craft." A thesis submitted to the Faculty of the University of Delaware in partial fulfillment of the requirements for the degree of Master of Arts in History, June 1966.

Schuyler, Philip. Account Book, 1756-1798. New York Public Library Manuscript Collection.

Stillman, S. Damie. "Artistry and Skill in the Architecture of John McComb, Jr." A thesis submitted to the Faculty of the University of Delaware in partial fulfillment of the requirements for the degree of Master of Arts, June 1956.

_____. "The Sources of the Adam Style." Ph.D. dissertation, Columbia University Faculty of Philosophy, 1961.

Ward, John, Jr. Diary. New-York Historical Society Manuscript Collection.

Published Documents

Goebel, Julius, Jr., ed. The Law Practice of Alexander Hamilton: Documents and Commentary. Vol. 1. N.Y.: Columbia Univ. Press, 1964.

Hamilton, Allan M. Recollections of an Alienist. N.Y.: George H. Doran Co., 1916.

Hamilton, James A. Reminiscences. N.Y.: Charles Scribner & Co., 1869.

King, Charles R., ed. The Life and Correspondence of Rufus King. Six vols. N.Y.: G.P. Putnam's Sons, 1894-1900.

Stokes, I.N. Phelps. The Iconography of Manhattan Island. Six vols. N.Y.: Robert H. Dodd, 1915-1928.

Ware, W.R., ed. The Georgian Period. 12 parts in 3 vols. N.Y.: American Architect, 1898-1908.

B. Secondary Sources

Books

American Scenic and Historic Preservation Society. Annual Report for 1901, 1902, 1905, 1906, 1907, 1909, 1912, 1913, 1914, 1916, 1925.

American Society of Landscape Architects. Colonial Gardens: The Landscape Architecture of George Washington's Time. Wash., D.C.: U.S. George Washington Bicentennial Comm., 1932.

[Andrews, Kenneth] Dr. Hosack's Garden. N.Y.: Rockefeller Center [1938].

Becker, Carl L. The History of Political Parties in the Province of New York, 1760-1776. Madison: Univ. of Wisconsin Press, 1960, pb.

Bliven, Bruce, Jr. Battle for Manhattan. N.Y.: Henry Holt and Co., 1956.

Bolton, Reginald P. Washington Heights Manhattan: Its Eventful Past. N.Y.: privately printed, 1924.

Brown, Sanborn C., ed. The Collected Works of Count Rumford. Vol. 2. Cambridge, Mass.: 1969.

Chamberlin, Samuel. Salem Interiors. N.Y.: [n.d.].

-----, Portsmouth, New Hampshire: A Camera Impression. N.Y.: [n.d.].

- , Open House in New England, p. 48. New York: 1937.
- Congden, Herbert W. Old Vermont Houses, 1763-1850. Revised ed. Peterborough, N.H.: 1968.
- Cunningham, Anna K. Schuyler Mansion a Critical Catalogue of the Furnishings & Decorations. Albany: New York State Education Department, 1955.
- Curate. St. Luke's History. N.Y.: privately printed [c. 1935].
- Essex Institute. Samuel McIntire - A Bicentennial Symposium 1757-1957. Salem, Mass.: 1957.
- Gottesman, Rita, comp. The Arts and Crafts in New York. 3 vols. New York.
- Hamilton, Alexander. Works. 10 vols.
- Hall, Edward H. Philipse Manor Hall at Yonkers, N.Y. Second ed. N.Y.: American Scenic and Historical Preservation Society, 1925.
- Hamilton, Allan M. The Intimate Life of Alexander Hamilton. N.Y.: George H. Doran Co., 1916.
- Hamlin, Talbot F. The American Spirit in Architecture. New Haven: Yale Univ. Press, 1926.
- , House Plan Books Prior to 1890 in the Avery Library. N.Y.: Columbia University, 1938.
- Historic American Buildings Survey. Historic Buildings of Massachusetts. N.Y.: 1976.
- Humphreys, Mary G. Catherine Schuyler. N.Y.: Charles Scribner's Sons, 1897.
- Isham, Norman M., and Brown, Albert F. Early Connecticut Houses. N.Y.: Dover ed., 1965.
- Larkin, Oliver W. Art and Life in America. N.Y.: Rinehart & Company, 1949.
- McIntosh, John G. The Manufacture of Varnishes, Oil Crushing, Refining and Boiling and Kindred Industries. London: Scott, Greenwood and Co., 1899.
- Myers, Denys P., ed. Maine Catalog. Augusta: 1974.
- Mitchell, Broadus. Alexander Hamilton: The National Adventure, 1788-1804. N.Y.: The Macmillan Company, 1962.
- , Alexander Hamilton: Youth to Maturity, 1755-1788. N.Y.: The Macmillan Company, 1957.
- Morris, Richard B., ed. Alexander Hamilton and the Founding of the Nation. N.Y.: The Dial Press, 1957.

Peterson, Charles E., annot. The Rules of Work of the Carpenters Company of the City and County of Philadelphia. Phila.: Carpenters Company of the City and County of Philadelphia, 1786, reprinted 1971.

Pierce, Carl. New Harlem Past and Present. N.Y.: New Harlem Publishing Co. [c. 1903].

Pierson, William H., Jr. American Buildings and Their Architects. Vol. I: The Colonial and Neoclassical Styles. Garden City, N.Y.: 1970.

Powell, John H. Bring Out Your Dead: The Great Plague of Yellow Fever in Philadelphia in 1793. Phila.: Univ. of Pennsylvania Press, 1949.

Roberts, Kenneth and Anna M., trans. and ed. Moreau de St. Mery's American Journey 1793-1798. Garden City, N.Y.: 1947.

Roosevelt, Theodore. Gouverneur Morris. Boston & N.Y.: Houghton, Mifflin and Co., 1888.

Rothery, Agnes. Houses Virginians Have Loved. N.Y.: Rinehart & Co., Inc., 1954.

Schachner, Nathan. Alexander Hamilton. N.Y.: Thomas Yoseloff, 1946, 1957.

Schuyler, Georgina. The Schuyler Mansion at Albany. N.Y.: DeVinne Press, 1911.

Shelton, William H. The Jumel Mansion. Boston: Houghton Mifflin Co., 1906.

Sonn, Albert H. Early American Wrought Iron. 3 vols. N.Y.: 1928.

Swiggett, Howard. The Extraordinary Mr. Morris. N.Y.: Doubleday & Co., 1952.

Tuttle, Mrs. H. Crosswell. History of Saint Luke's Church in the City of New York 1820-1920. N.Y.: Appeal Printing Co., 1926.

Ulmann, Albert. A Landmark History of New York. N.Y.: D. Appelton and Company, 1901.

University of the State of New York. Historic Sites of New York State. Albany: The University of the State of New York, 1961.

van Norden, Warner. The Fatness of Thy House. N.Y.: privately printed, 1953.

Vrooman, John J. Historic and Scientific Sites of New York State. Albany: New York State Education Department.

Articles

American Scenic and Historic Preservation Society. "The Building of the House." Thirtieth Annual Report (1925).

———. "Hamilton's Purchase of the Farm." Thirtieth Annual Report (1925).

———. Scenic and Historic America, Vol. I, No. 3 (Sept. 1929) and No. 5 (Sept. 1929 [sic]); Vol. IV, No. 4 (1937).

———. "Two Old Pictures of Hamilton Grange," Scenic and Historic America, Vol. III, No. 1 (Mar. 1931).

Belknap, Prescott. "The Hamilton Duel." Illustrated American, Apr. 23, 1892, pp. 467-468.

Berton, Gene. "Hamilton Grange Today." The Mentor, XVII, July 1929, pp. 36-37.

Carter, James C. "Hamilton." Homes of American Statesmen.

"A Federal Tragedy in New York." Antiques, Vol. 72, July 1957, p. 54.

Fowler, Lemuel. "Some Forgotten Farmhouses on Manhattan Island." The White Pine Series of Architectural Monographs, IX, No. 1 (Feb. 1923), pp. 3-14.

"Geneology of the Ward Family." New York Geneological and Biographical Record, Vol. VI, No. 3.

Gregg, C.E. "General Philip Schuyler and the Schuyler Mansion." Yearbook of the Dutch Settlers Society of Albany, 1949-1951, Vols. XXV-XXVI, pp. 11-19.

"Hamilton's Thirteen Trees." Illustrated American, April 23, 1892, pp. 465-467.

"Hamilton's Trees--Fatal Duel with Burr Recalled." Bankers' Magazine, LXXXV, No. 3 (Sept. 1912), pp. 318-320.

Hamlin, Talbot F. "John McComb." Dictionary of American Bibliography, vol. XI.

Hill, Robert W. "The Robert Troup Papers." New York Public Library Bulletin, Vol. 37, No. 7 (July 1933), pp. 574-576.

Klein, Claire. "Columbia and the Elgin Botanic Garden Property." Columbia University Quarterly, XXXI, No. 4 (Dec. 1939), pp. 272-297.

Lamb, Martha J. "General Grant's Resting Place, It's [sic] Historic Associations." Magazine of American History, XIV, No. 3 (Sept. 1885), pp. 225-248.

-----, "Historic Homes and Landmarks: Their Significance and Present Condition." Magazine of American History, XXI, No. 1 (Jan. 1889), pp. 1-23.

Mayer, Josephine, and East, Robert A. "The Settlement of Alexander Hamilton's Debts: A Footnote to History." New York History, XVIII, No. 4 (Oct. 1937), pp. 378-385.

"Men Who Built New York—5. John McComb, Jr." House & Garden, July 1934, pp. 8h, 8j.

Meyer, G.R. "Roofing with Wood Shingles." Old House Journal, Vol. V, No. 8 (Aug. 1977).

Nelson, Lee H. "Nail Chronology as an Aid to Dating Old Buildings." Technical Leaflet No. 48. Revised ed. Nashville, Tenn.: American Association for State and Local History, 1968.

"New Year's Day in 1861." New-York Historical Society Quarterly Bulletin, Vol. XXVIII (1944), p. 21.

"The Original Plans of the City Hall, New York City, Drawn in 1802, John McComb, Jr. Architect." American Architect and Building News, XCIII, No. 1676 (Feb. 5, 1908), pp. 43-46.

Preble, Edward. "David Hosack." Dictionary of American Biography, Vol. IX.

Pumpeilly, Joseph C. "Alexander Hamilton and the Grange." Americana, VII (Nov. 1912), pp. 1007-1024.

"Reminiscences of Mrs. Alexander Hamilton." Atlantic Monthly, LXXVIII, No. CCCCLXVI (Aug. 1896), pp. 282-284.

Schafer, Joseph. "High Society in Pioneer Wisconsin." The Wisconsin Magazine of History, XX, No. 4 (June 1937), pp. 447-461.

Streeter, Donald. "Early American Wrought Iron Hardware: Cross Garnet, Side, and Dovetail Hinges." Bulletin of the Association for Preservation Technology, Vol. VI, No. 2 (1974), pp. 6-23.

-----, "Early American Wrought Iron Hardware: Hand HL Hinges, Together with Mention of Dovetails and Cast Iron Butt Hinges." Bulletin of the Association for Preservation Technology, Vol. V, No. 1 (1973), pp. 22-49.

-----, "English Iron Rim Locks, Late 18th and Early 19th Century Forms." Bulletin of the Association for Preservation Technology, Vol. VI, No. 1 (1974), pp. 40-67.

-----, "Some Signed American Iron Rim Locks." Bulletin of the Association for Preservation Technology, Vol. V, No. 2 (1973), pp. 9-37.

Sutherland, R.W. "Hamilton Statue Dominates New Site at Historic Museum." The Crescent, XX, No. 5 (Sept. 1936), pp. 19, 24.

Ten Broeck, Dirck. "The Last Hours of Hamilton." The Historical Magazine and Notes and Queries, VI, No. 6 (June 1862), pp. 176-177.

Torrey, Raymond. "Hamilton Grange." Scenic and Historic America, Vol. III, No. 3 (April 1934).

VanDerpool, James G. "A Restoration Problem at Hamilton Grange." Columbia Library Columns, IV, No. 2 (Feb. 1955), pp. 11-23, 19-20.

Whicher, George M. "On Mr. Partridge's Statue of Hamilton." Review of Reviews (American Ed.), VIII (July-Dec. 1893), p. 641.

Wilde, Edward S. "John McComb, Jr., Architect." The American Architect and Building News, XCIV, No. 1703 (Aug. 12, 1908), pp. 49-53; No. 1704 (Aug. 19, 1908), pp. 57-63.

Newspapers

Brooklyn Daily Eagle. "Alexander Hamilton Takes a Walk." July 13, 1936.

Evening Sun. "Historic Tree Must be Felled." July 18, 1912.

The Home News. "Noted Alexander Hamilton Statue Comes Uptown." July 16, 1936.

Kilmarnock Standard. "Kerelaw House" (Historic Keeps and Castles and Stately Homes of Ayrshire...), C.H.W. Apr. 5, 1924.

New York Evening Post. "In Memory of Hamilton" (editorial). Apr. 17, 1929.

New York Herald. "Park Commissioner Will Urge Purchase of Hamilton Grange." Mar. 1, 1912.

New York Herald Tribune. "Collingwood, Mrs. Helen A." (obituary). Jan. 23, 1949.

New York Times. "Gets Hamilton Relics." Aug. 13, 1936.

-----, "Hamilton Grange Becomes Memorial" Nov. 18, 1924.

-----, "Hamilton's Home Becomes Museum." June 20, 1933.

-----, "Hamilton's Home is to be Turned into Museum." Nov. 23, 1924.

-----, "Statue to be Dedicated." Oct. 18, 1936.

_____. "The Tour de Force of Redecorating Boscobel." Rita Reif. July 21, 1977.

_____. "Tower -- Storer." Nov. 16, 1924.

[unknown]. "Ghosts of the Grange." George A. Townsend. [c. Oct. 10, 1886].

[unknown]. "Hamilton Grange." Oct. 19, 1872, pp. 436-438.

Reports

American Scenic and Historic Preservation Society. Two Hundredth Anniversary of Alexander Hamilton, 1757-1957. The Grange Relocation and Restoration. N.Y.: American Scenic and Historic Preservation Society, [c. 1957].

Bevin, Newton P. Historic Structures Report, Part II, Architectural Data Section on Restoration of Hamilton Grange. Eastern Office of Design and Construction, Division of Architecture, National Park Service, Apr. 1964.

Dorman, Charles G. "Furnishing Plan for Hamilton Grange," with three introductory chapters by Alfred Mongin. Aug. 1964.

Hobbs, William H. The Configuration of the Rock Floor of Greater New York. U.S. Geological Survey, Department of the Interior, Bulletin No. 270. Wash., D.C.: U.S. Government Printing Office, 1905.

Mongin, Alfred. "Furnishings Plan, Hamilton Grange, Sections a, b, and c." Nov. 18, 1963.

_____. Historic Structures Report, Part I, Hamilton Grange, Historical Data Section. N.Y.: Federal Hall National Memorial, June 1963.

_____. Historic Structures Report, Part I, Hamilton Grange, Historical Data Section. N.Y.: Federal Hall National Memorial, Sept. 30, 1963; revised Oct. 17, 1963.

New York City Landmarks Preservation Commission. Report on 315 Washington St. House, May 13, 1969, #2, LP-0551. Report on 316 Washington St. House, May 13, 1969, #3, LP-0552.

Ronalds, Francis S. "Report on the Grange, Home of Alexander Hamilton." Memorandum from Superintendent, Morristown National Historical Park, to Ronald F. Lee, Chief of Interpretation, Northeast Region, June 4, 1954. Copy in File #19, Superintendent of Manhattan Sites files, Federal Hall.

Souder, Norman M. Historic Structures Report, Part I, Architectural Data Section on Restoration of Hamilton Grange. Eastern Office of Design and Construction, Division of Architecture, National Park Service, May 1964. Copy in File #19, Superintendent of Manhattan Sites files, Federal Hall.

New York City Directories

Elliot, William. Elliot & Crissy's New-York Directory for the Year 1812.

Jones, John F. Jones's New-York Mercantile and General Directory [for 1805].

Langdon, John. John Langdon and Son's New-York City Directory from May 1, 1804 to May 1, 1805.

Long, George, for Thomas N. Stanford. Citizens Directory & Strangers Guide for 1814.

Longworth, David, ed. Longworth's American Almanac, New-York Register, and City Directory [for 1801, 1802, 1803, 1804, and 1805].

Trow's New York City Directory. Vol. XCIX, for the years ending May 1, 1886, 1888, 1889, and 1891.

Valentine, D.T. Manual of the Corporation of the City of New York for 1858. N.Y.: D.T. Valentine, 1858.

Other

American Scenic and Historic Preservation Society. Minutes of monthly meetings of board of trustees for the years 1924-1943; 1951-1955; and 1959.

Mongin, Alfred. Card file compiled chronologically of information used during preparation of historical data section of Hamilton Grange historic structure report.

Superintendent of Manhattan Sites files, Federal Hall National Memorial, New York City. Files no. 1, 2, 6 and 14.

VII. APPENDICES

Appendix A

Chronology of Construction and Physical Change

- July 17, 1800 Letter from Philip Schuyler to A. Hamilton requesting "bill of scantling" for preparation of the timber
- August 2, 1800 Hamilton acquires Schieffelin property
- August 25, 1800 Letter from Philip Schuyler to A. Hamilton suggesting use of bricks in walls of Hamilton's new house to "prevent the nuisance occasioned by rats and mice." Also suggests solid wooden partition walls, rather than walls of lath and plaster on joists. Gutters also originally of wood
- October 4, 1801 Letter from A. to E. Hamilton in regard to ventilating and shingling the ice house on property
- June 22, 1802 Proposal from John McComb, Jr., architect of the Grange, for finish work on the house
- 1802 Miscellaneous bills for house paints (possibly for buildings other than the Grange), boards, joists, shingles, "fan and sidelights"
- 1803 Bill from John McComb for extras, which mentions cool cellar, ash house, "necessary house," milk house, and "inrichments for cornice"
- 1803 Letter from P. Schuyler to E. Hamilton describing loss of paint and oil for new house
- July 1804 Hamilton killed in duel with Aaron Burr
- December 1804 Hamilton house and estate on market
- 1810-1820 Second-floor north room divided up
- 1833-1845 Grange owned by two speculators, no known documentation from this period
- 1845-1876 Grange serves as summer home for family of William G. Ward
- 1854 Description of house, by James C. Carter in his Homes of American Statesmen, notes original location of main stairway, describes mirrored doors connecting two octagon rooms, confirms that cellar contained the kitchen
- 1864 First extant photo of house, raised roof and balustrades evident

- 1879-1886 Owned by William DeForest. Wooden mantels removed from two octagon rooms and possibly first-floor northeast room, and installed in DeForest's New York City apartments. Mirrors also may have been removed at this time
- 1886 Newspaper reporter George Townsend reports repapering of octagon rooms and removal of mantel to DeForest's "City Mansion." Exterior of house described as "dingy yellow" and needing paint
- 1870-1899 Photographs show metal leaders. South elevation has solid, equal-panel shutters on the first floor, louvered shutters on the second floor. Partially louvered shutters on the north elevation and second-floor east and west elevations. South chimneys apparently painted; foundation apparently pargeted and lined to resemble stone. Lower quarter and upper left light of southwest corner front window blocked by interior stair landing
- 1889 Grange relocated on present site with new foundation (old foundation unrecorded except for sketch submitted to New York City Building Department). Piazzas intact, front-door surround (including sidelights) moved from south (original front) to west (new front) elevation. South chimneys sheathed in metal. Inside, main stair relocated, attic stair relocated, mirrors already gone from doors between octagon rooms
- 1889-1892 Various photographs show wood-shingled roof; new newels for portico; north portico removed and doorway replaced with window; and framing exposed where front portico was removed. Building apparently painted, with shutters and house same light color. Photographs of interior show wallpaper in entry hall and east octagon room. Building used as temporary church until completion of St. Luke's new church
- April 20, 1890 New York Daily Tribune reports that "at present the building is undergoing extensive repairs, but its outside appearance will not be altered. On the first floor the two connecting rooms formerly used as a dining room and a reception room are now occupied as a chapel. The large mirrors that formerly lined the walls of the dining room [sic] and reflected the movements of the boats on the Harlem River have been removed"
- 1894 New tinplate roof installed, paid for by the Rev. Tuttle
- 1909 "Whole exterior" painted: subsequent photographs show dark shutters and storm porch at north end of west elevation (presence of current side door probable). Interior "decorated throughout": first floor used as parish house, second floor as rectory
- March 17, 1912 New York Times article (excerpted in annual report of AS&HPS for 1913) states that "Recently these rooms [apparently those of the first floor] have been covered with the wall paper of their period and the woodwork restored to the original Colonial white." Second-floor rooms not redone at that time.

- 1914 Exterior of house painted white, shutters painted green. Most of interior converted into rectory: first-floor north rooms made into kitchen and maid's room. Doors with windows installed to screen octagon rooms from entry and southeast office. Basement fitted up for sexton's family
- November 1924 Grange and property conveyed from St. Luke's Church to American Scenic and Historic Preservation Society
- 1925 Apartment building constructed just north of the Grange. Drawings of first and second floors of Grange done by Edward H. Hall
- 1926 DAR (Washington Heights Chapter) furnishes and uses second-floor west center room as "a colonial living room." Records of AS&HPS show bills for gas and coal, no other major expenditures. During this year Charles Platt, AIA, asked to prepare a restoration plan; plan apparently never done
- 1928 Small repairs done to steps and pillars of east piazza
- 1929 House reroofed with 16-ounce copper sheeting; decayed supports of porch replaced; eaves balustrades removed. Records of AS&HPS state society's intentions to redecorate interior, install new plumbing, lighting, and heating
- 1931 Plumbing repaired (extent not known); some glass in windows apparently replaced
- 1932 House in dingy condition. Report to society describes condition of the house as "deplorable" and suggests urgent need for the installation of central heating and electricity, and additional plastering, painting, and plumbing. Extensive repairs begin, directed by architect A.D. Anstey. Much foundation work done, designed to halt settlement occurring since the 1889 move. Interior plastered and painted. Coal-fired boiler and steam radiators installed; plumbing overhauled. Walk paved with brick; flagpole donated
- 1933-1934 Repairs continue. Outside, "decayed woodwork restored"; new steps and some porch pillars made. West elevation only repainted white. Appraisal done describing the structure in detail. Interior work undertaken with WPA assistance. Electric lighting installed; new "colonial" light fixtures designed by Alexander Hamilton and Alexander M. Welch. Chimneys relined with hollow clay tile
- 1937 One shutter replaced and others repaired. Exterior repainted; interior redecoration discussed, because of cracks in plaster. General carpentry and painting on exterior. Bronze plaque installed

- 1938 Photograph taken at dedication of bronze plaque shows building well painted, with light-colored exterior walls and dark-toned porch
- 1939 Proposal received for painting exterior and chimneys and interiors two or more coats. Work undertaken under the direction of Harvey Stevenson, AIA (firm Seeley, Stevenson, Value, and Knecht), "an authority on pigments used during the Federalist period"
- 1941 Front porch and steps replaced
- 1945-1962 No paint inside or out
- 1953 Severe interior leakage. Society correspondence with bank (trustee for the building) made it clear that ceilings, walls, and woodwork were in terrible condition
- c. 1958 Sidelights of front door destroyed by vandals
- 1962 National Park Service acquires title to the Grange
- 1966 Letter from Newton Bevin, AIA, notes successful repair of roof but otherwise bad condition of building: deteriorating exterior woodwork; brick chimneys in need of recapping; plaster ceiling falling due to leaking; and poor state of steam radiators and cast-iron sectional boiler. He also recommends removing and restoring second-floor shutters; painting new stairs to the east gallery with two coats dark gray paint; removing and replacing the boiler; shoring up sagging timber in boiler room; and removing existing bathroom fixtures and exposed piping
- 1967 New gas-fired boiler and hot-water heater installed; steel beam and lally column introduced in place of sagging timber
- 1968 Paint analysis conducted by Norman M. Souder, AIA
- 1970 Paint color as recommended above ordered and applied (see Chapter IV)
- 1977-78 Research conducted for Architectural Data Section of Historic Structure Report
- 1978-1979 Restoration of Hamilton Grange, Phase I (see Appendix K)
- 1980-81 Fire- and intrusion-detection systems installed

Appendix B

Letter from Philip Schuyler to Elizabeth Hamilton
April 23, 1803

This letter is evidence that Schuyler intended to supply paints as well as lumber for the Grange, and it indicates that the house was painted first in the spring of 1803.

Dear Child: This morning Genr. Ten Broeck informed me that your horses which went from hence were drowned and that you had lost paint, oil, & to a considerable amount, - Supposing this account to have been truly stated to the General, I send you by Toney my waggon horses of which I make you present.

I intended to have your house painted if you cannot recover the paint, purchase no more as I will have the house painted.

When an opportunity offers send my saddle and bridle which Toney will leave.

Your sister united with me in love to you and Eliza.

I am Dr. Child

Your affectionate parent

Ph. Schuyler

Appendix C

Last Will and Testament of Alexander Hamilton*

In the Name of GOD, Amen. I, Alexander Hamilton, of the City of New York, Counsellor at Law, do make this my last Will and Testament, as follows:-

First: I appoint John B. Church, Nicholas Fish and Nathaniel Pendleton, of the City aforesaid, Esquires, to be Executors and Trustees of this my will, and I devise to them, their heirs and assigns, as joint tenants and not as tenants in common, all my estate, real and personal whatsoever and wheresoever, upon trust, at their discretion to sell and dispose of the same at such time and times in such manner and upon such terms as they the survivors and survivor shall think fit, and out of the proceeds to pay all the debts which I shall owe at the time of my death, in whole if the fund shall be sufficient, proportionally if it shall be insufficient, and the rest due, if any there shall be, to pay and deliver to my excellent and dear wife, Elizabeth Hamilton.

Though, if it shall please God to spare my life I may look for a considerable surplus out of my present property — yet if He should speedily call me to the Eternal Work, a forced sale as is usual may possibly render it insufficient to satisfy my debts. I pray God that something may remain for the maintenance and education of my dear wife and children. But should it on the contrary happen that there is not enough for the payment of my debts, I entreat my dear children, if they or any of them shall ever be able, to make up the deficiency. I without hesitation commit to their delicacy a wish which is dictated by my own. Though conscious that I have too far sacrificed the interests of my family to public avocations and on this account have the less claim to burthening my children, yet I trust in magnanimity to appreciate as they ought this my request. In so unfavorable an event of things, the support of their dear Mother with the most respectful and tender attention is a duty all the sacredness of which they will feel. Probably her own patrimonial resources will preserve her from Indigence. But in all situations they are charged to bear in mind that she has been to them the most devoted and best of mothers.--

In Testimony Whereof I have herunto subscribed my hand the ninth day of July in the Year of Our Lord Eighteen Hundred and Four.

[signed:] Alexander Hamilton

Signed, sealed, published & declared as and for his last Will and testament in our presence who have subscribed the same in his presence, the words "John B. Church" being interlined.

[signed:] Dominick F. Blake
[signed:] Graham Newell
[signed:] Theo. B. Valleau.

* AHP, LC.

Appendix D

Trustees of, and Subscribers to, the Hamilton Estate Consortium

Trustees

Morris, Gouveneur
King, Rufus
Benson, Egbert
Wolcott, Oliver
Wilkes, Charles

Subscribers

Astor, John Jacob

Banyar, Goldsbrow, Jr.
Bard, William
Bayard, William
Beekman, John
Benson, Egbert
Boyd, Samuel
Bronson, Isaac
Buchanan, Thomas
Burrell, J.

Cammaun, Charles L.
Church, John B.
Clarkson, Matthew
Clarkson, S. & L.
Cruger, Bert Peter
Cruger, Henry, Sr.
Cruger, Henry N.

Dash, John B., Sr.
Delancey, John
Denning, William

Fish, Nicholas
Fowler, Theodosius
Franklin, John

Gilchrist, Robert
Gouveneur, Samuel
Gracie, Archibald
Griffith, J. & N.

Hammond, Abijah
Harison, Richard
Henderson, William
Hoffman, Josiah Ogden
Hoffman, Martin
Hogan, Michael
Hone, John
Hosack, David
Hunter, John

Jones, Samuel, Jr.

Kemble, Peter
Kibbe, Isaac

Lansing, John, Jr.
Laurance, John
Lawrence, A. H.
Lenox, Robert
LeRoy, Herman
Livingston, Brockholst
Livingston, Philip
Low, Nicholas
Ludlow, Gulian
Lynch, Dominick

McCormick, Daniel
McEvers, J.
McViekar, James
Minturn and Champlin
Morris, James
Morton, Washington

Munro, Peter Jay
Murray, John
Murray, John R., Jr.

Neilson, William

Ogden, David A.
Ogden, Jonathan
Ogden, Samuel G.
Ogden, T. L.

Pearsall, Thomas C.
Pendleton, Nathaniel
Pierpont, Hezekiah B.
Popham, William
Post, Wright

Renwick, William
Rhineland, William
Ricketts, James
Robertson, Gilbert
Rogers, B. W.
Rogers, Henry
Rogers, Moses
Rogers, Nihemiah
Rogers, William

Roosevelt, James
Rutherford, John

Sands, Joshua
Sherrad, Jacob
Stevens, Eben
Stout, Jacob

Taylor, John
Townsend, John
Troup, Robert
Turnbull, George

VanRensselaer, Jeremiah
VanRensselaer, Stephen
Varick, Richard

Waddington, Joshua
Walsh, Dudley
Walton, Gerard
Watson, James
White, Henry
Wilkes, Charles
Winthrop, F. B.
Winthrop, Francis B.
Wolcott, Oliver
Woolsey, William W.

(This list, based on the article by Josephine Mayer and Robert A. East, "The Settlement of Alexander Hamilton's Debts: A Footnote to History," New York History, XVIII, No. 4 (Oct. 1937), 378-385, is the most complete available, but includes only the names of those whose retired certificates are in the files of the Bank of New York, which was the depository of the consortium funds.)

Appendix E

Appraisal of the Grange, November 10, 1933

by A. Edward Lester

for the American Scenic and Historic Preservation Society

DESCRIPTION

A rubble stone, brick and frame

constructed building -

Two story, basement, sub-basement

and attic

Twelve rooms, bath and two toilets

Dimensions - 47' on Convent Avenue,

45' deep

Story heights - Sub-basement 6'6",

Basement 10'

First Story 12'

Second Story 10'

Attic 6' average

Designation of Building -

Alexander Hamilton Grange

Age of Building - 133 years

CONSTRUCTION

	Replacement value	Sound value
<u>Excavation & Foundation</u>		
Excavation for sub-basement and basement area, rubble stone footings	2616.00	
TOTALS, EXCAVATION & FOUNDATION (DEP. 0%)	2616.00	2616.00
<u>Building Construction</u>		
24" rubble stone foundation walls sub-basement		
24" rubble stone basement walls, cement plastered one side		
24" rubble stone interior wall sub-basement		
Concrete floor sub-basement		
Concrete floor in bath and meter room basement		
Two brick chimneys, seven fire places and marble mantels		
Flight of ten 60" concrete steps basement to grade		
Frame brick fill walls above basement, pine studding and novelty siding, plastered interior side		
Frame interior walls and partition plastered two sides		

Replacement
value

Sound
value

Building Construction, Ctd.

Asbestos plaster board ceiling
sub-basement, cement finish,
lath and plastered ceilings
above basement

Tile floor in lavatory

9" "I" beam girders sub-basement,
4" lolly [sic] columns, 8x9" wood
beams

Pine and spruce flooring
throughout, 3x9" joists,
spruce plank flooring second
floor

Plank flooring in attic

Plank roof, 2x7" roof joists,
8x10" beams, 6x6" posts

Frame stairs sub-basement to
second story, mahogany hand
rails and newels

11" wide pine rear porch, 10'6"
high turned columns, basement
floor rear

9' wide pine porch first story
rear, turned columns

10'6" wide front porch, first
story, 10' high turned
columns

Replacement
value

Sound
value

Building Construction, Ctd.

Flight of 8 - 11'6" wide porch
steps, 35" high balustrade
and turned newels, 3x9" joists

Frame hinged windows in sub-
basement, 6 plain glass
lights, wrought iron
exterior guards

Frame double hung windows, plain
and florentine glass lights,
wrought iron exterior guards-
basement

45"x10'6" frame triple hung,
42"x7' frame double hung
windows, 18 and 12 plain glass
lights - first floor

42"x6' frame double hung window,
12 plain glass lights -
second floor

Paneled doors throughout

48"x8' paneled door at first
story entrance, 22" high
glass light transom

Hinged wood shutters on
windows exterior of building

Replacement
value

Sound
value

Building Construction, Ctd.

Cold water painting on walls of
sub-basement

Lead and oil painting on windows,
doors and woodwork and
exterior of building above
basement, porches, etc.

Copper roofing on building and
porches, copper gutters
and leaders

Steam heating plant -

American Radiator Co.
Ideal water tube boiler,
#S-29D-6 - 9 B H series,
coal fired, 5 and 6 tube
cast iron radiators
throughout

Boynton #21002 coal fired hot
water heater, asbestos
covered storage tank

Sanitary plumbing, cast iron
enameled sink in kitchen,
cast iron wash tubs,
vitreous china closet,

	Replacement value	Sound value
<u>Building Construction, Ctd.</u>		
elevated tank, vitreous		
china closets, low down		
tank, cast iron enameled		
bath tub, cast iron		
enameled corner lavatories		
Metal frame wire glass skylight		
Electric lighting throughout		
Plain ceiling lights -		
Sub-basement		
4-light drop fixtures all floors		
3-light drop fixtures, first		
story		
2 6-light crystal chandelier,		
first floor		
Porch light front and rear,		
concealed wiring	44972.00	
	<hr/>	
TOTALS, BUILDING CONSTRUCTION,		
(DEP. 60%)	44972.00	17988.80
	<hr/>	<hr/>
ENTIRE TOTALS, BUILDING		
CONSTRUCTION	47588.00	20604.80
Add 6% Architect's fee	2855.28	1236.29
	<hr/>	<hr/>
GRAND TOTALS, BUILDING		
CONSTRUCTION	50443.28	21841.09
DEPRECIATED INSURABLE VALUE		19225.09

Appendix F

Hamilton Grange: Measured Drawings

City Architects' Emergency Committee, March 2, 1933

These measured drawings of the Grange, dated March 2, 1933, were prepared by architect Wakefield Worcester under the auspices of the New York City Architects' Emergency Committee. The drawings were done in anticipation of the series of sesquicentennial celebrations of the 1930's. They then reposed for many years in the files of the Architectural League of New York. Their existence became known to Alfred Mongin during the summer of 1963. Following his lead, they were found early in 1964 by Eugene McNulty, assistant to consulting architect Newton P. Bevin. The scale model of the Grange now in the Museum of the City of New York was fashioned from these plans. (See New York Times, December 17, 1933.)

The drawings reproduced here, as adapted by the National Park Service from an original set of prints, are numbered one through eight and 10. The existence of a sheet nine is conjectural.

It appears that Worcester arrived at a fairly accurate depiction of the original cellar plan in the same way recent researchers have: by reading McComb's proposal of 1801. His labeling of the cellar rooms is less reliable: he does not include a family dining room, and he seems to have mistaken the term "ironing room" for the term "drawing room."

Hamilton Grange
Prior to 1853. At original site.
Scale: 3/4" equals one foot
- Macmillan drawing -
April 2, 1933.

Attic floor

Second floor

First floor



- North Elevation -

①

- Hamilton Change -
Chosen to 1855 at original site
Scale 1/4" equals one foot
- Measured drawing -
Arch. 2.000.



Attic floor

Second floor

Third floor

Basement floor

- South Elevation -

NO 10

2

MEM-HAGB 9000

Hamilton Garage
 Prior to 1859, of original date.
 Scale 1/4" equals one foot
 — Measured drawing —
 March 2, 1920.

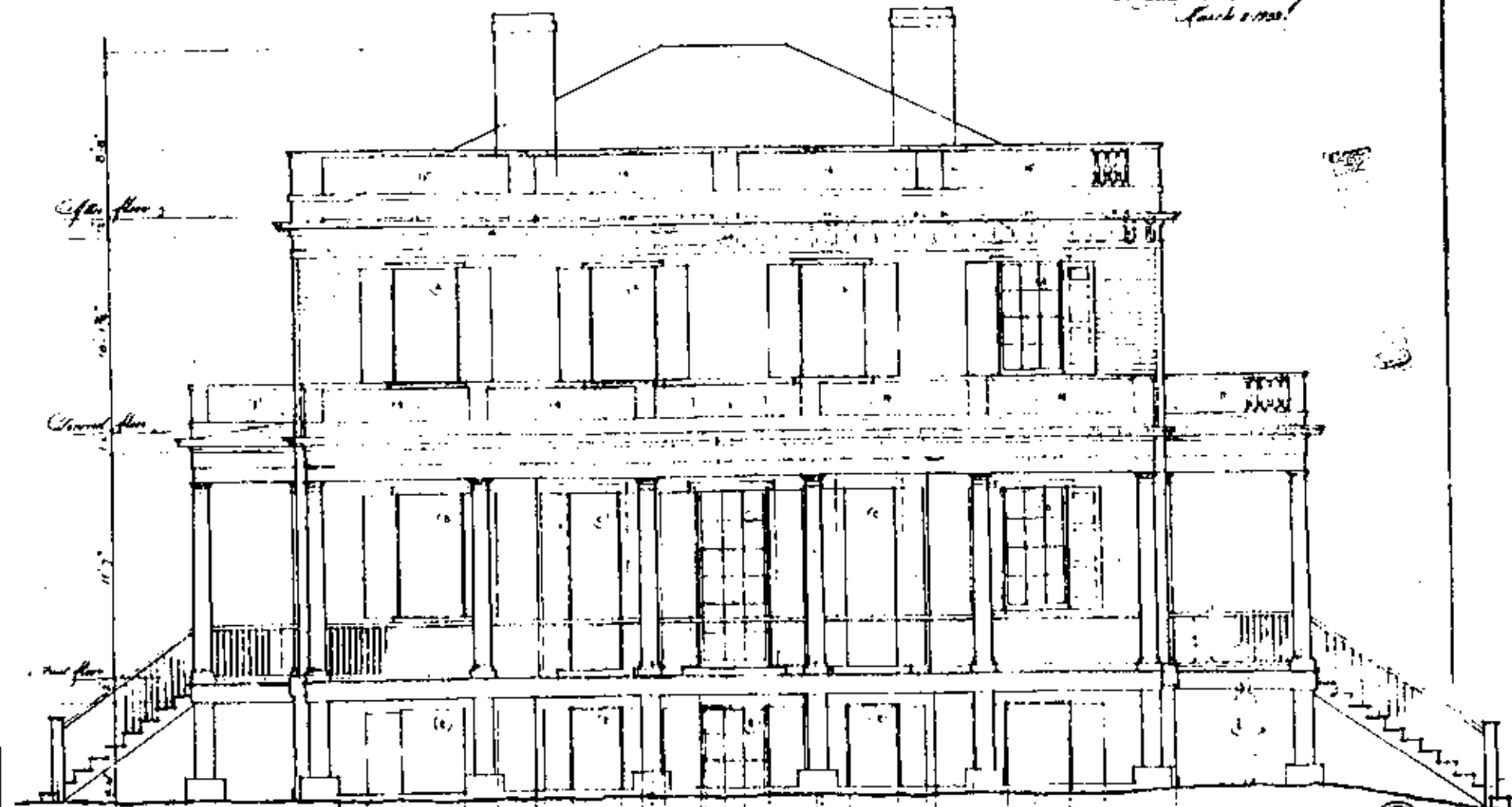

After floor 2

Ground floor

Basement floor

Basement floor

— East and West End of street —

3

NAV-HAGP 3000

- Hamilton Garage -
Plans to 1/8" = 1'-0" on casual site
Scale 1/8" = 1'-0" on face
- Massed drawing -
April 2, 1918.

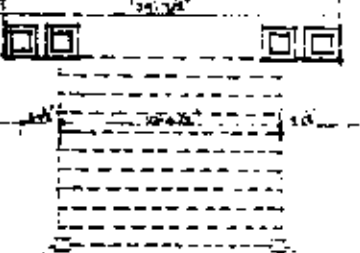
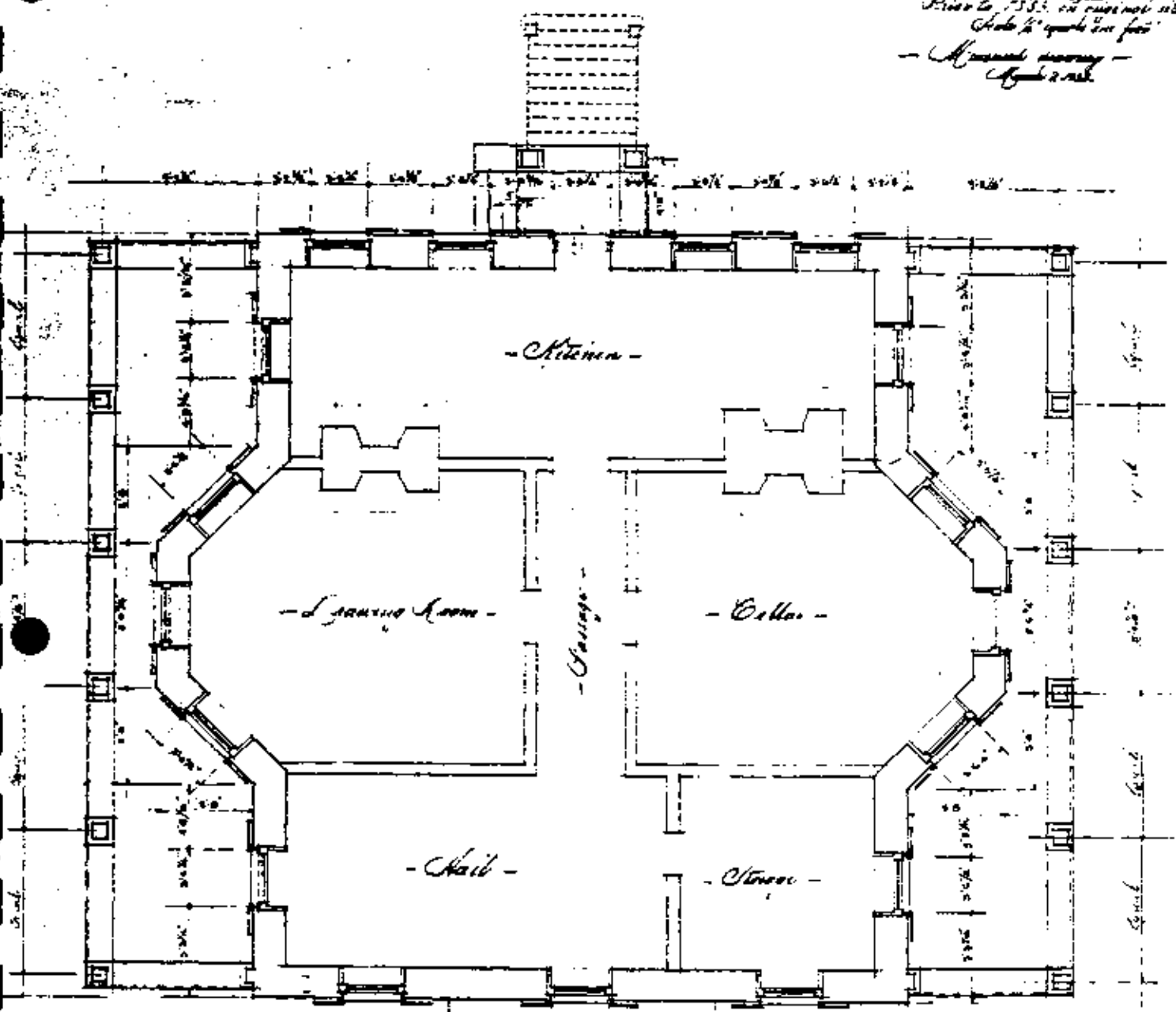

- Basement Plan -

Hamilton Grange -
Plan to 1853, old engraved site
Scale 1/4" equals one foot
A. J. Cassin drawing -
April 2 1915.

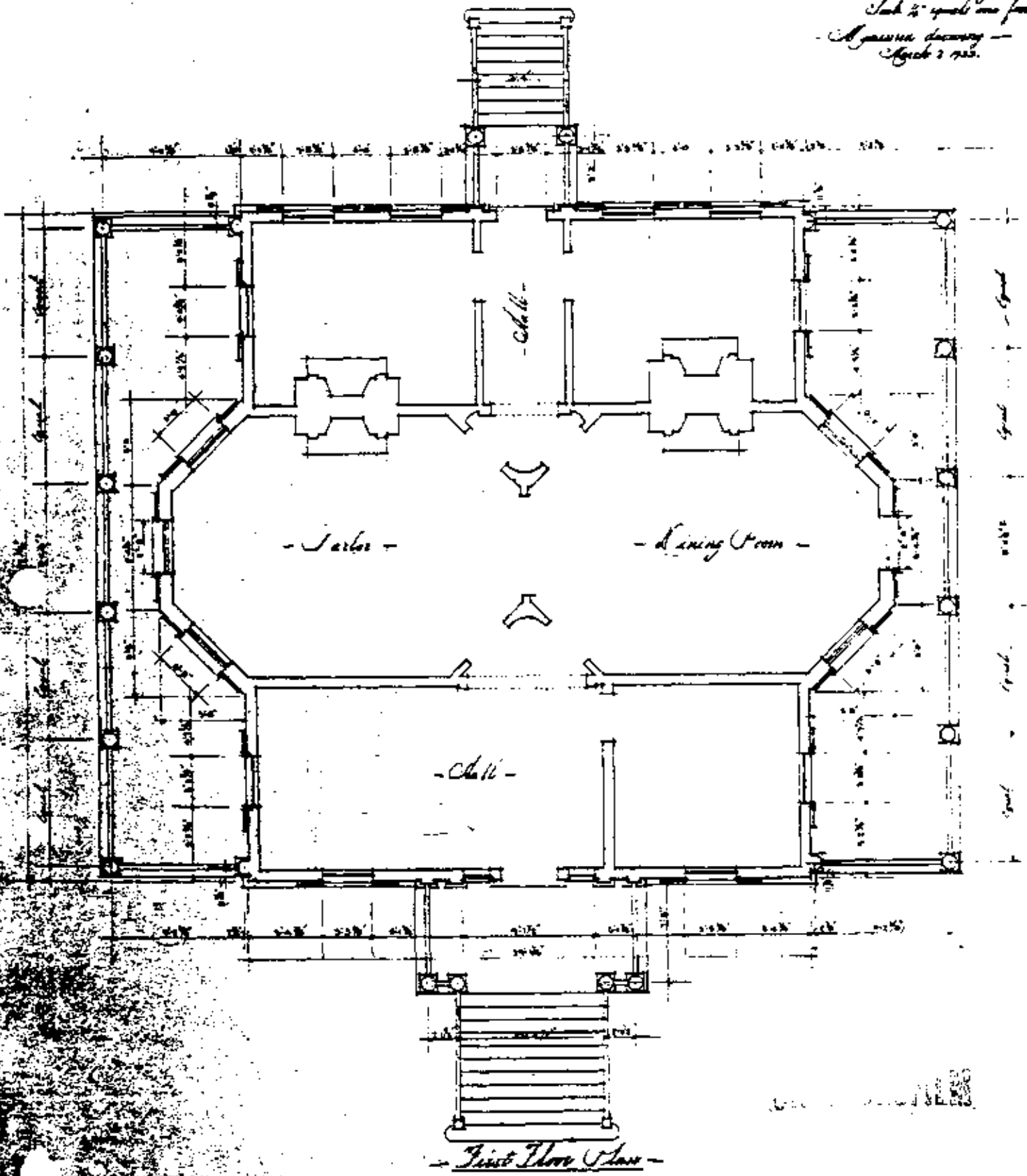

- Hamilton Grange -
Plans to 1887, all measurements
Check to square one foot
- General drawing -
April 2, 1922.

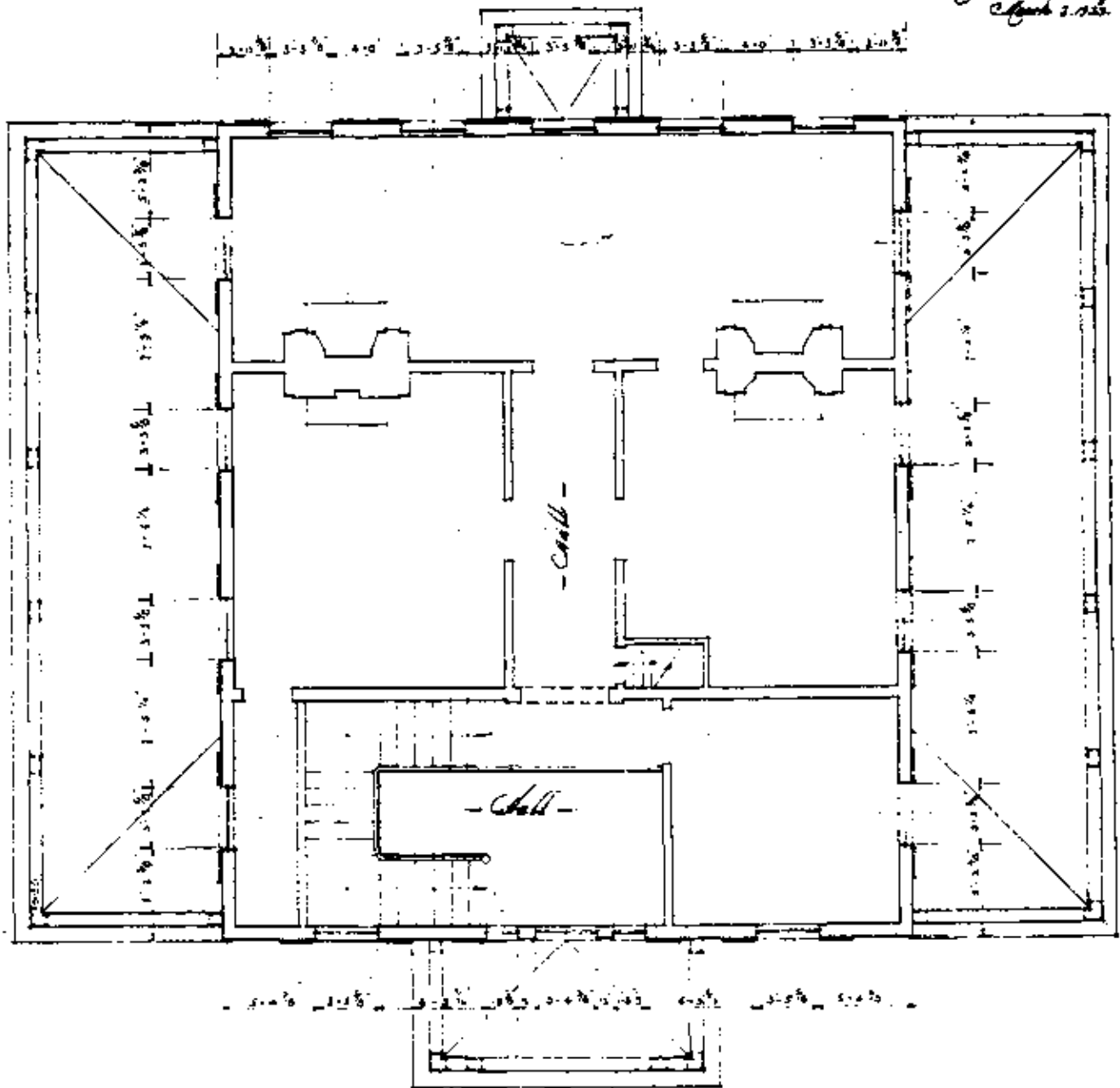

- Second Floor Plan -



N.Y. MAPS 9000

ON MICROFILM

"Hamilton Grange"
*Plan to 1887, all measurements
 Scale 1/4" equals one foot.*
Measured drawing -
April 2, 1928.

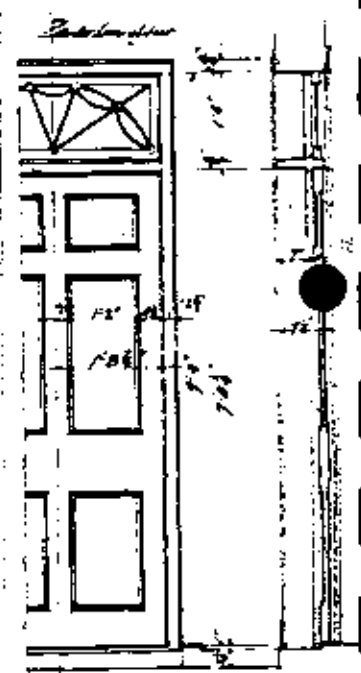
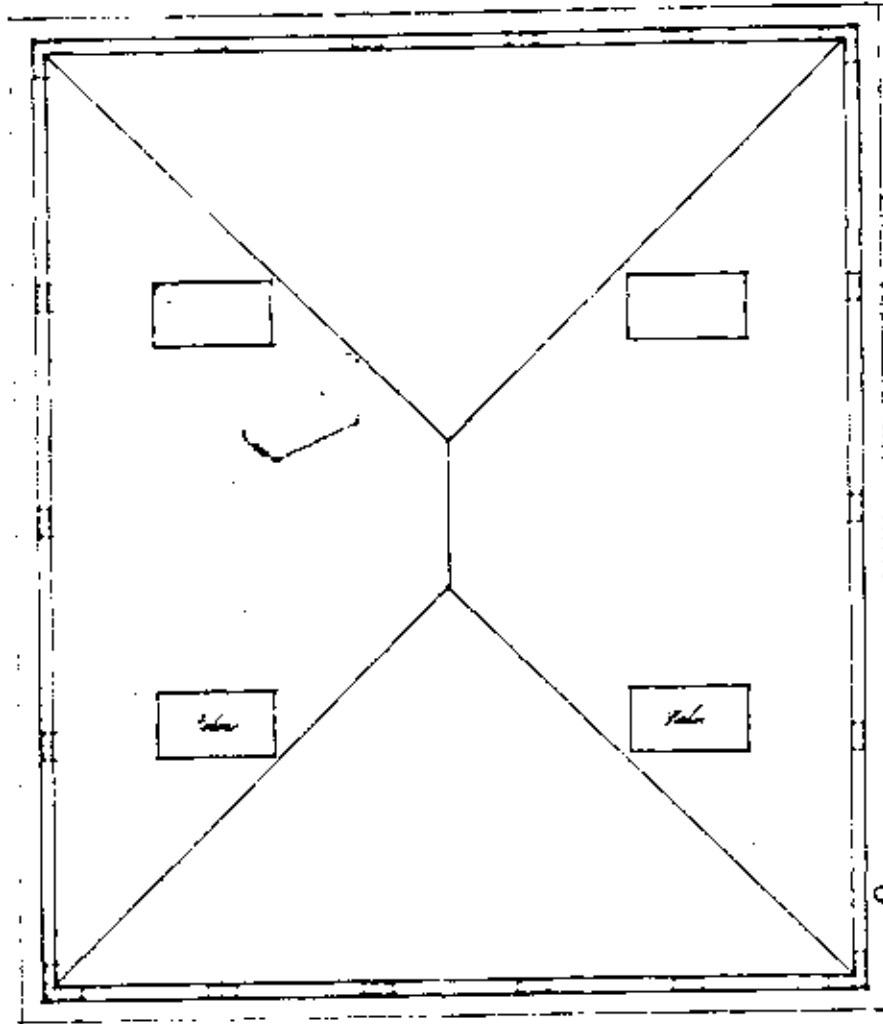

Half Elevation Section
Rear Entrance Door
3/4" x 10"

Half Plan

of Hamilton George
 Plans to 1/8" = 1 foot
 Scale & equals one foot
 Measured drawing
 April 3 1853.

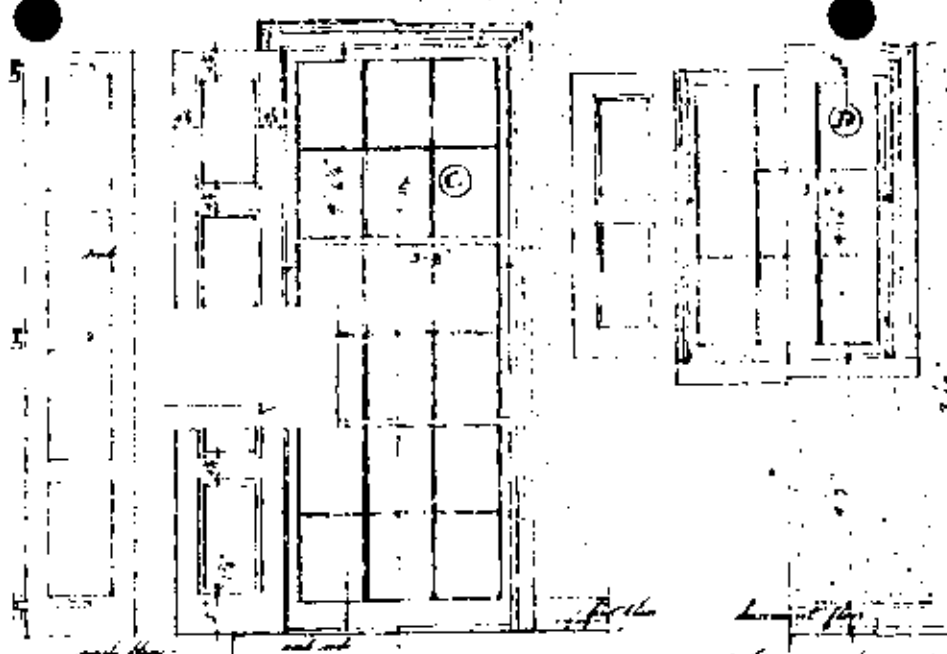

Interior
 Exterior
 First floor windows
 Second windows

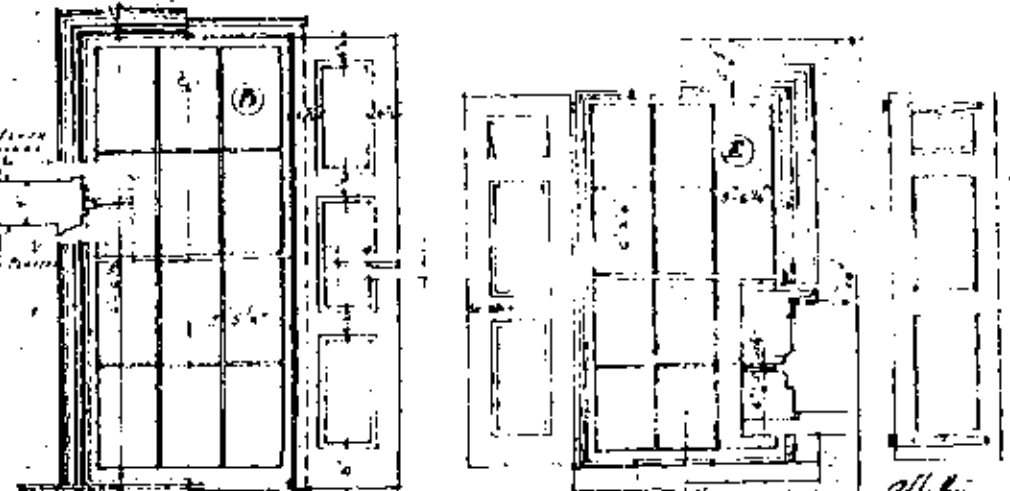
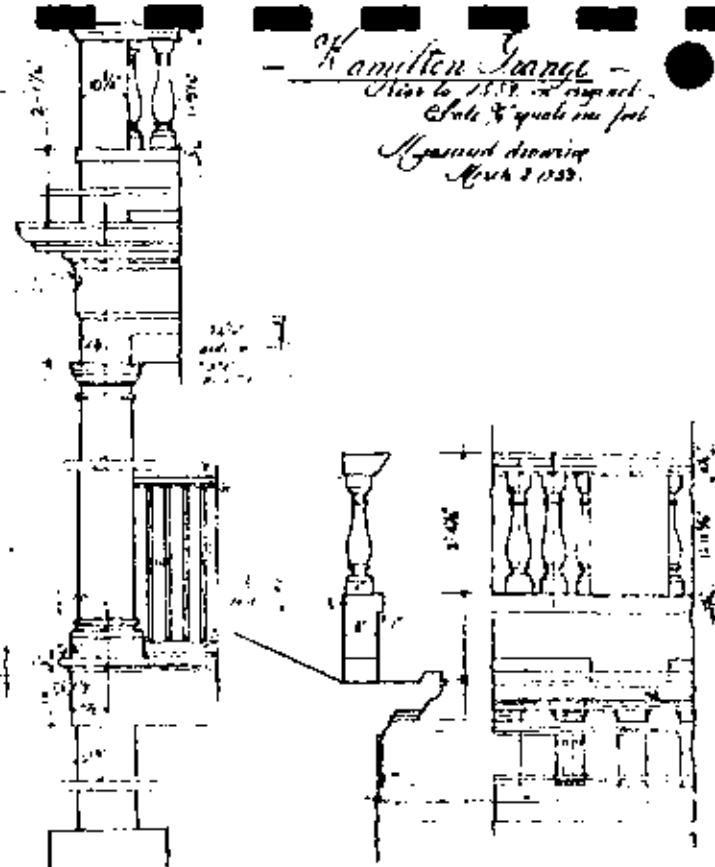

Interior
 Exterior
 First floor windows
 Second windows

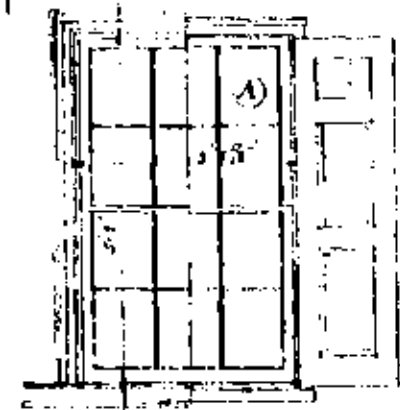

Interior
 Second floor windows

Note:
 Window dimensions as walls exist.



NO 1853

Hamilton Exchange
Drawn to 1/8" = 1'-0" on original
Scale 1/4" equals one foot
Approved drawings
April 2, 1888.

WISCONSIN NO.

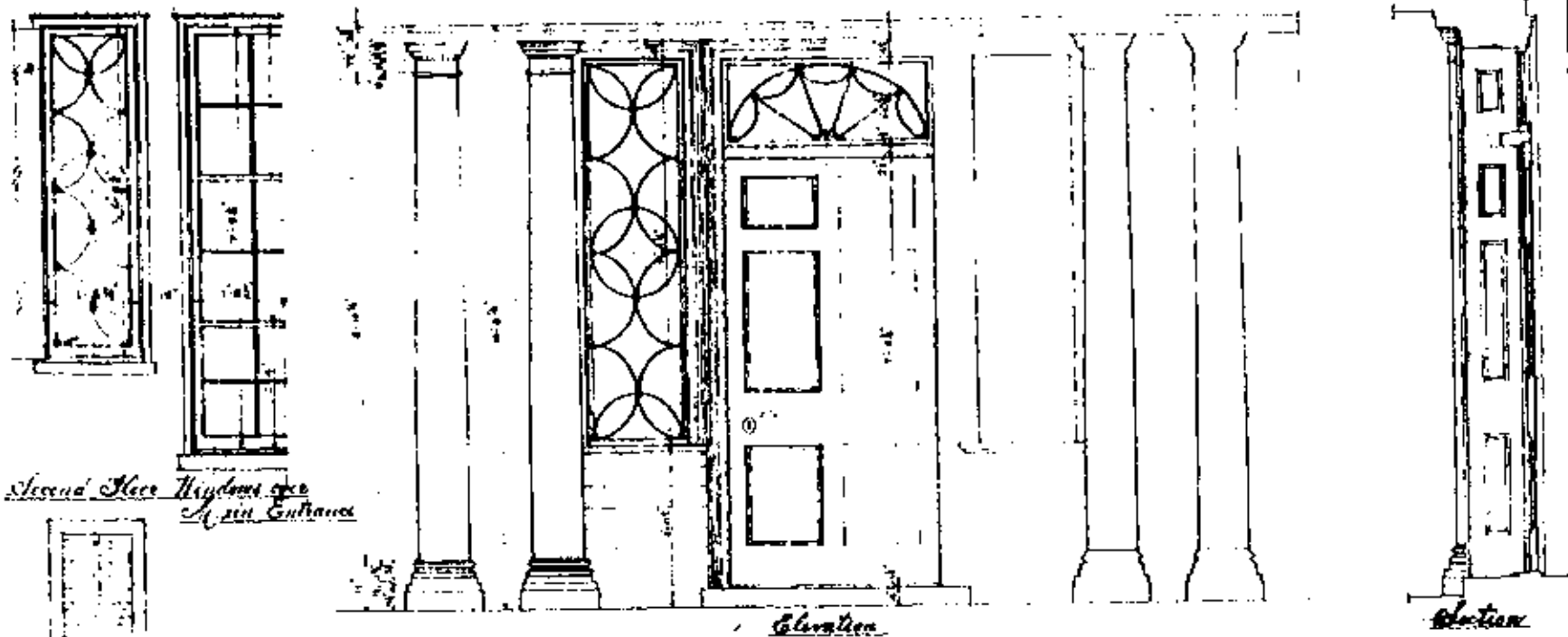

Second Floor Windows open
Main Entrance

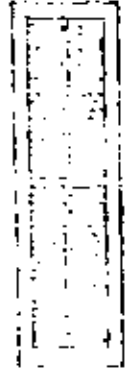

Shutter

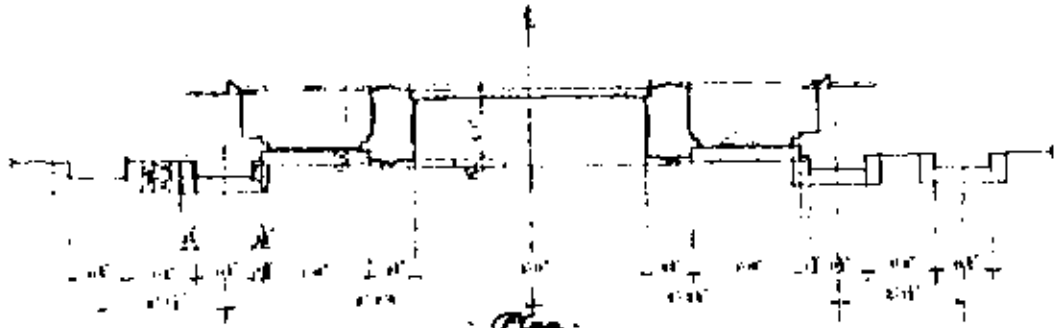

Plan
Front Entrance Details

10

N.M. HARR 2000

Appendix G

Hamilton Grange: Details of Interior Design
Rendered for the Index of American Design
1930's

Filed in the Avery Architectural Library,
Columbia University

1

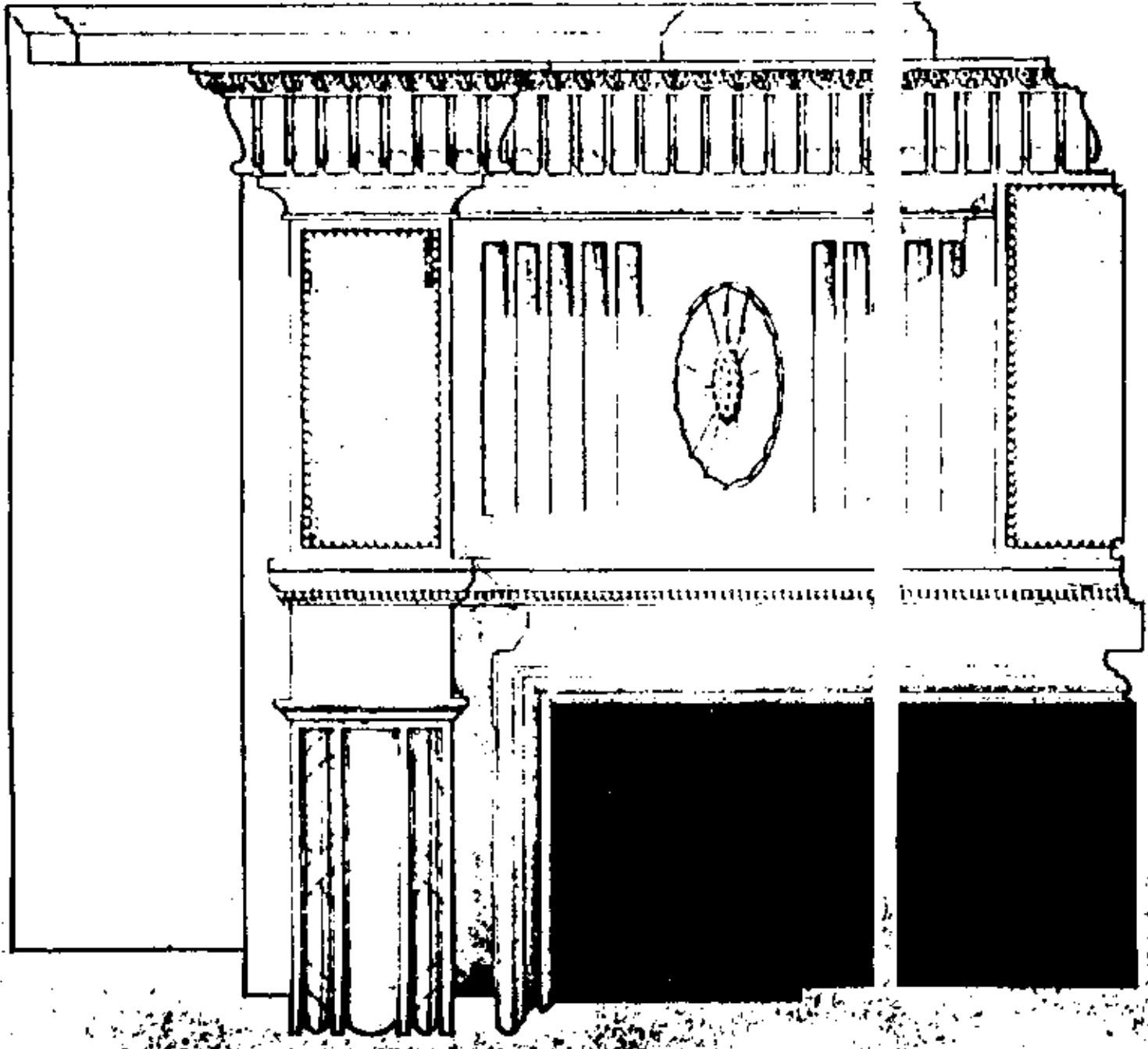

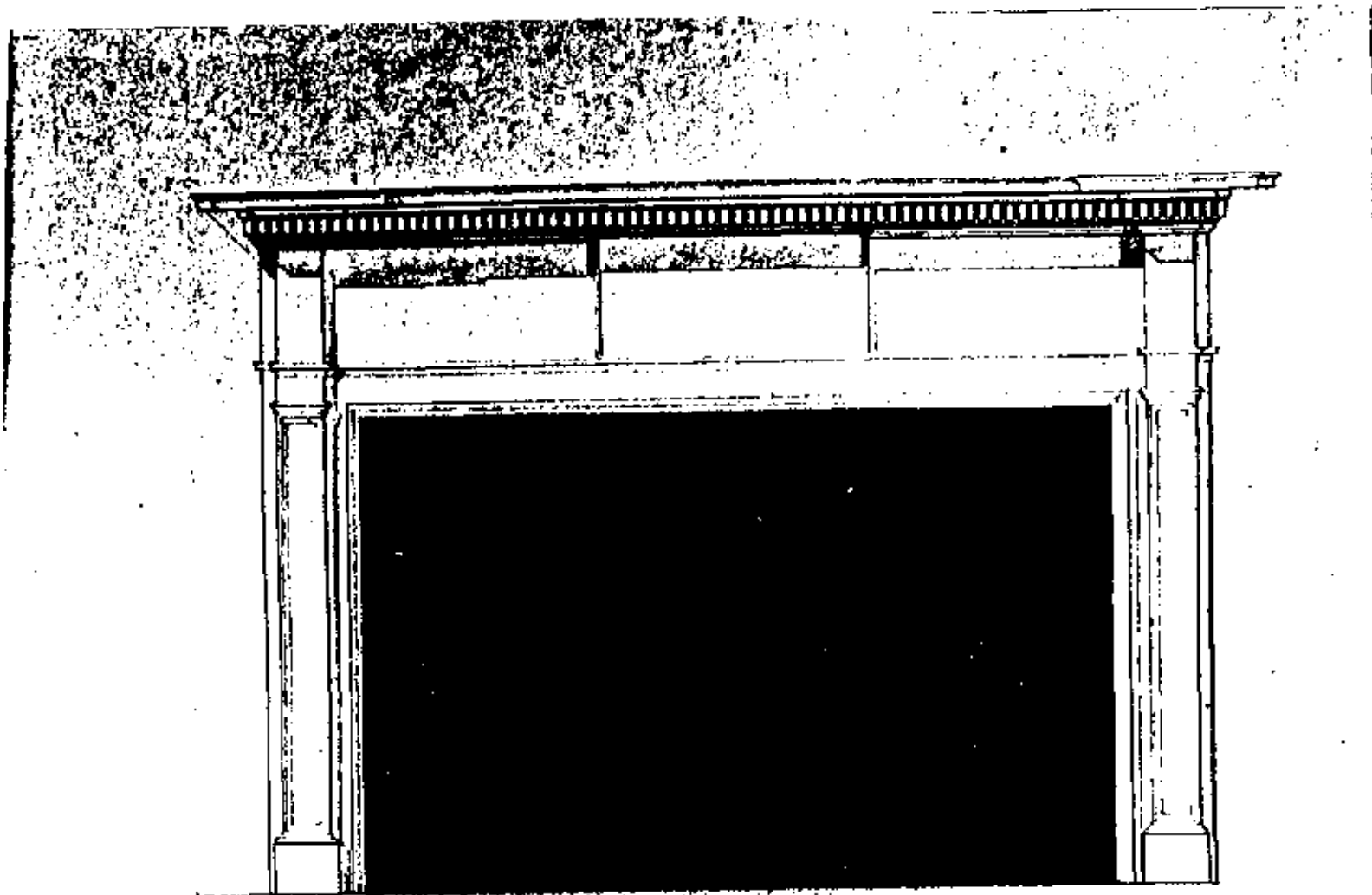

21

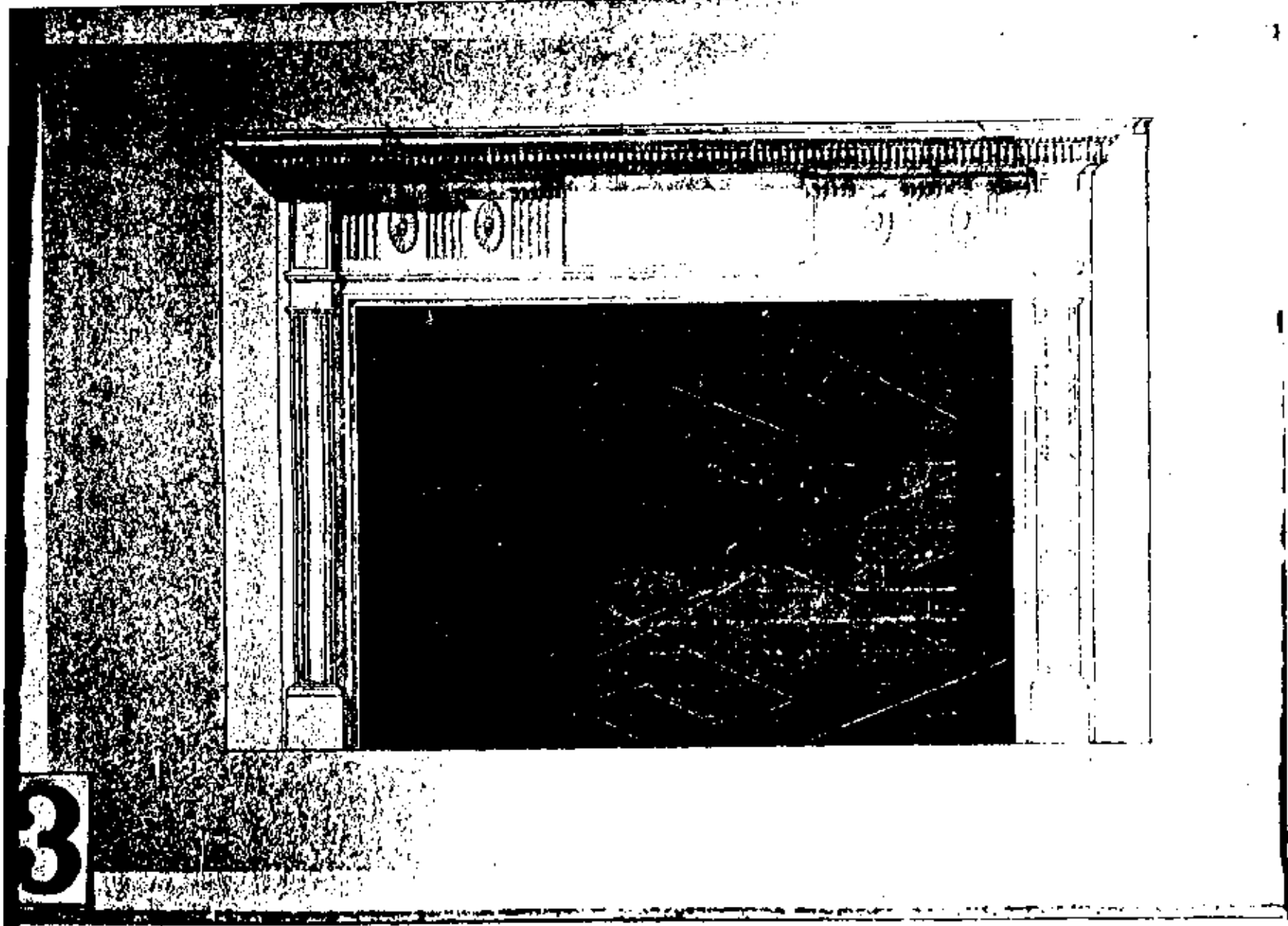

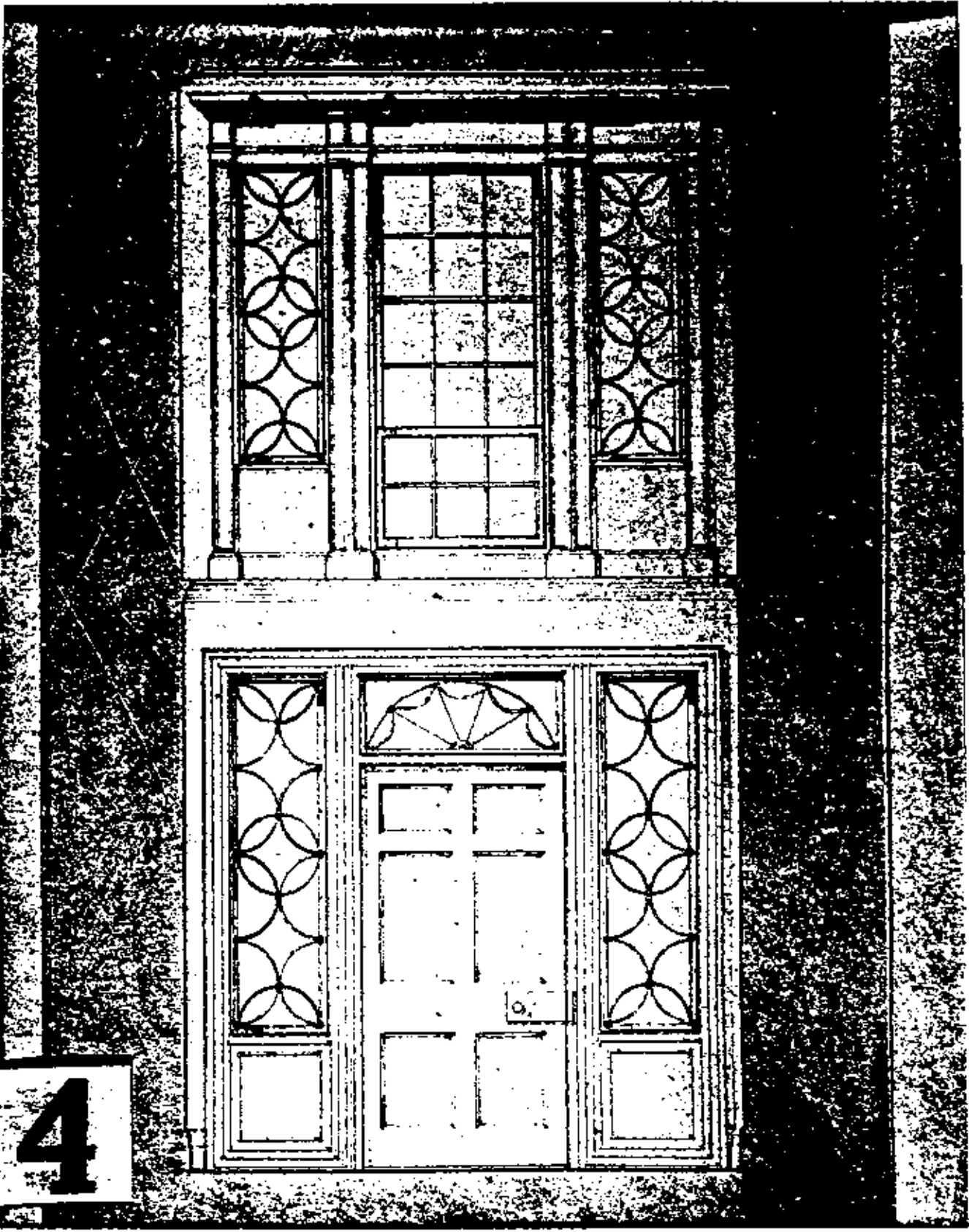

4

5

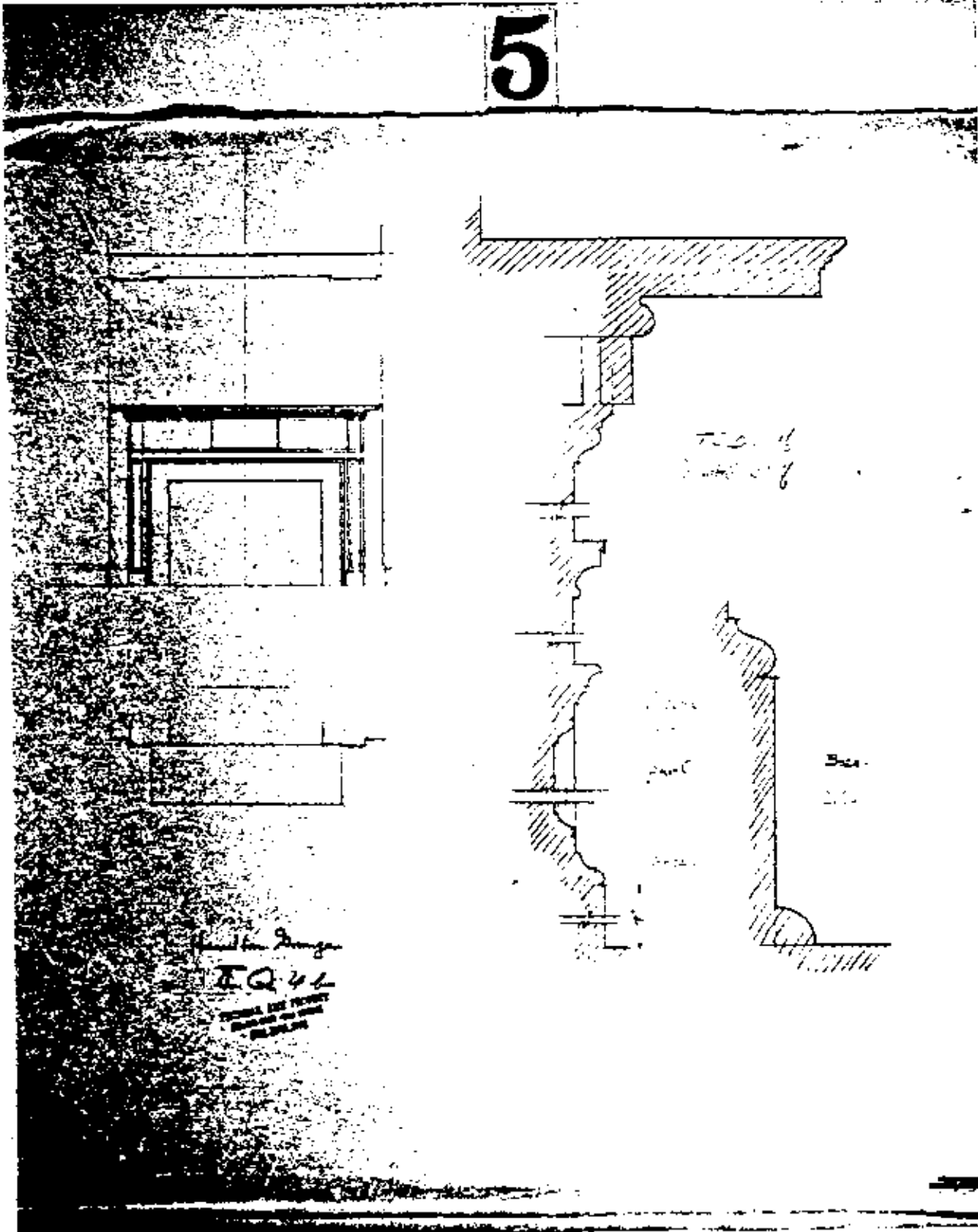

Franklin D. ...
EQ 42
FEDERAL BUREAU OF INVESTIGATION
WASHINGTON, D. C. 20535

FIG. 13
JAN 27 1968

B-4

PART C
PART D

6

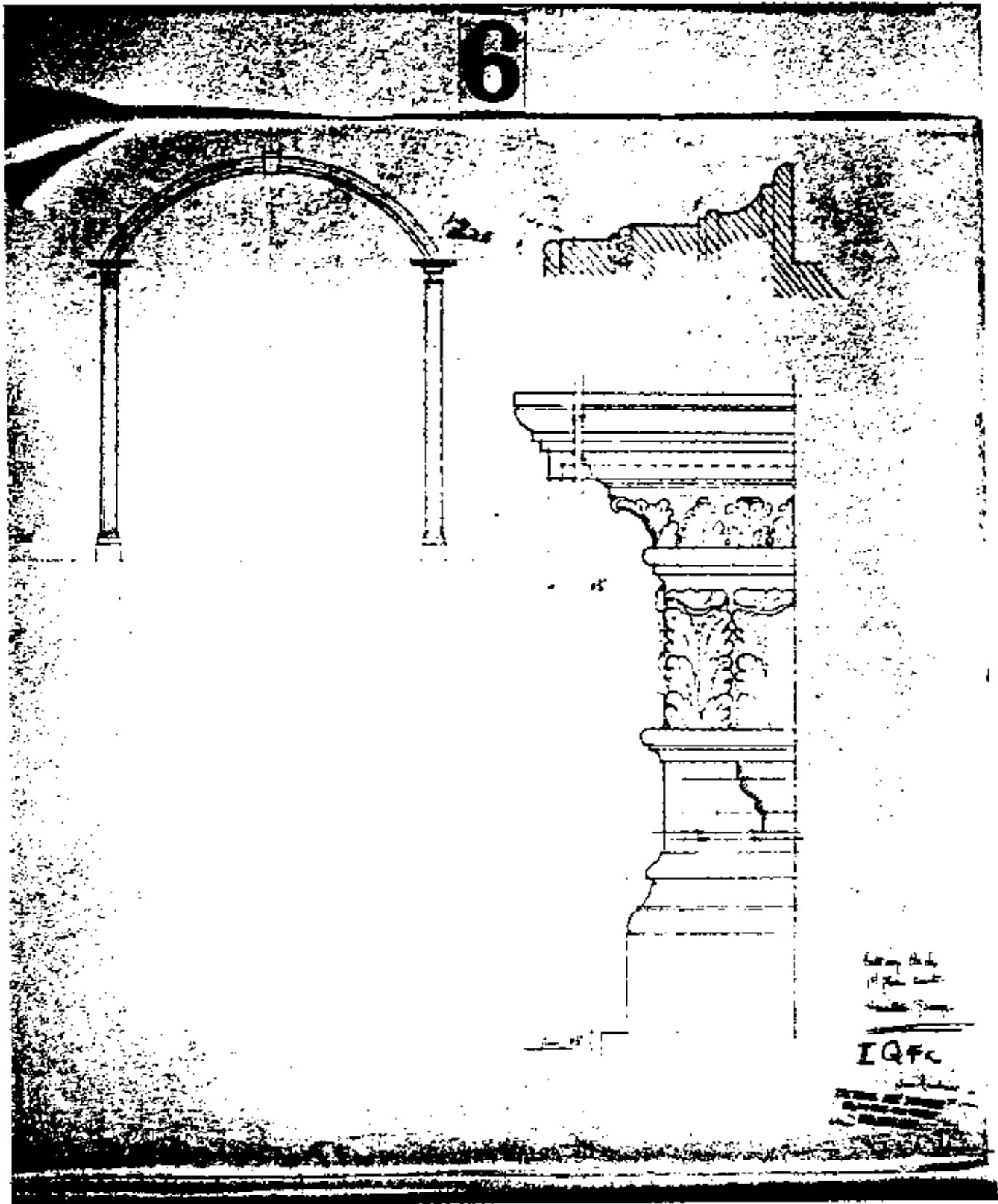

IQFC

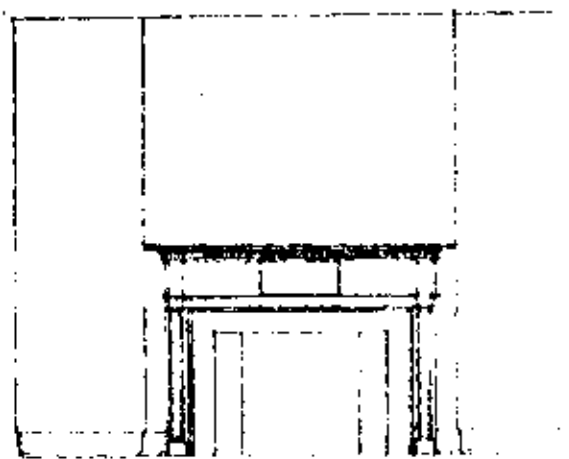

Mantel Elevation

Scale - 1/4" = 1'-0"



Door Elevation



Plan

Scale - 1/4" = 1'-0"

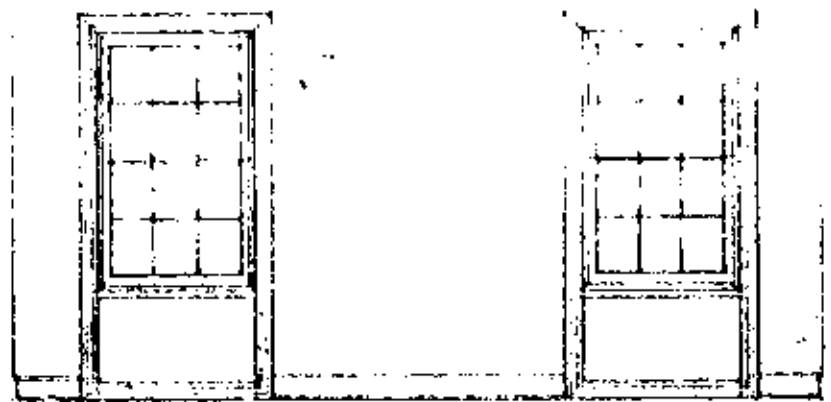

Window Elevation

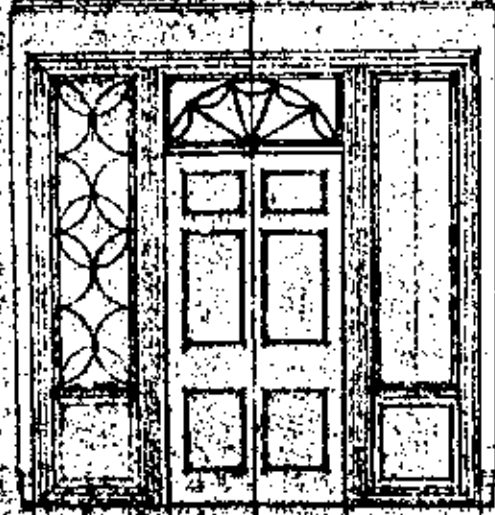
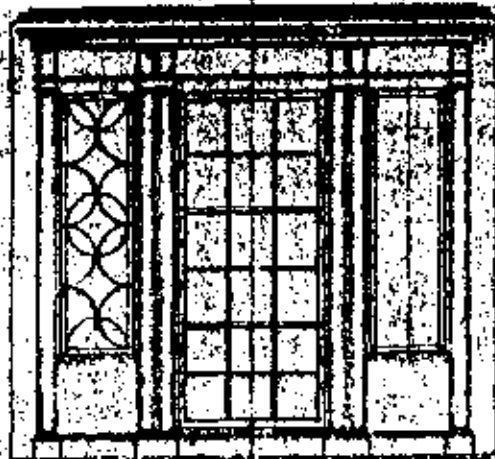

Window Detail



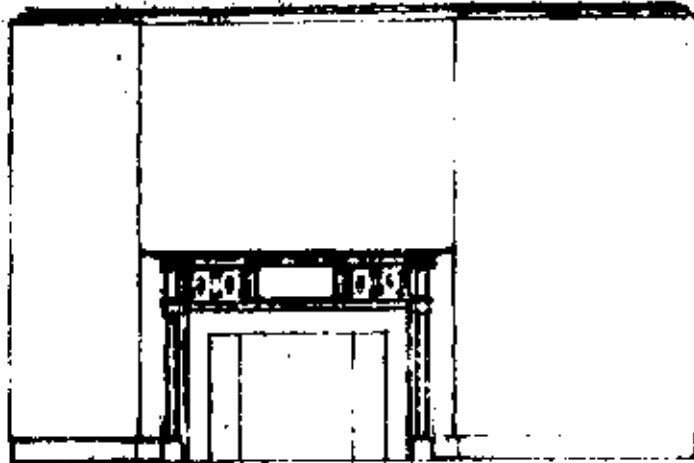

Mantel Elevation

Scale - 1/4" = 1'-0"

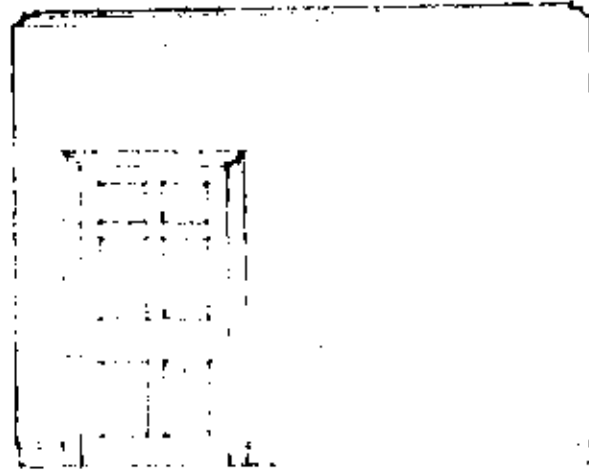

Door Elevation

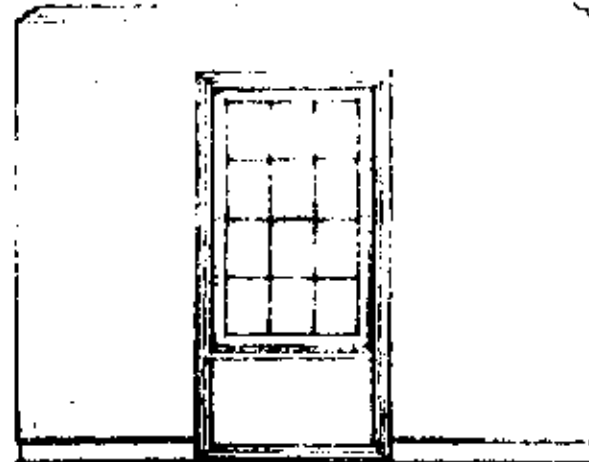

Window Elevation

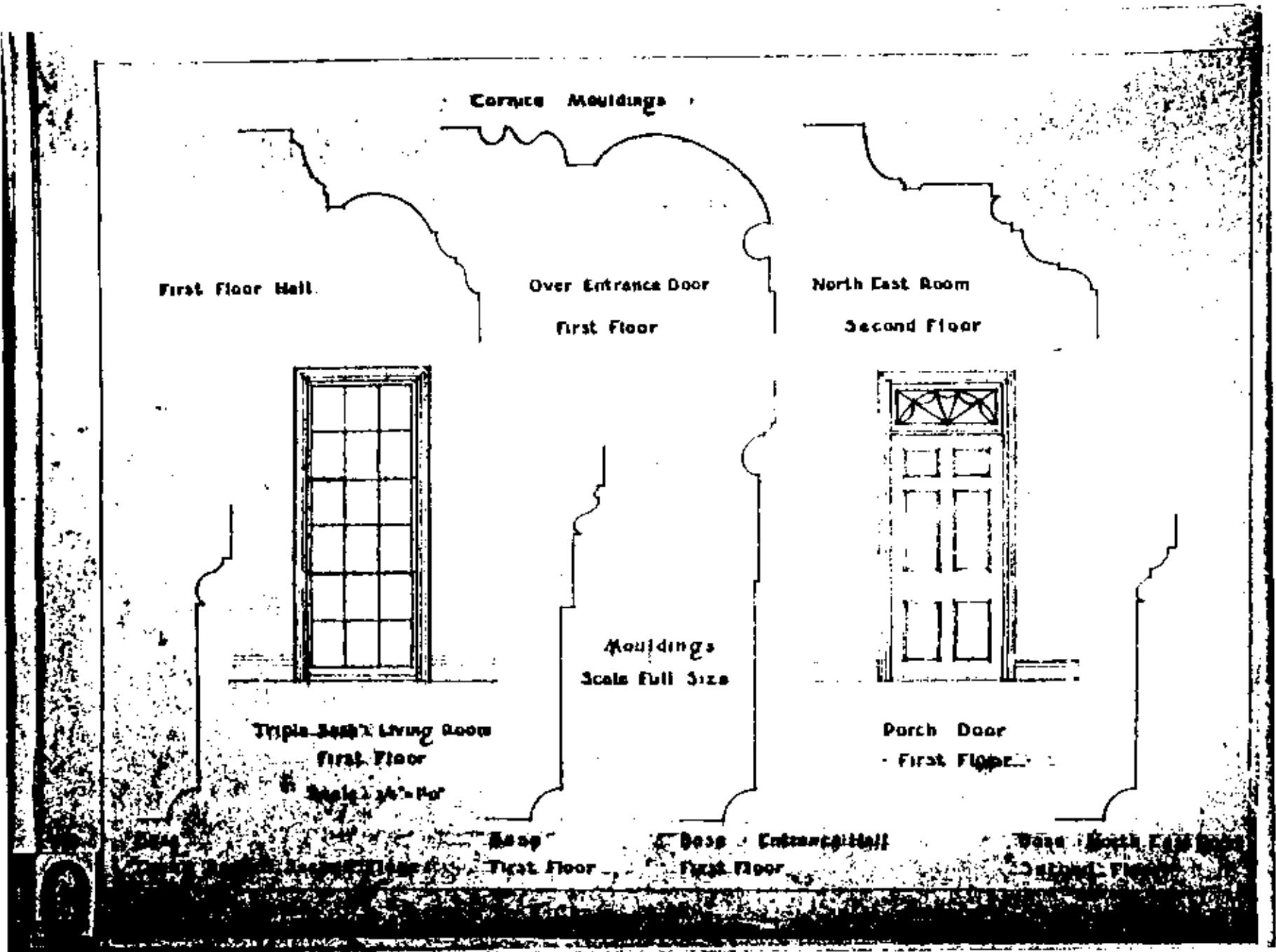

Cornice Mouldings

First Floor Hall

Over Entrance Door
First Floor

North East Room
Second Floor

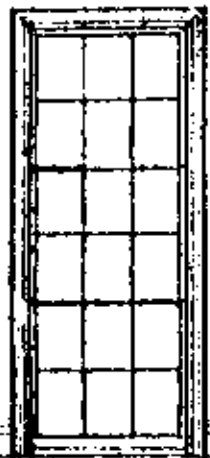

Triple Sash Living Room
First Floor
Scale 3/4" = 1'-0"

Mouldings
Scale Full Size

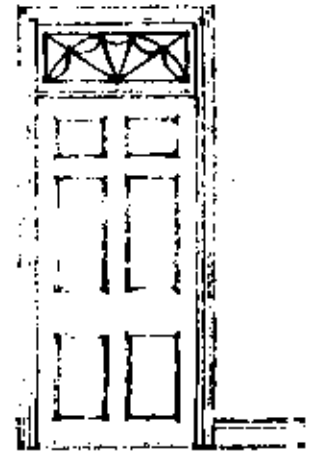

Porch Door
First Floor

Base
First Floor

Base Entrance Hall
First Floor

Base North East Room
Second Floor

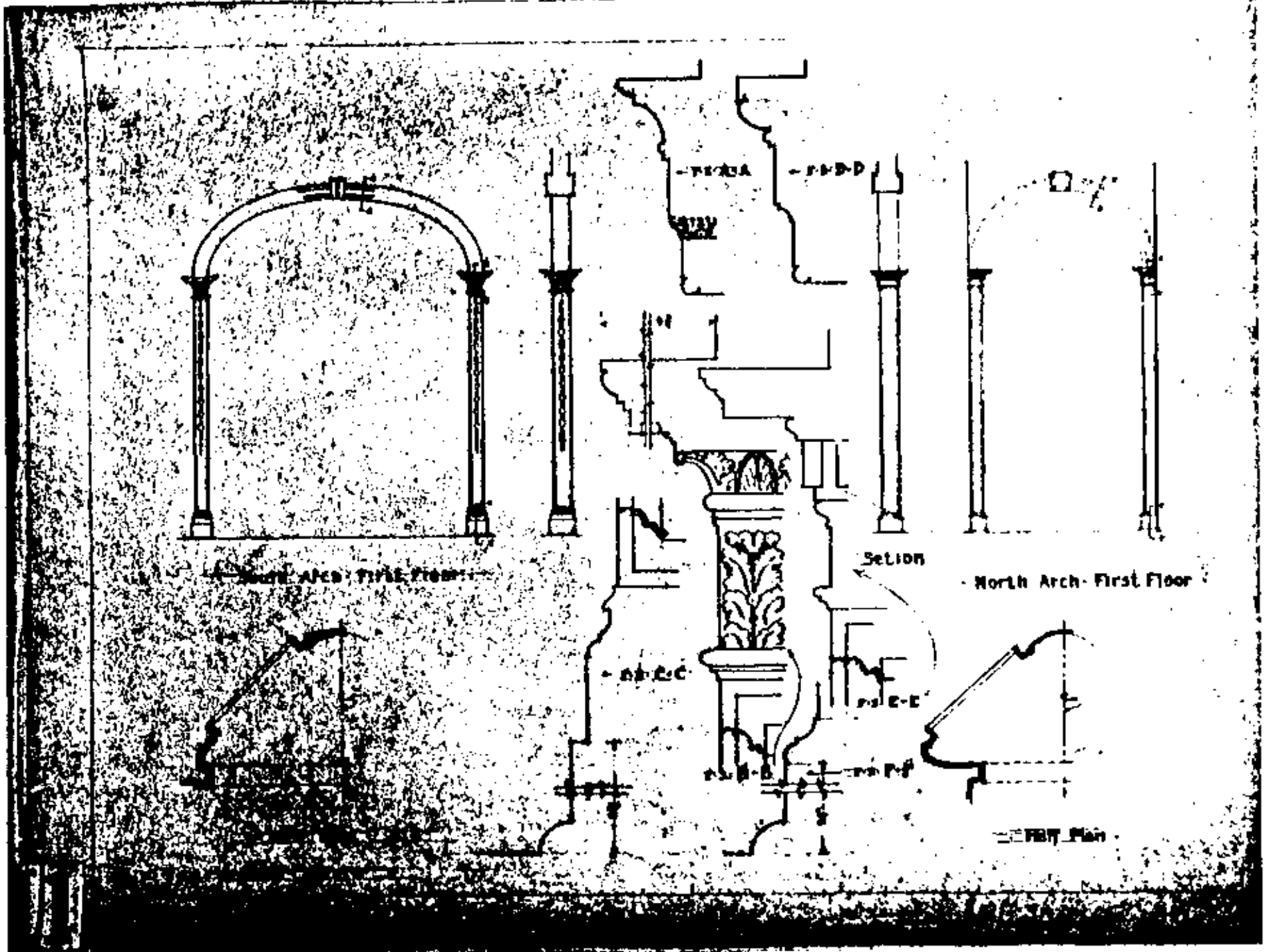

North Arch - First Floor

SECTION

North Arch - First Floor

Arch Plan

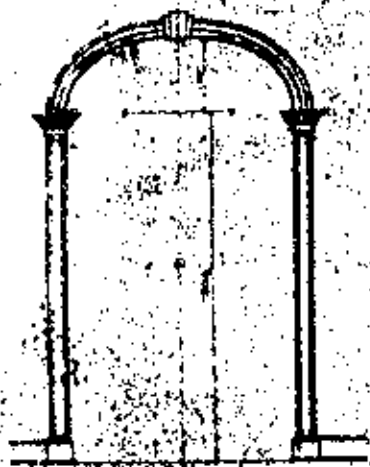

Arch - Second Floor
South Elevation

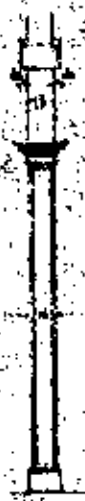

Section

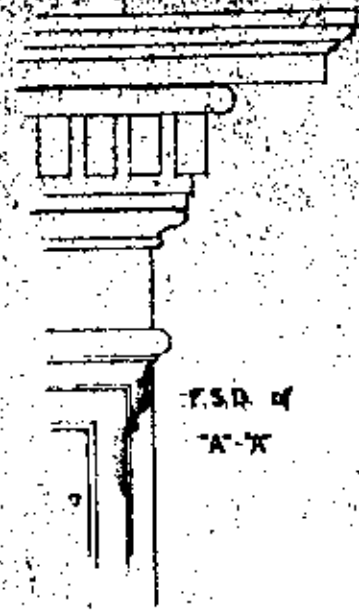

F.S.D. 2
"A-X"



South Arch



Typical Panel - Crown For All Panels

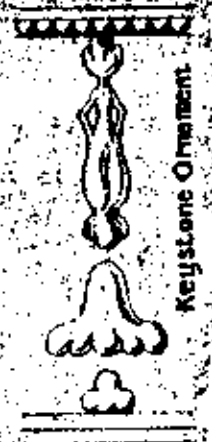

Keystone Ornament



Panel of Pilaster

Decorative Ornament

Appendix H

Hamilton Grange: Field Notebook
for the Index of American Design
1930's

Filed in the Avery Architectural Library,
Columbia University

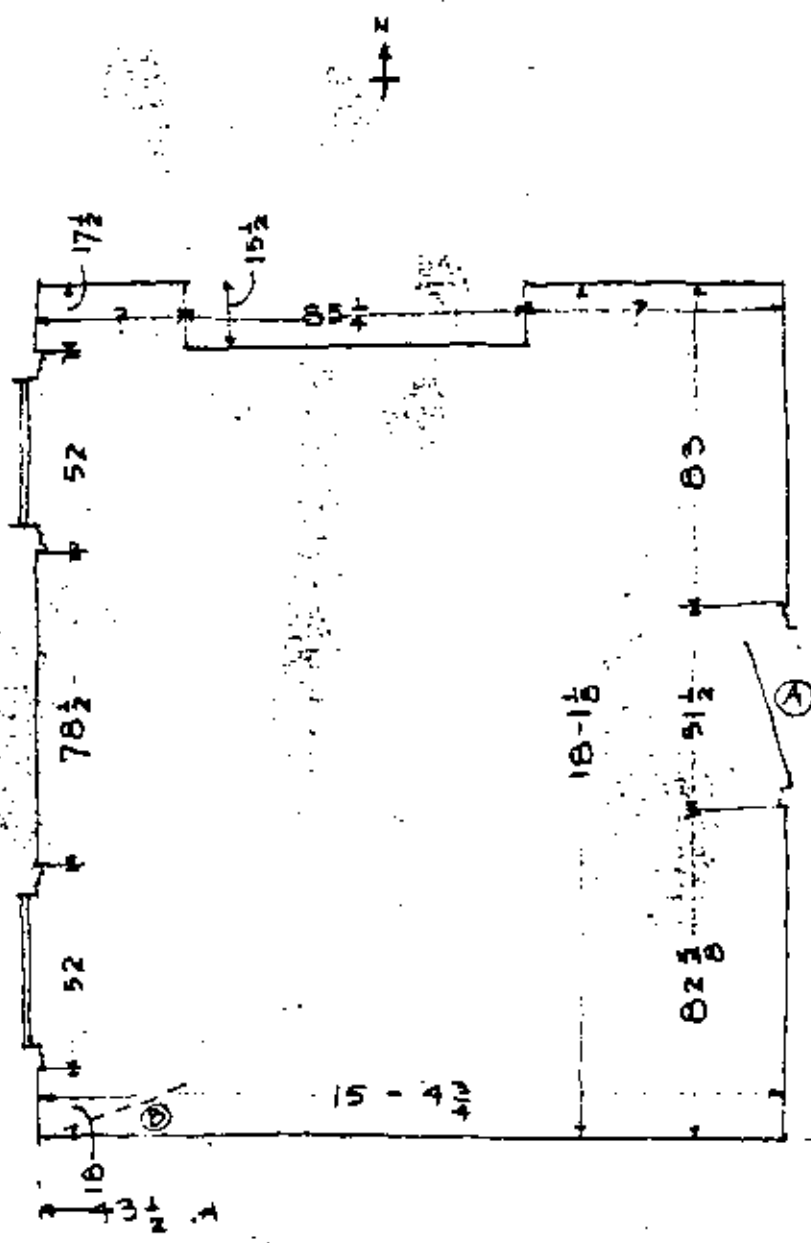

dig-bt. 10'-1"

LIVING RM. 2ND FL.

Note - Sash Typical for 2nd Fl.

(2)

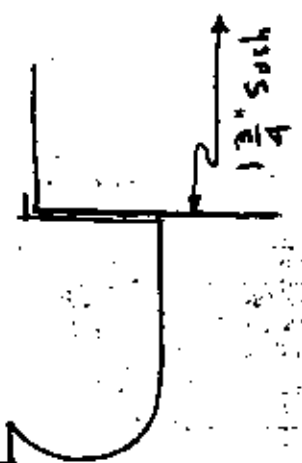
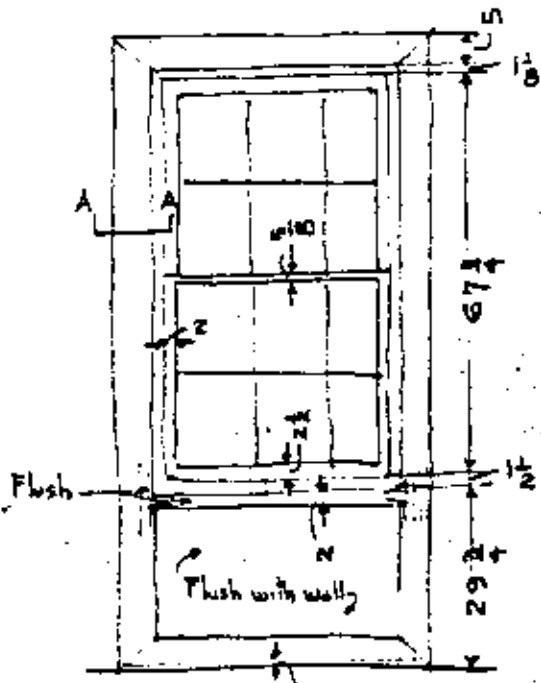

ALSO DOOR TRIM

F.S. SECTION A-A

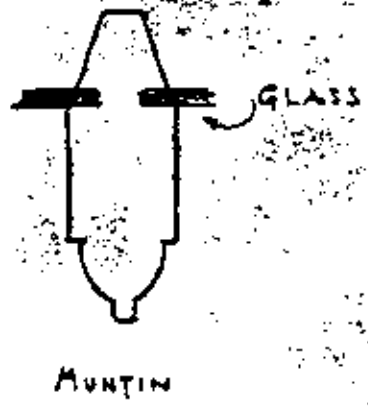

LIVING RM - 2ND FL.

See Window Trim ② for F.S.

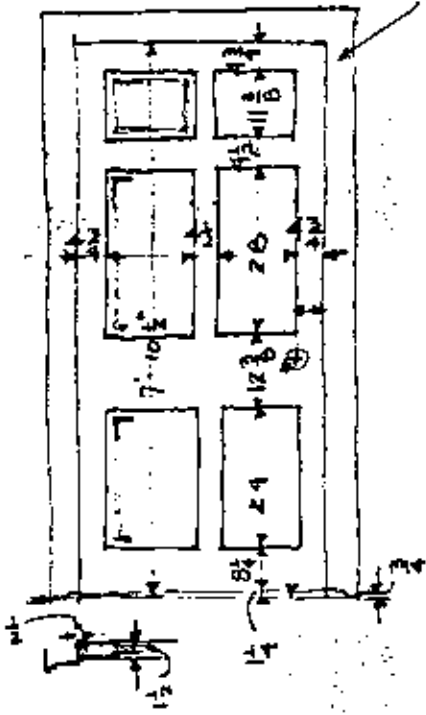

ENTRANCE DOOR ①

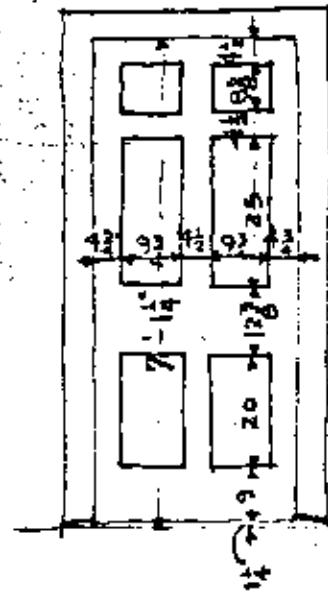

DOOR ② (Later addition)



F.S. DOOR PANEL MLDG

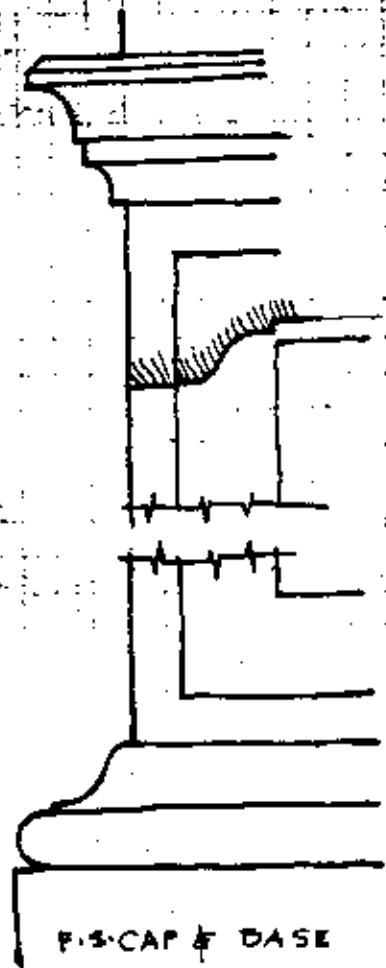
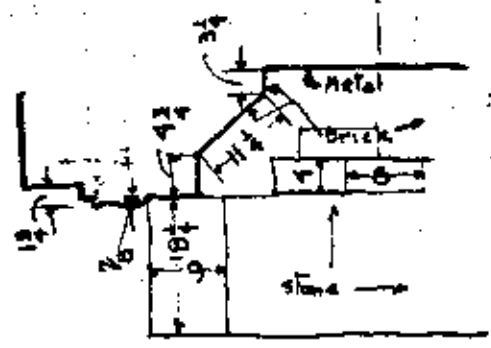
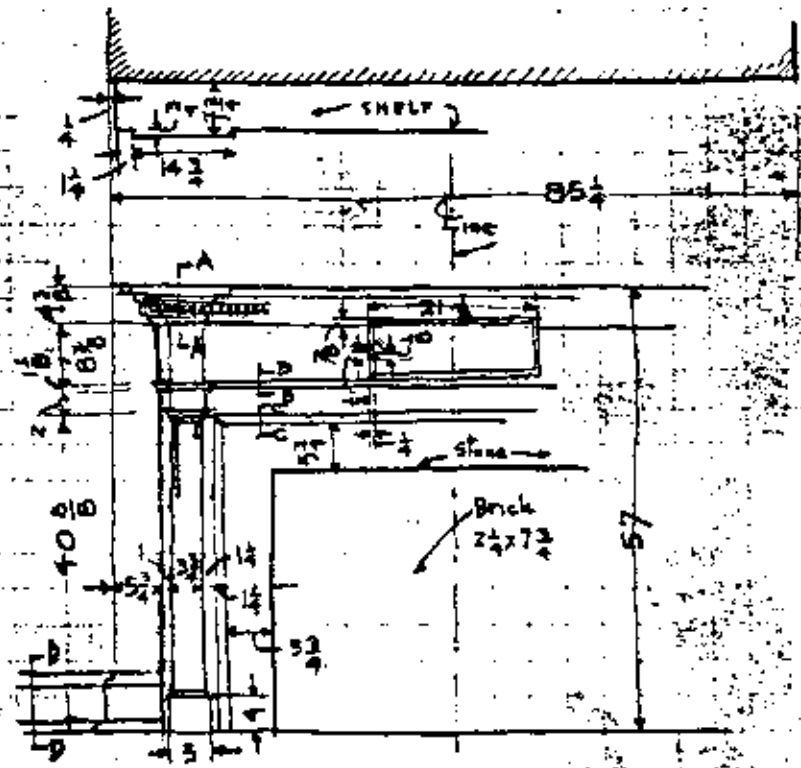

FIRE PLACE
LIVING R.M. - 2ND FL.

5

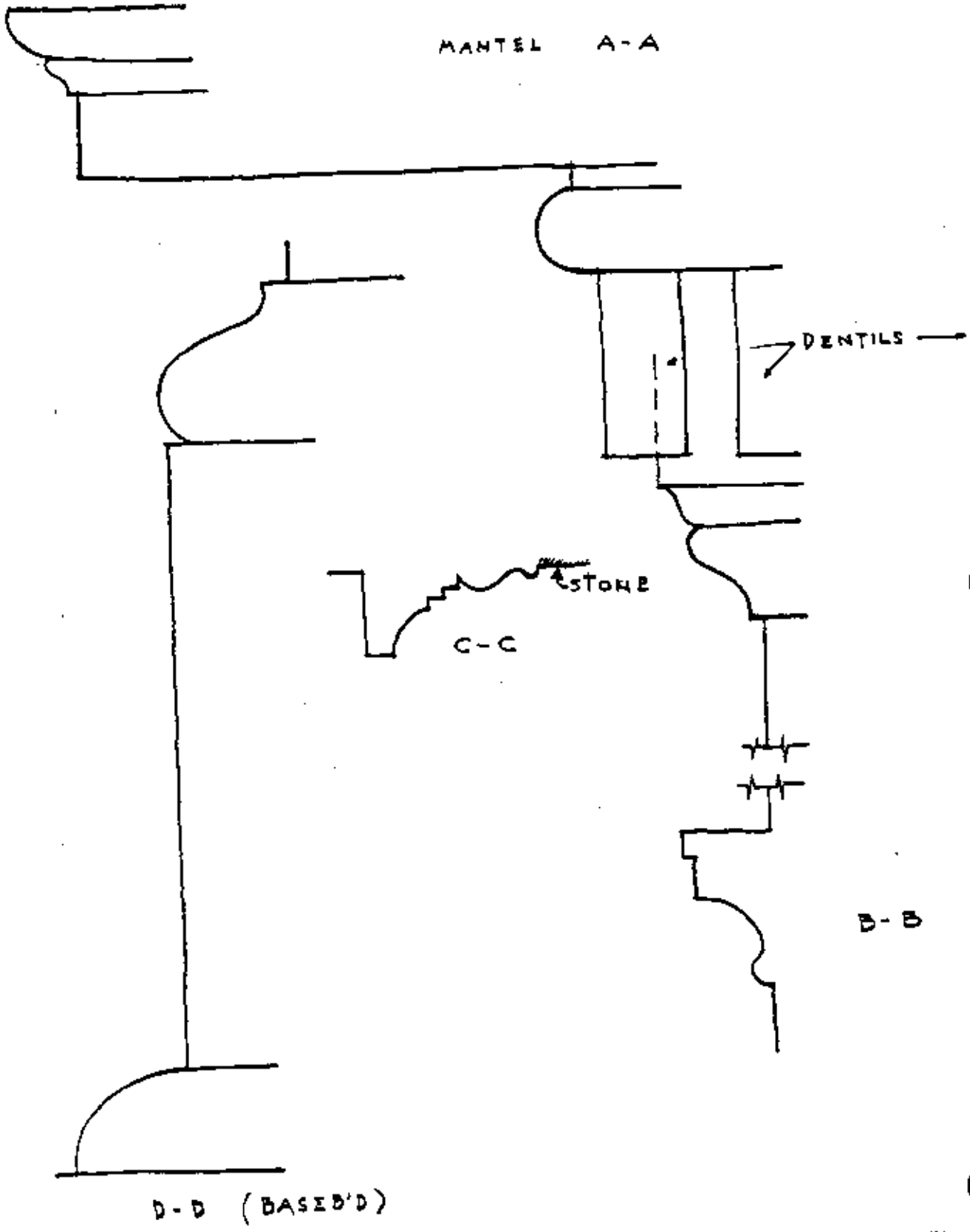

LIVING R'M - 2ND FL.

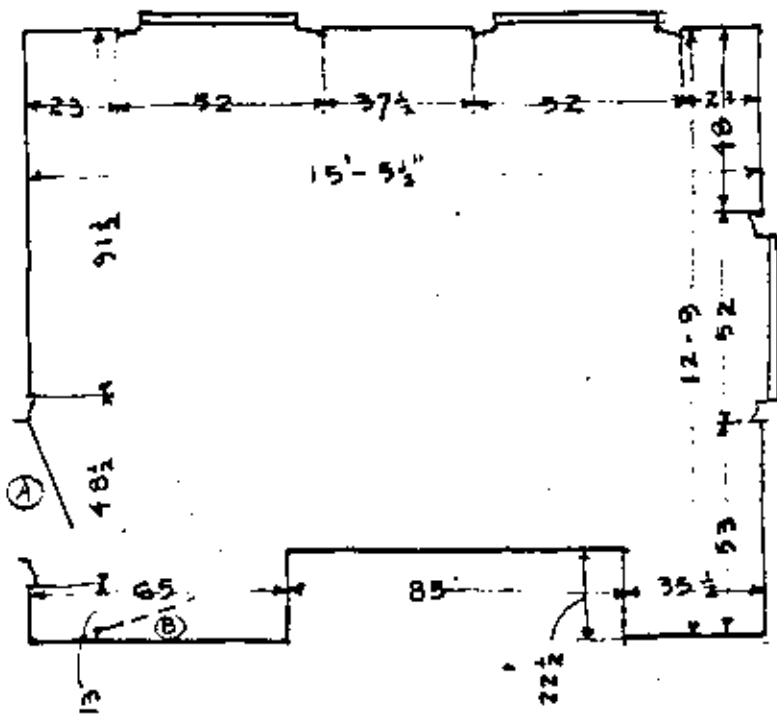

CLG-HT- 10'-13"

- NORTH EAST - R.M. - 2ND FL.

Note: Sash same as LIVING R'M, 2nd Fl. (See P. 2)

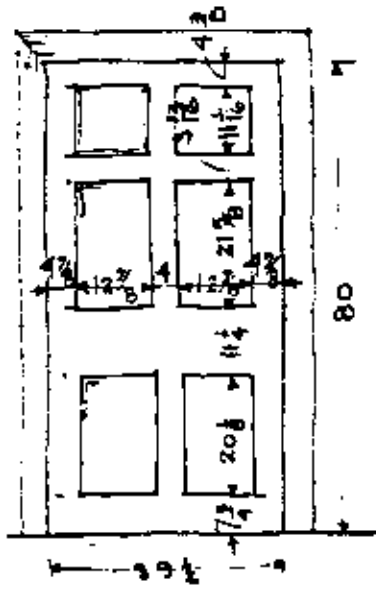

DOOR A

(DOOR B Later addition) not measured

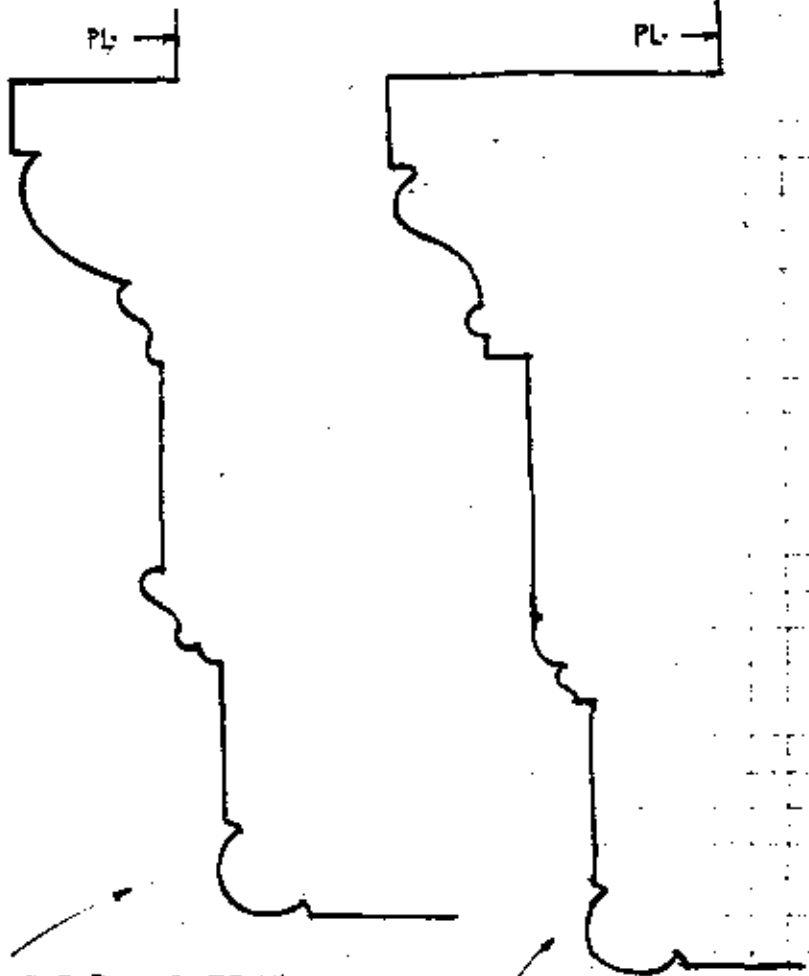

F.S. DOOR TRIM

F.S. WINDOW TRIM

INTERIOR FACE



EXTERIOR FACE



F.S. SECTION OF DOOR

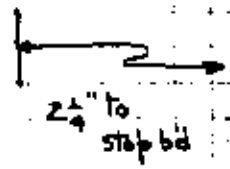

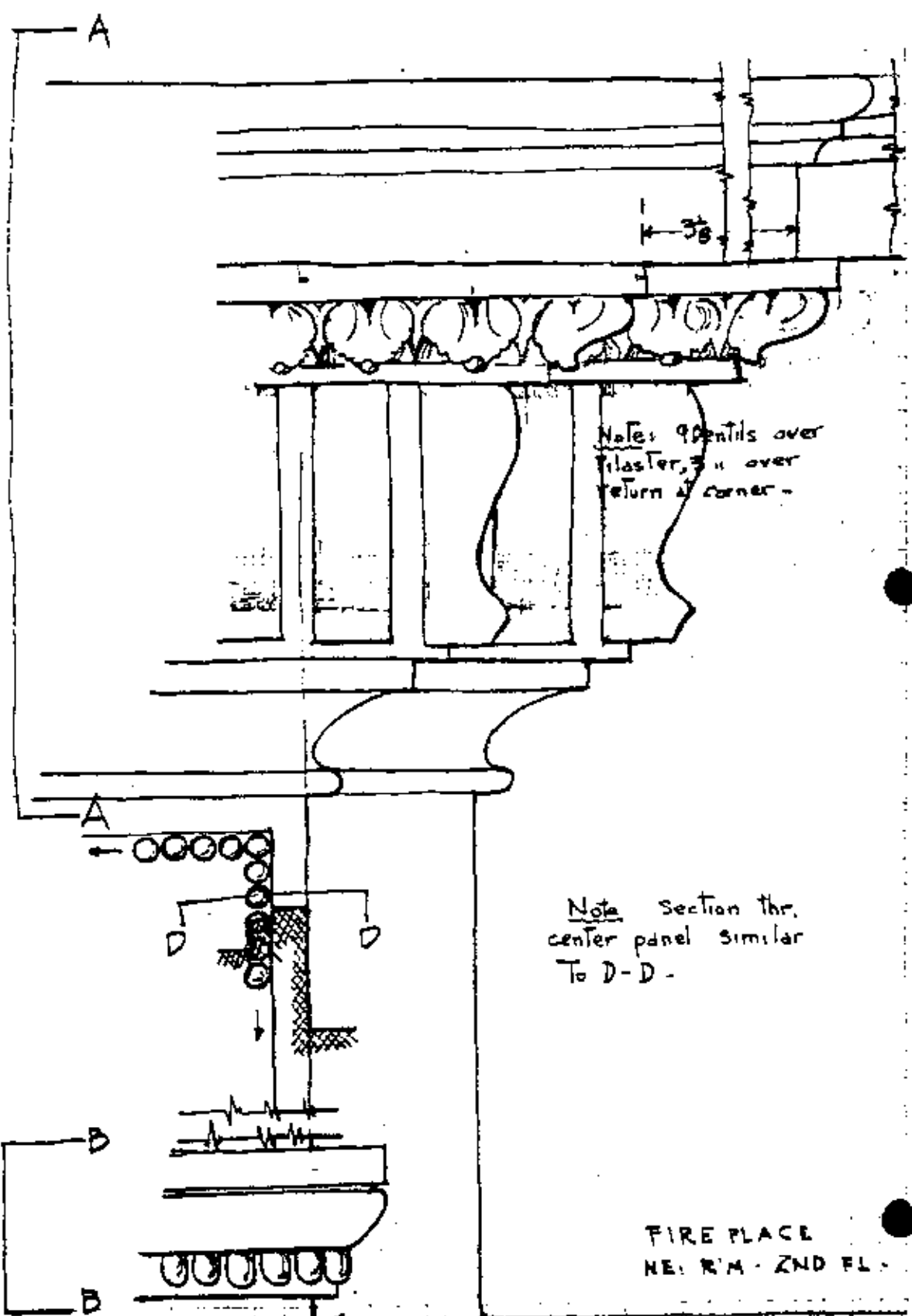

Note section thr.
 center panel similar
 To D-D -

FIRE PLACE
 NE. R.M. - 2ND FL.

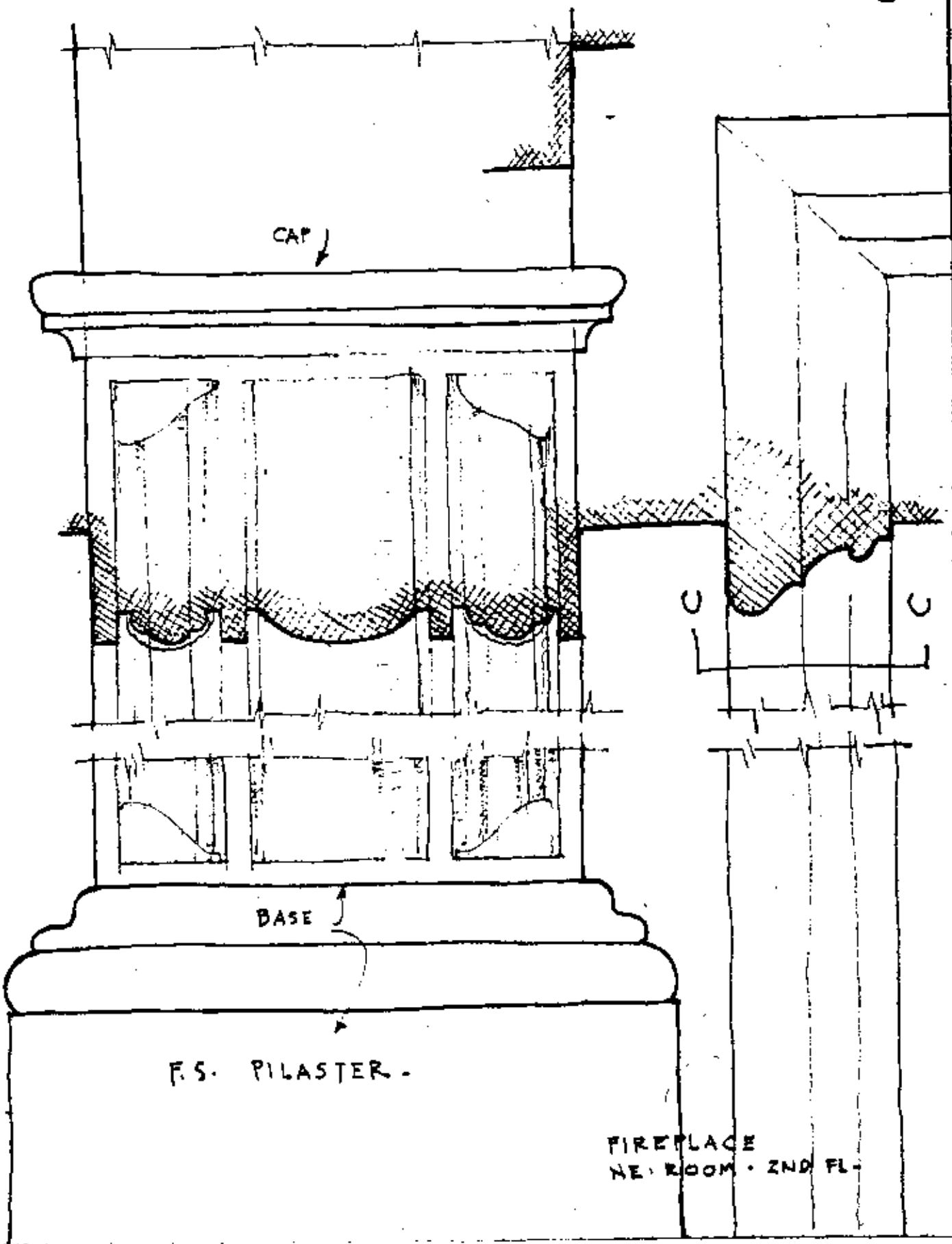

CAP

BASE

F.S. PILASTER.

FIREPLACE
HE. ROOM - 2ND FL.

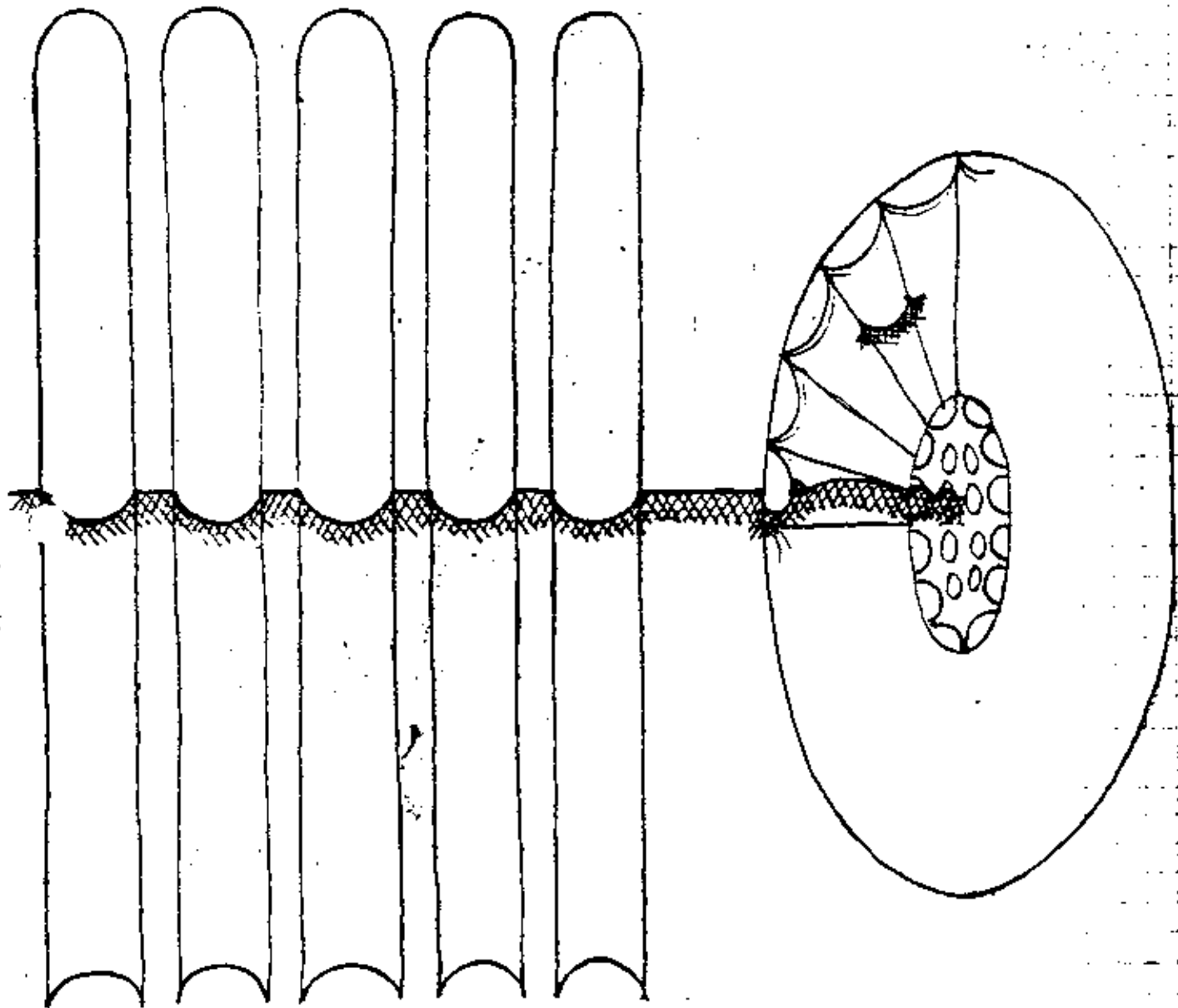

F.S. PANEL CARVING

- FIREPLACE -
- NE. ROOM - 2ND. FL. -

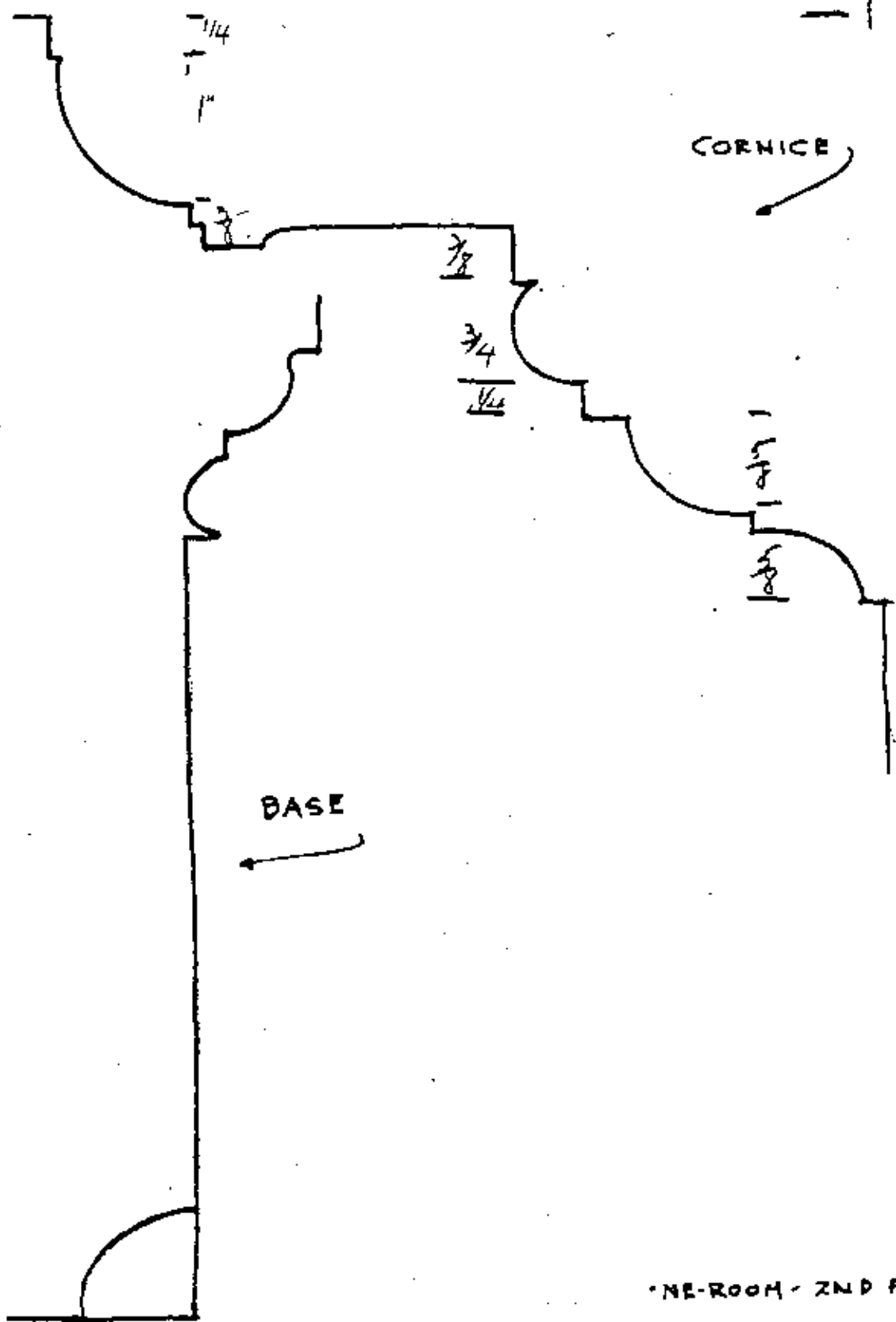

NE-ROOM - 2ND FL.

10 - Dentils - 1/4

P.S. MUNTIN -

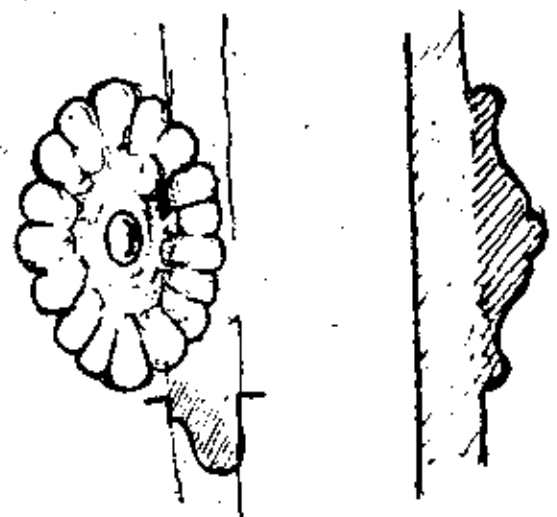
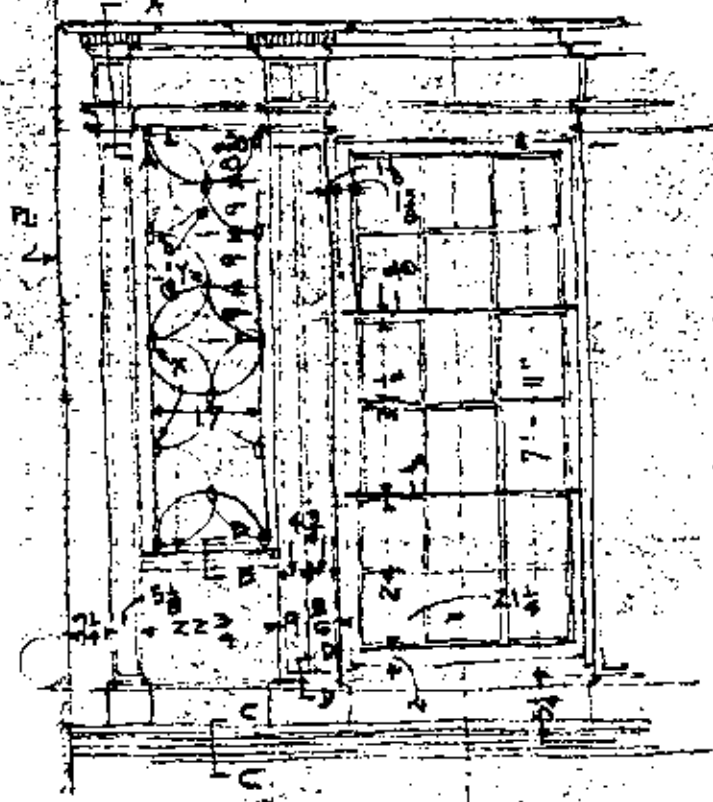

P.S. LEAD BUTTON - X -

Note: Buttons on Leaded Sash at front Ent. similar - (See page 10)

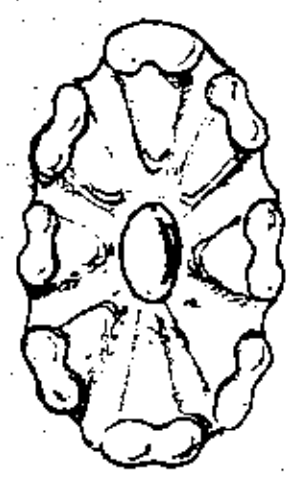

P.S. LEAD BUTTON - Y -

- STAIR HALL WINDOW -

"SOUTH WALL"

PLAN OF CORNICE
BREAK OVER
END PILASTER

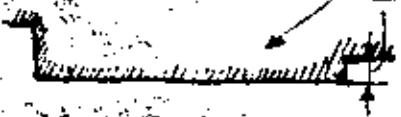

DENTILS

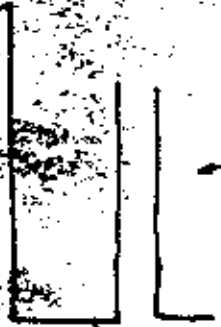

PANEL

P.S. -
FILASTER -
PANEL - MLDG.

DOUBLE FILASTER - 5 1/2" - 0



FILASTER CAP

P.S. SECTION A-A

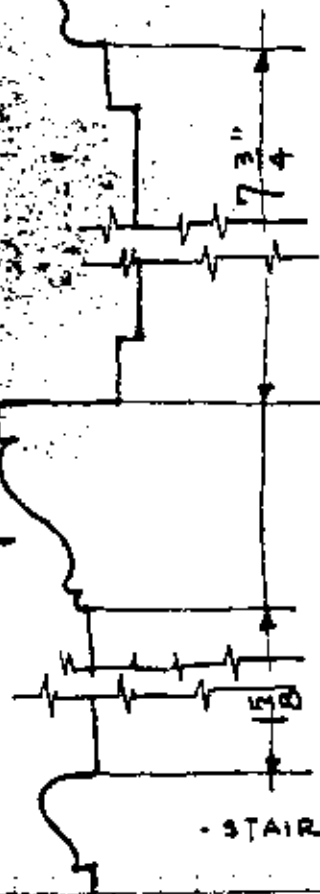

STAIR HALL WINDOW

15

LEAD SASH

$7\frac{1}{2}$

FLUSH WITH
PANEL MLD

F.S. D-D

F.S. D-D

F.S. C-C

PL.

- STAIR HALL WINDOW -

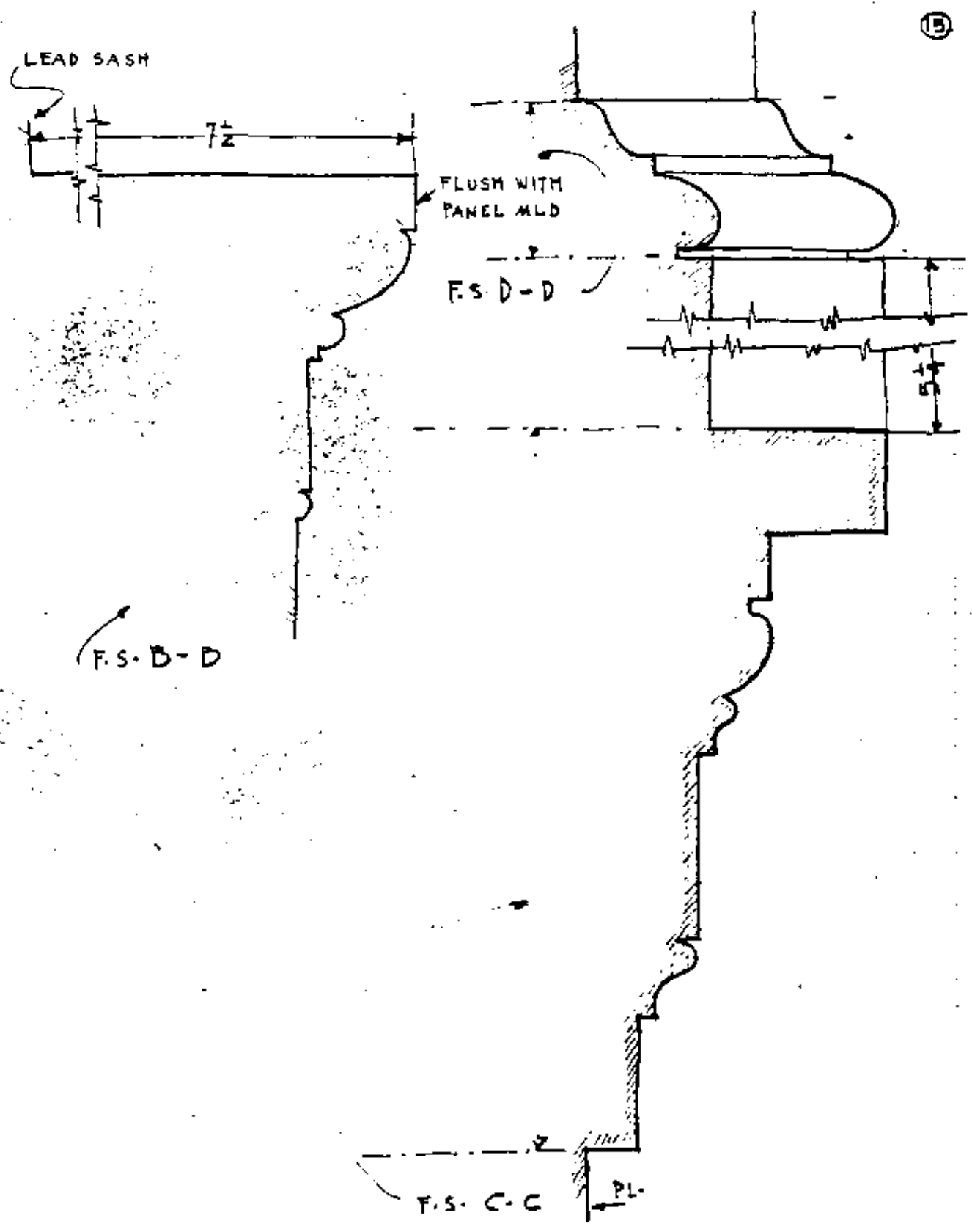

see page 23 for
F.S. Section A-A
B-B
C-C

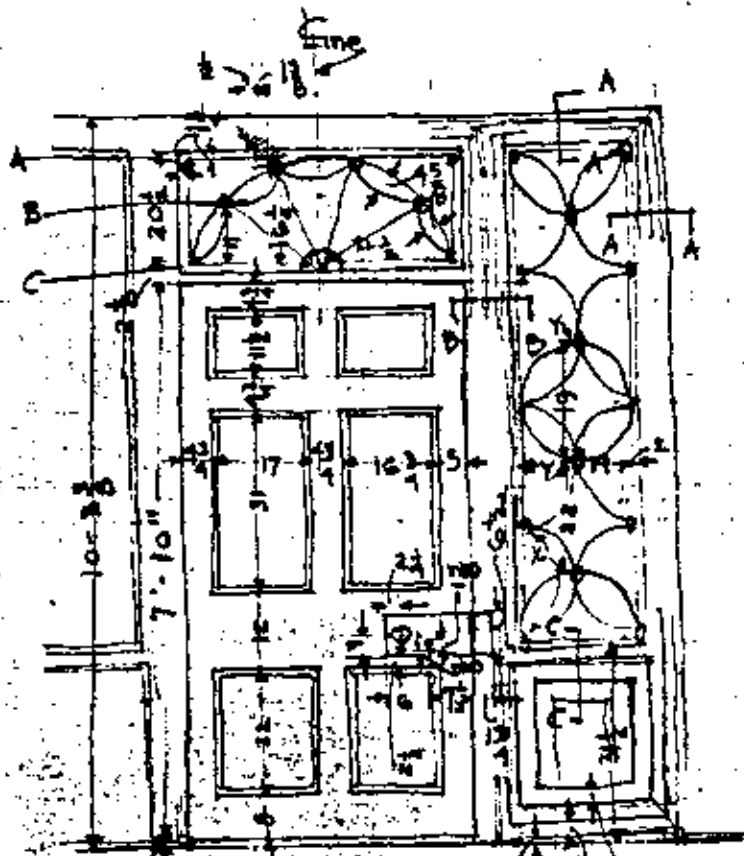

Notes: For P.S. Lead Buttons
X & Y see page 13.

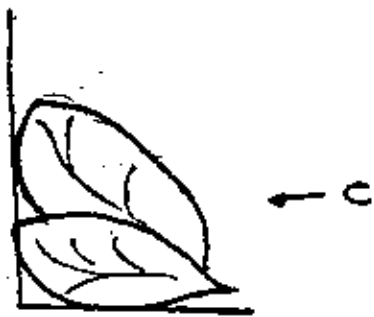
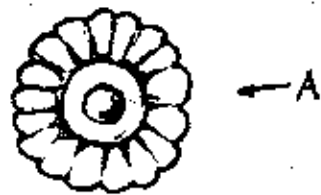

Note: Entrance was originally
under Stair Hall Window - now
on West Elevation - Door knob
2" diam. Lock, 1 1/2" proj. fr. door

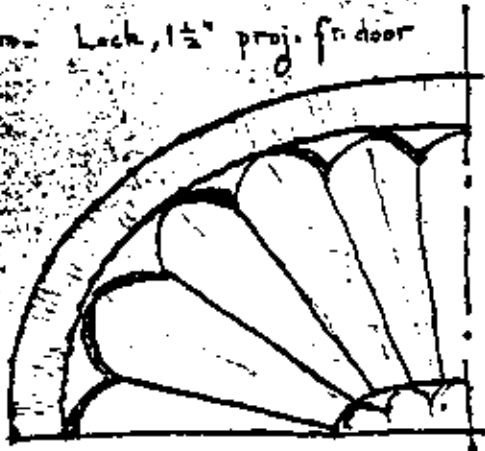

center lead ornament -

MAIN ENTRANCE -

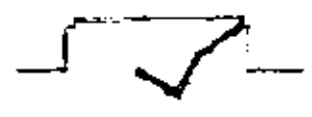
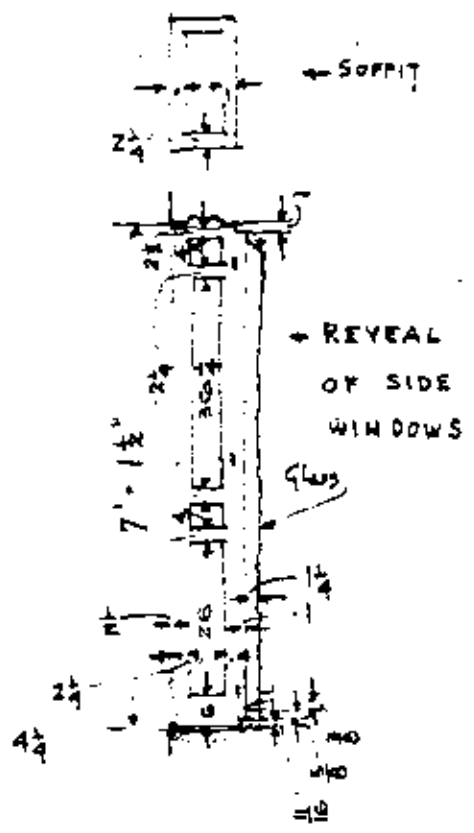

PLAN OF SHUTTER -
 Notes: Reverse side has
 flush panels, vertical bead -
 Fixed panels on reveal
 nearer door.

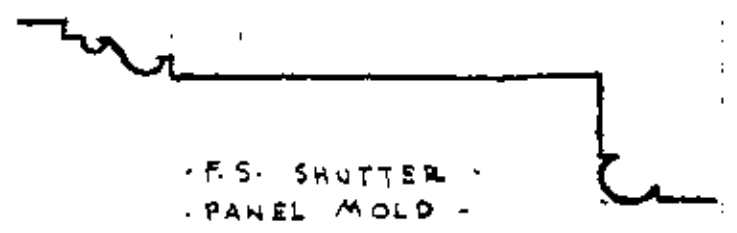
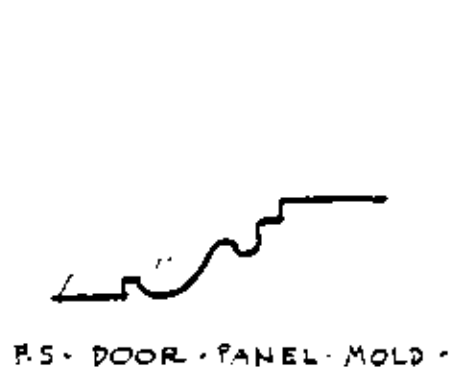
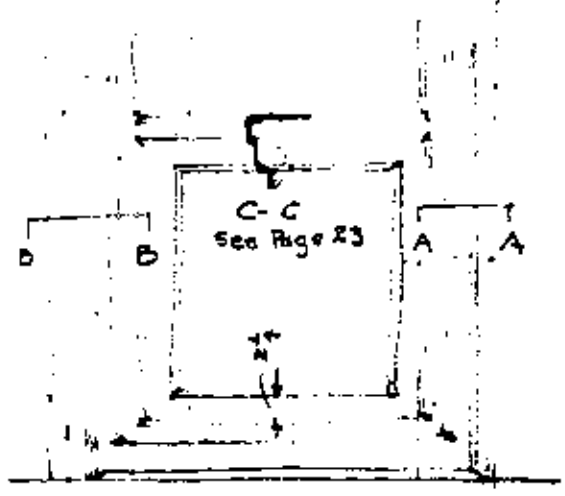

MAIN ENTRANCE

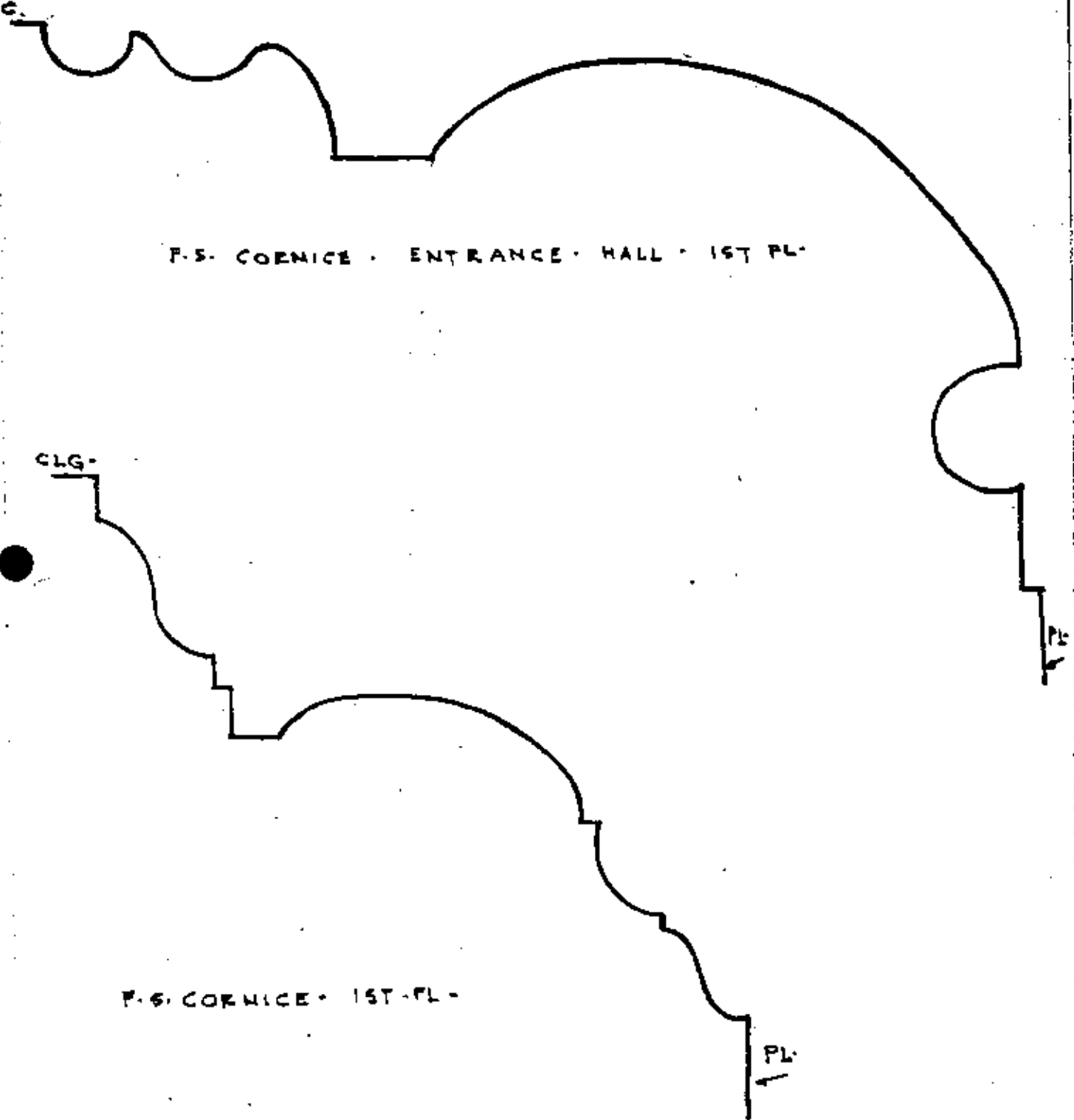

P.S. CORNICE · ENTRANCE · HALL · 1ST FL.

CLG.

P.S. CORNICE · 1ST FL.

PL.

PL.

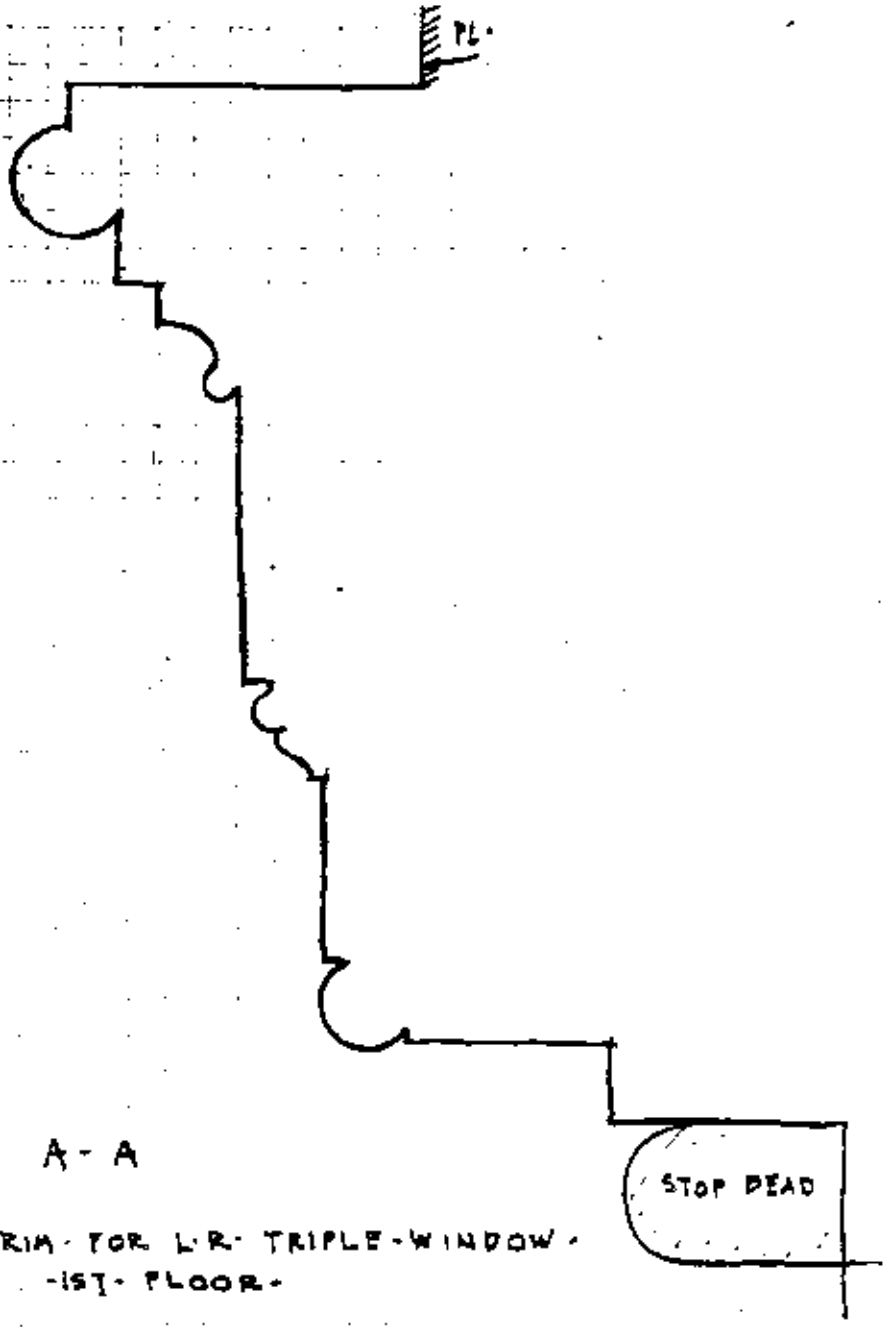

A - A

FS TRIM FOR L.R. TRIPLE WINDOW
- 1ST FLOOR -

- see page 21 -

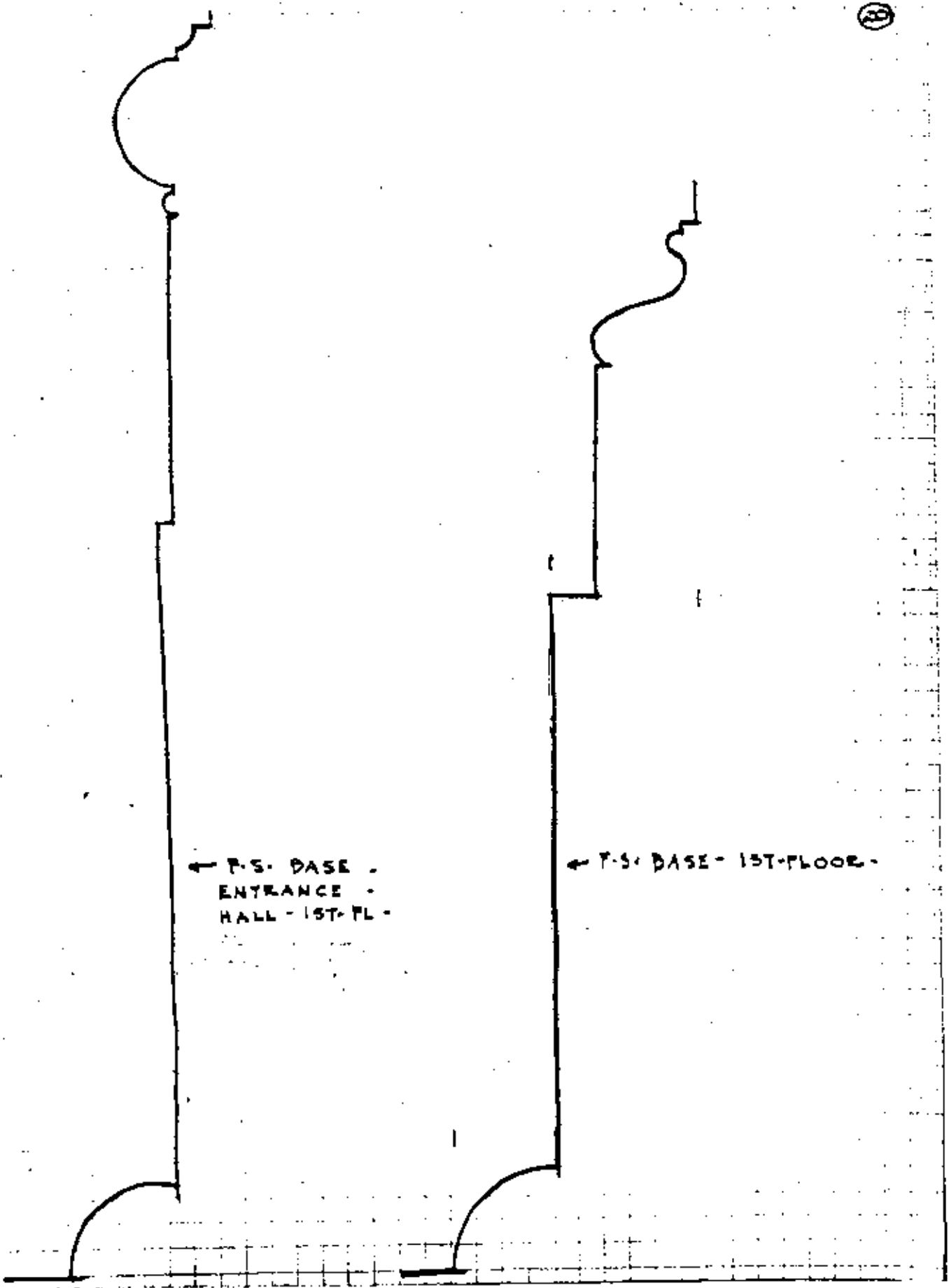

← P.S. BASE -
ENTRANCE -
HALL - 1ST FL -

← P.S. BASE - 1ST FLOOR -

Note: Trim similar to
2nd Fl. L.R. See Page 2.

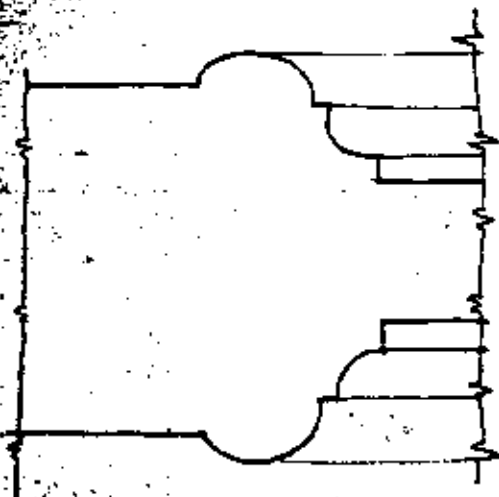
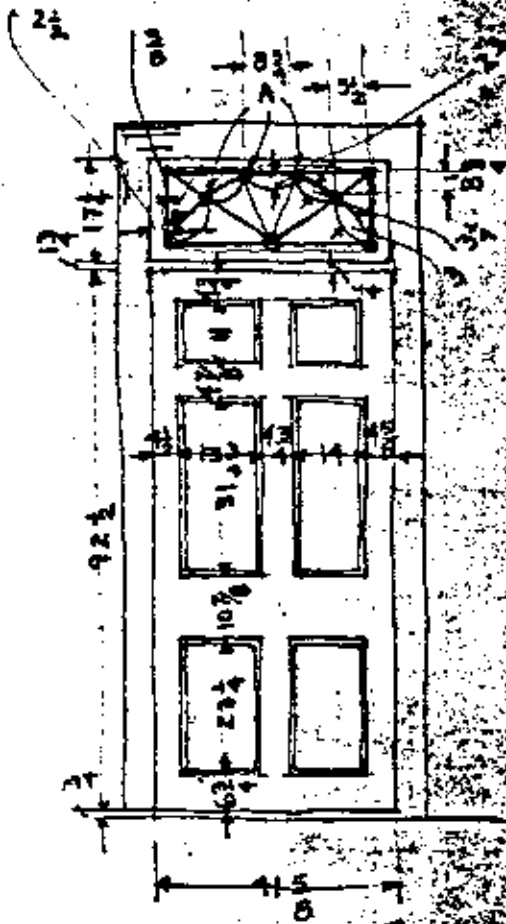

F.S. DOOR PANEL SECTION -

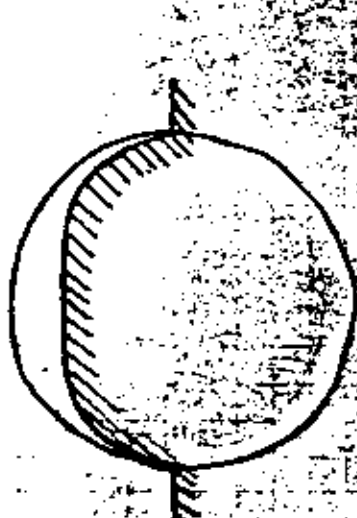

F.S. LEAD BUTTON - A -

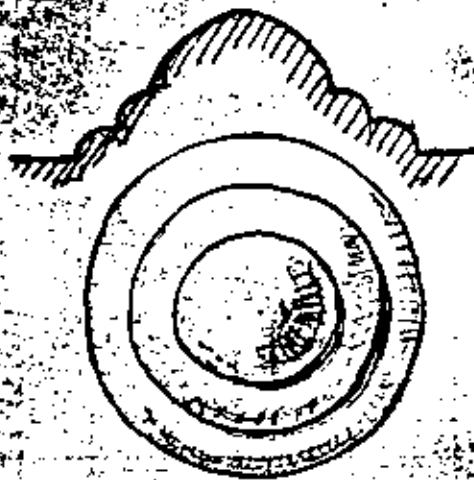

F.S. CENTER BUTTON

DOOR - NW ROOM
1ST FL -

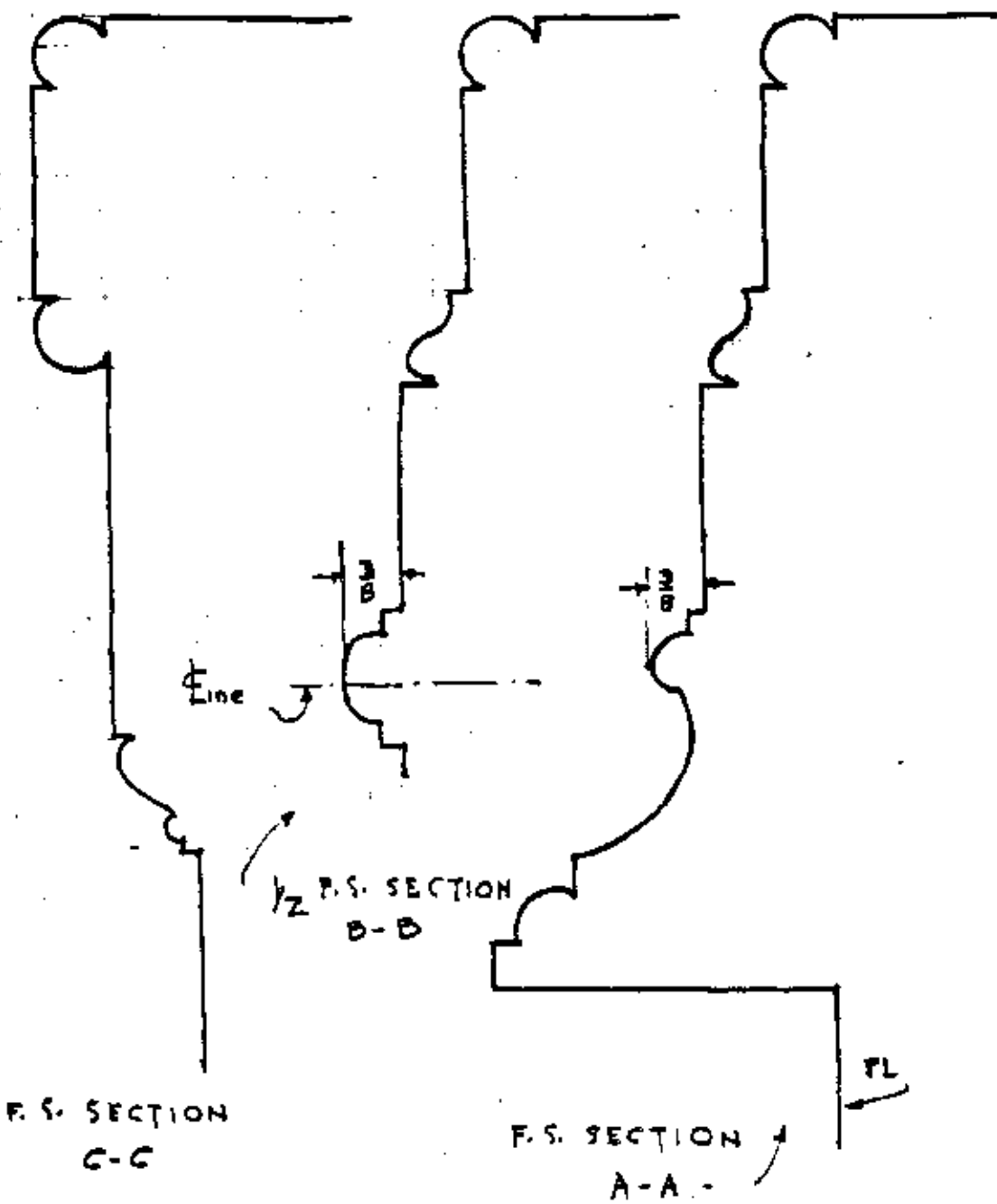

F.S. SECTION
C-C

F.S. SECTION
A-A

1/2 P.S. SECTION
B-B

F.L.

Note: See Page 16.
-MAIN ENTRANCE-

Note: Trim similar to L.R. 2nd Fl. See page 2

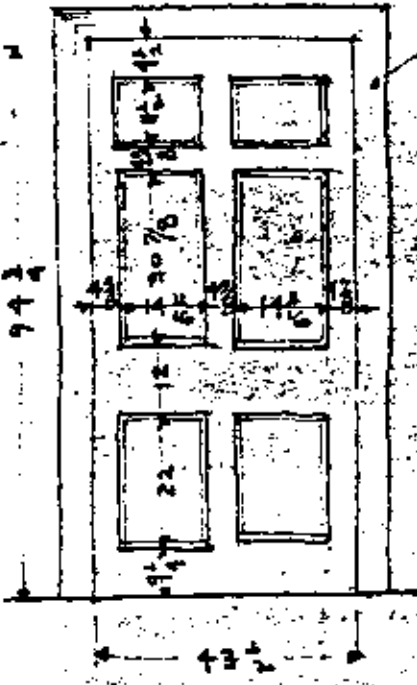

P.S. PANEL MOLD

TYPICAL DOOR - 1ST FL.

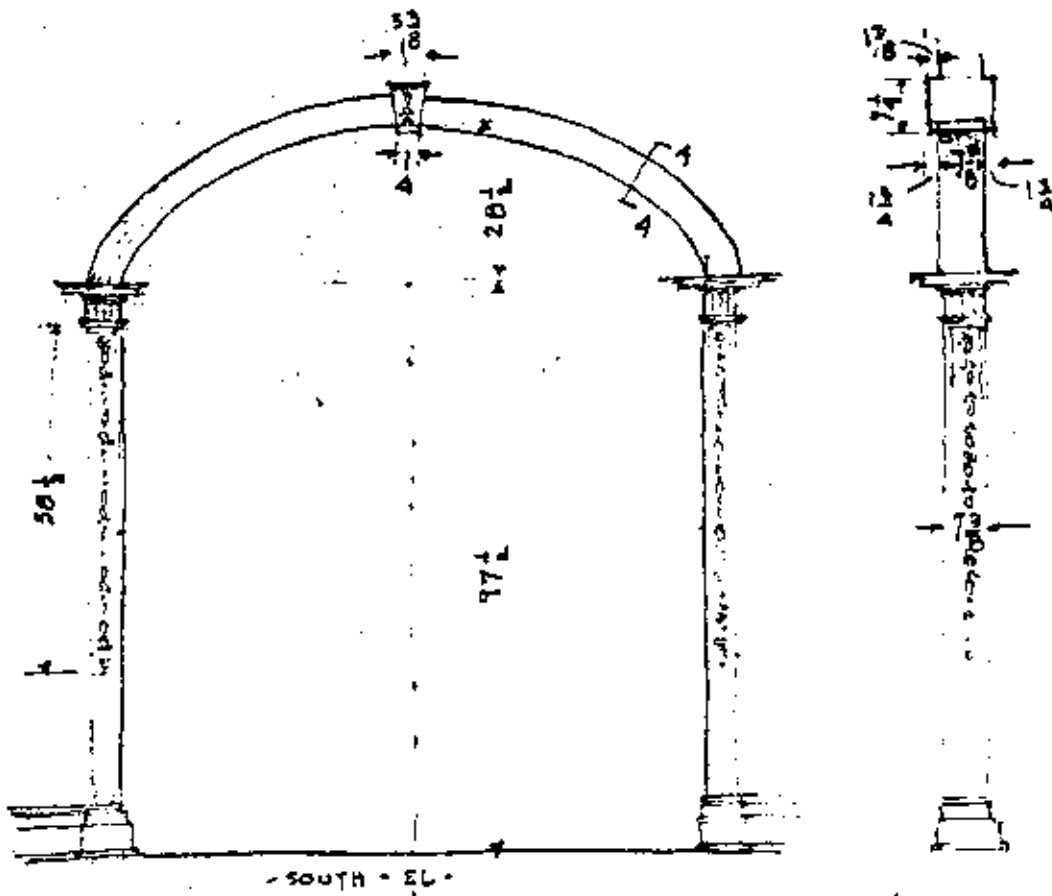

- SOUTH - EL -

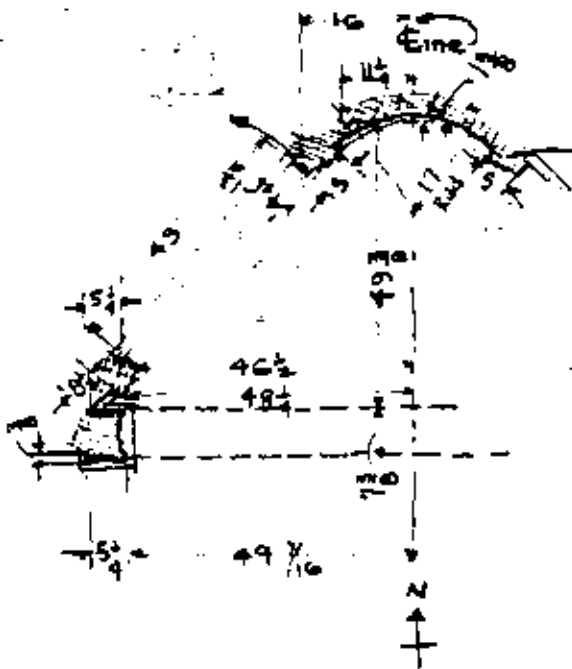

Typical Trim: See Page 2 -

- SOUTH - ARCH - 1ST FL.

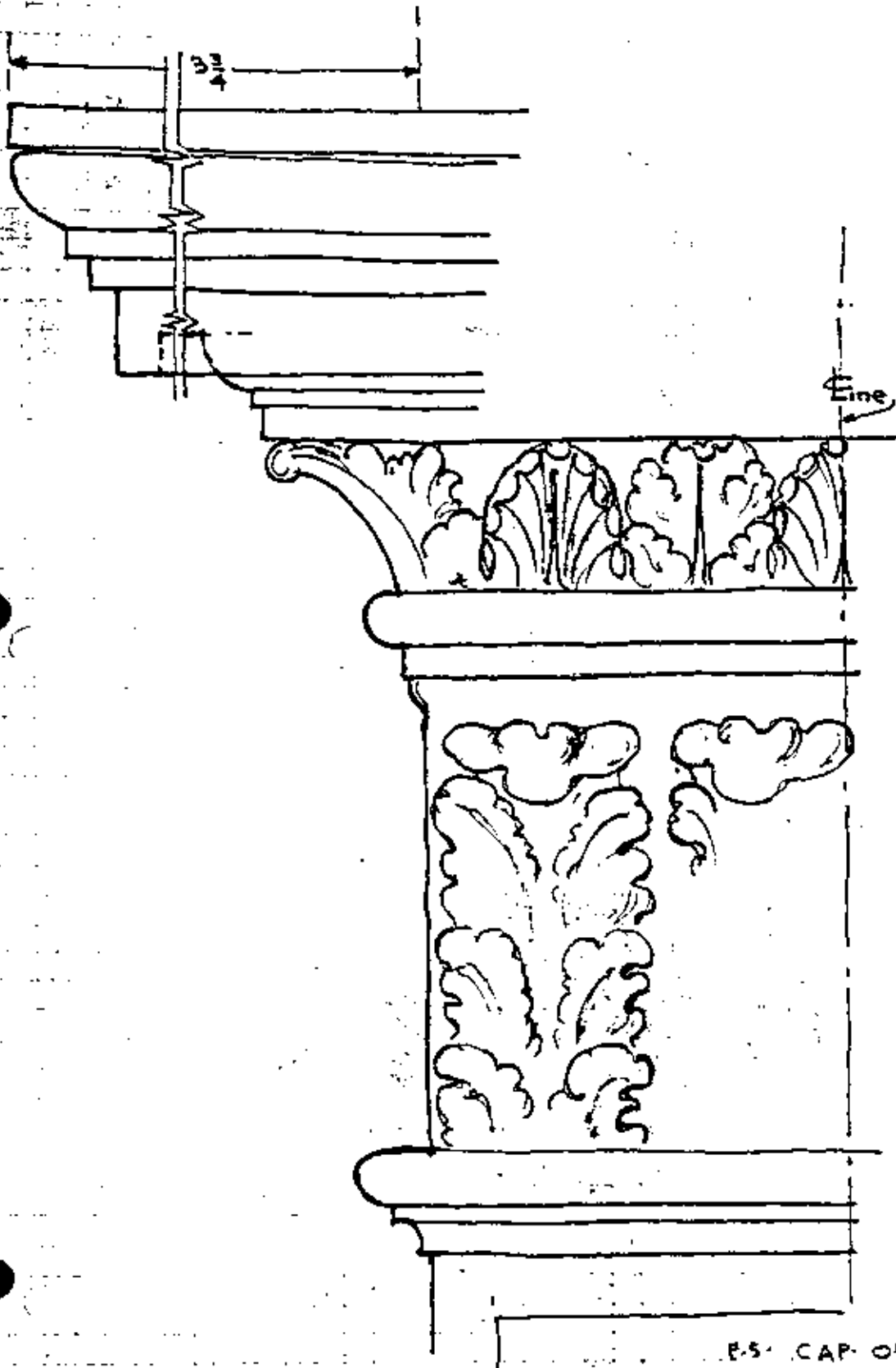

E.S. CAP. OF SOUTH ARCH.
1ST FL.

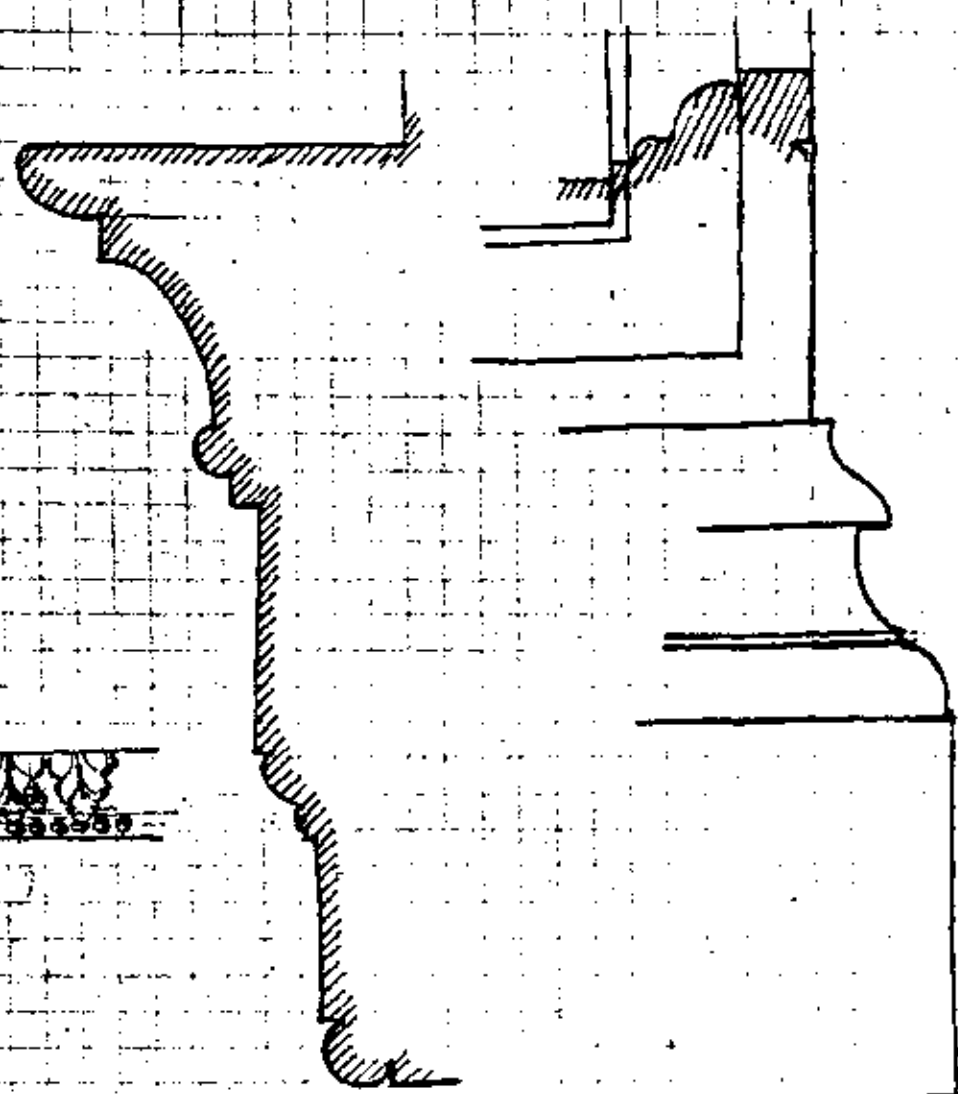

F.S. SECTION A-A

5 1/2

F.S. BASE OF SOUTH ARCH -
1ST FL.

NOTE: HIGHEST PROJECTION OF ORNAMENT IS 1/4"

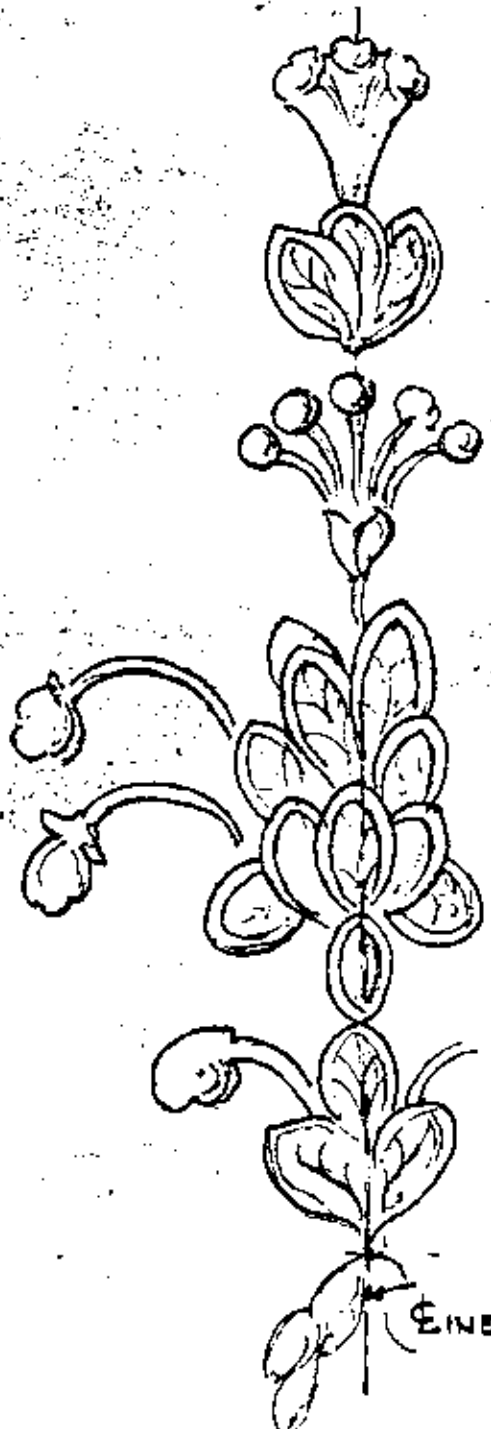
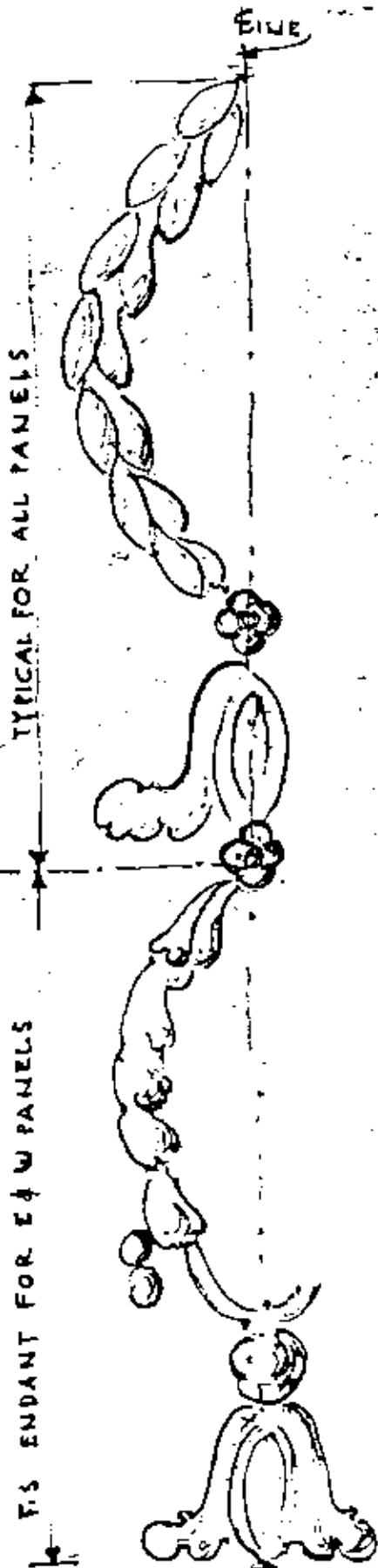

F.S. CROWN FOR ALL PANELS.

- SOUTH ARCH -
- 1ST FL -

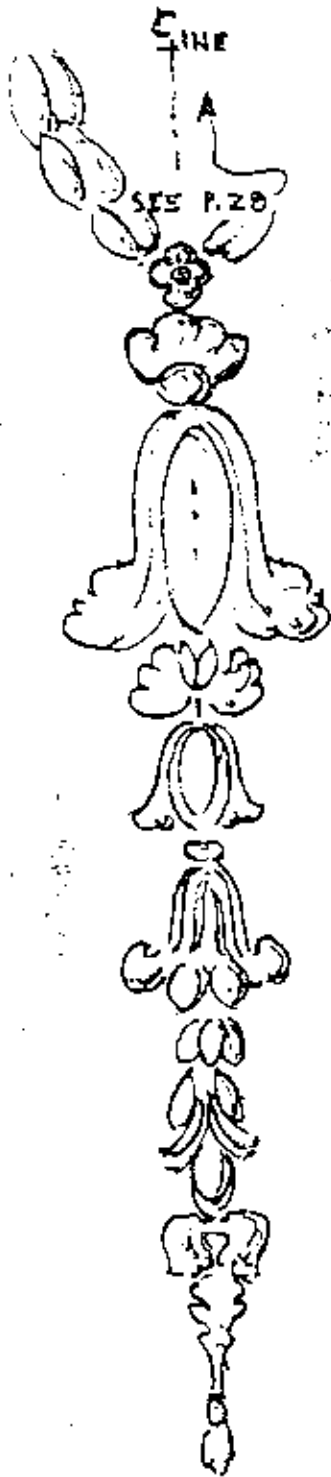

P.S. PENDANT OF ORNAMENT, SOUTH PANELS OF PILASTER.

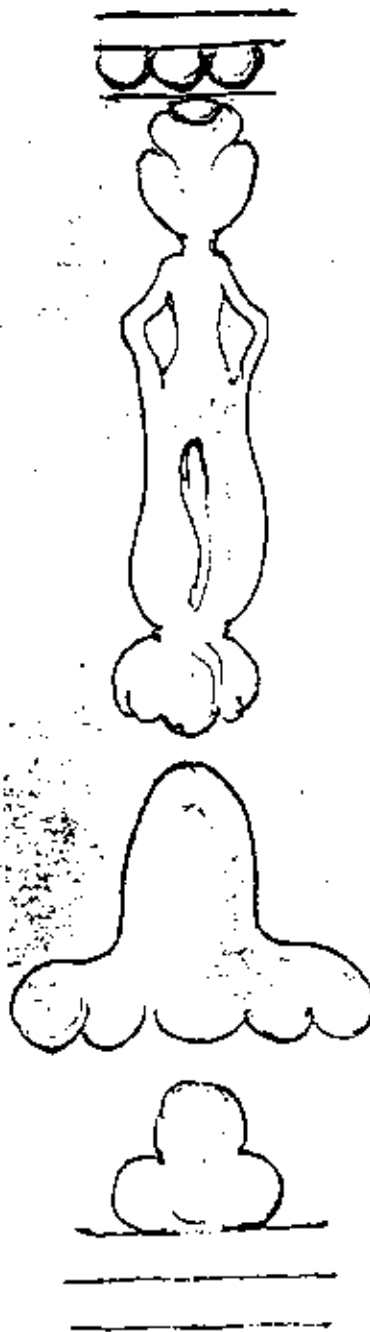

P.S. KEYSTONE ORNAMENT.

SOUTH ARCH -
1ST FL.

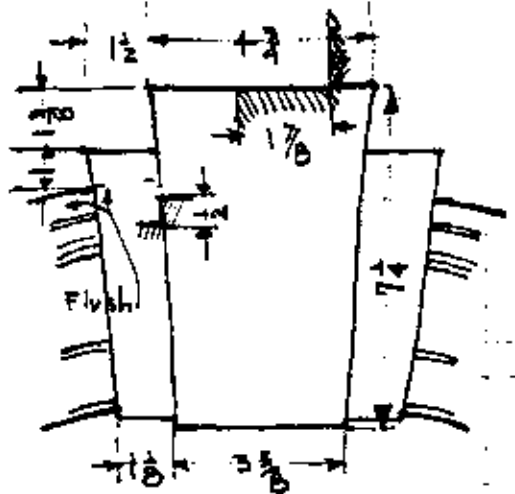
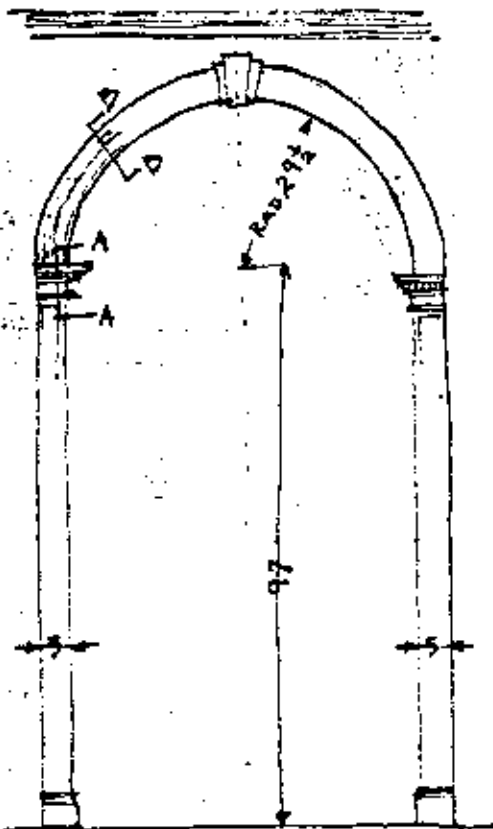

KEYSTONE

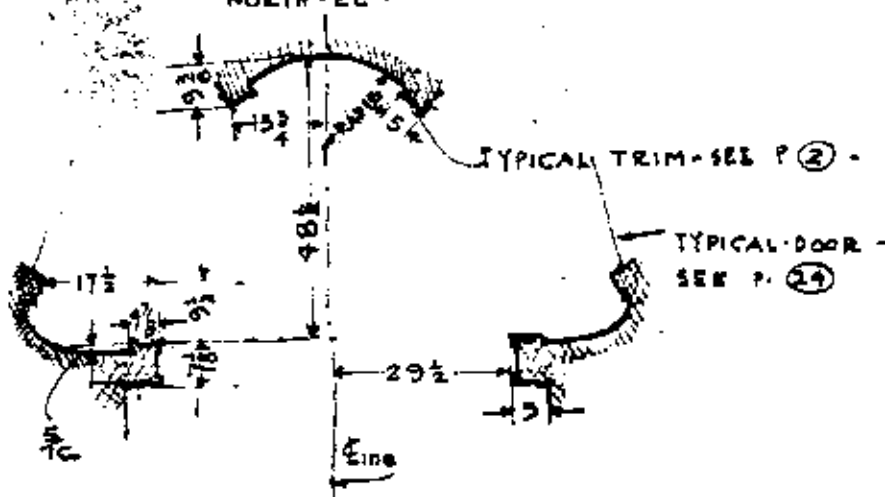

NORTH ARCH - 1ST FL.

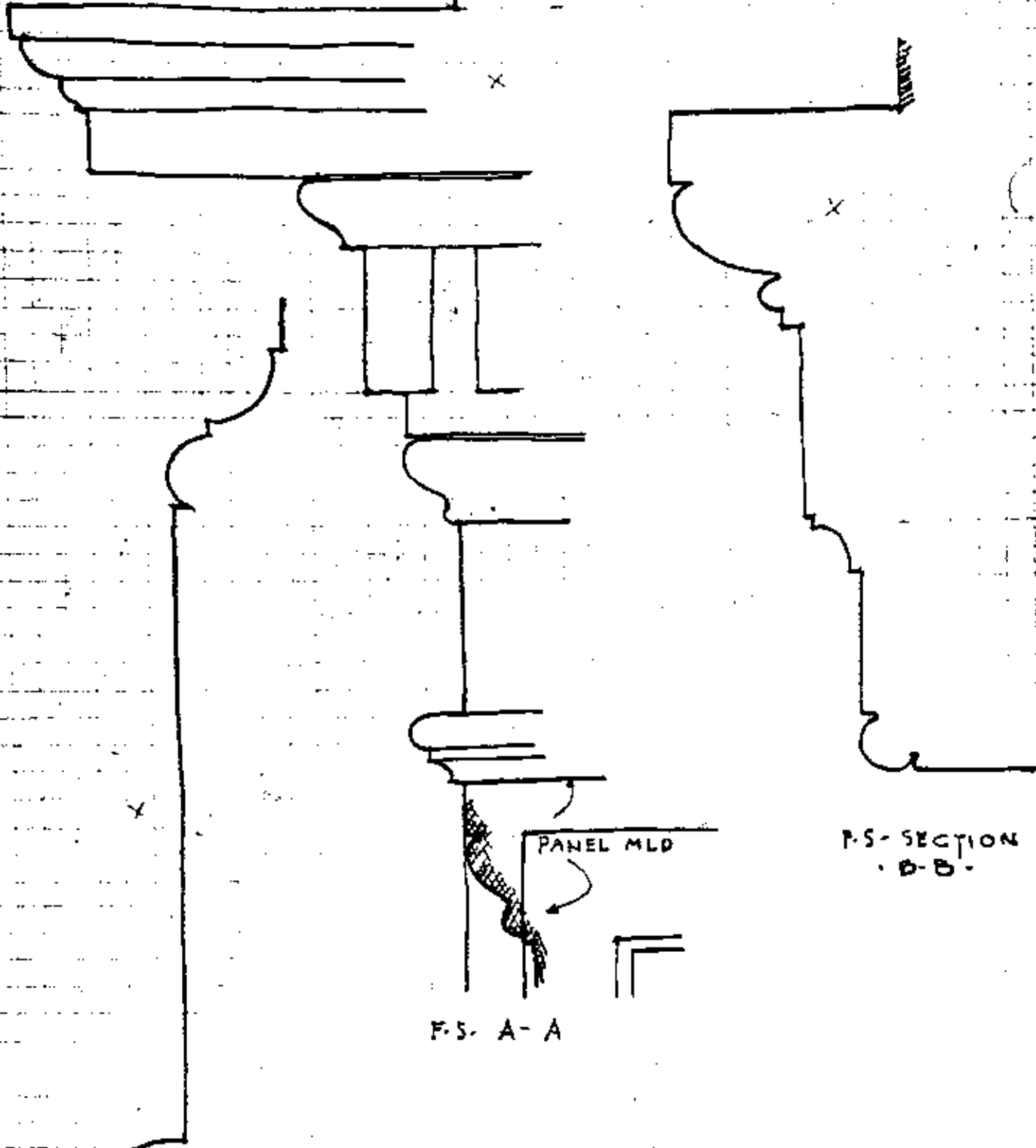

P.S. SECTION - BASE

P.S. - A - A

P.S. SECTION
- B - B -

"NORTH ARCH"
- 1ST FL -

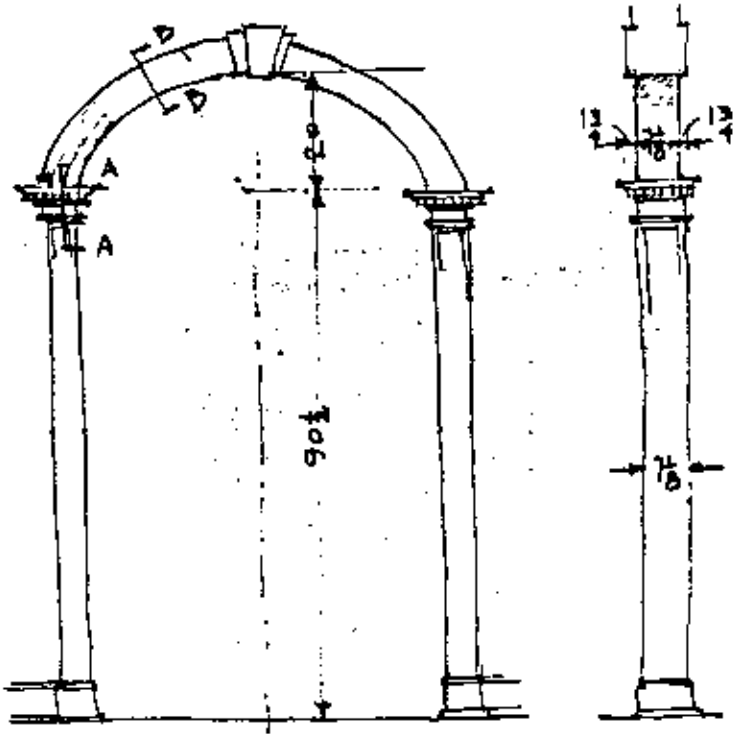

- SOUTH - EL -

NOTES B-D SIMILAR
 TO N-ARCH - 1ST FL -
 BASE DITTO - SEE P. 31
 KEYSTONE DITTO - SEE P. 30

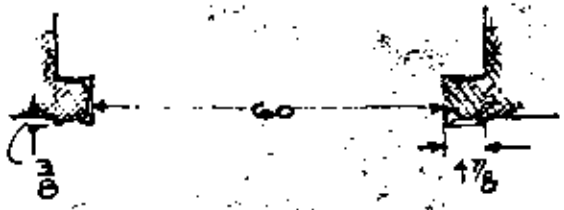

ARCH - 2ND - FL -

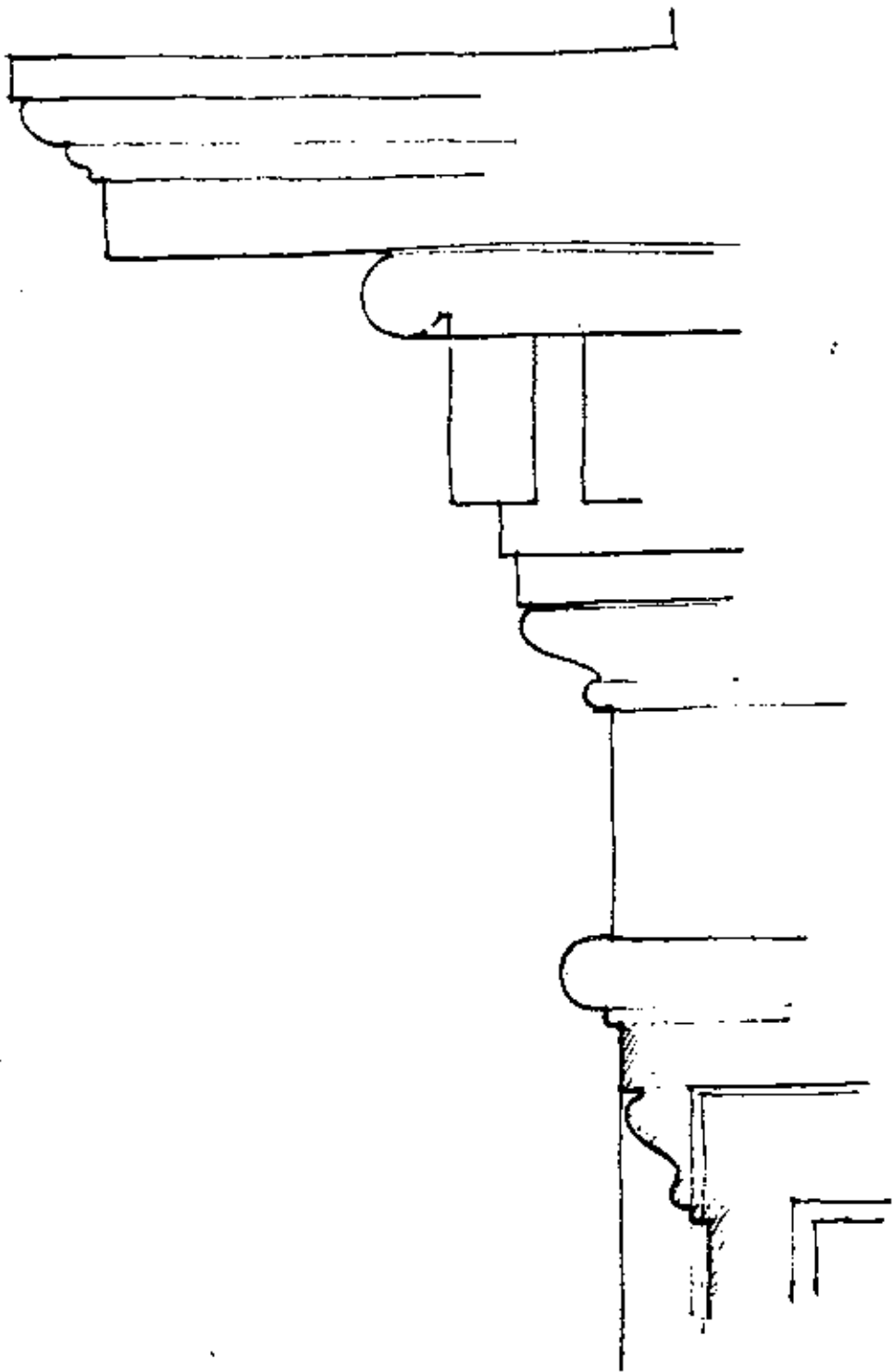

P.S. A-A

-ARCH. 2ND FL.-

Appendix I

Hamilton Grange: Measured Drawings

by G.R.W. Watland

1964

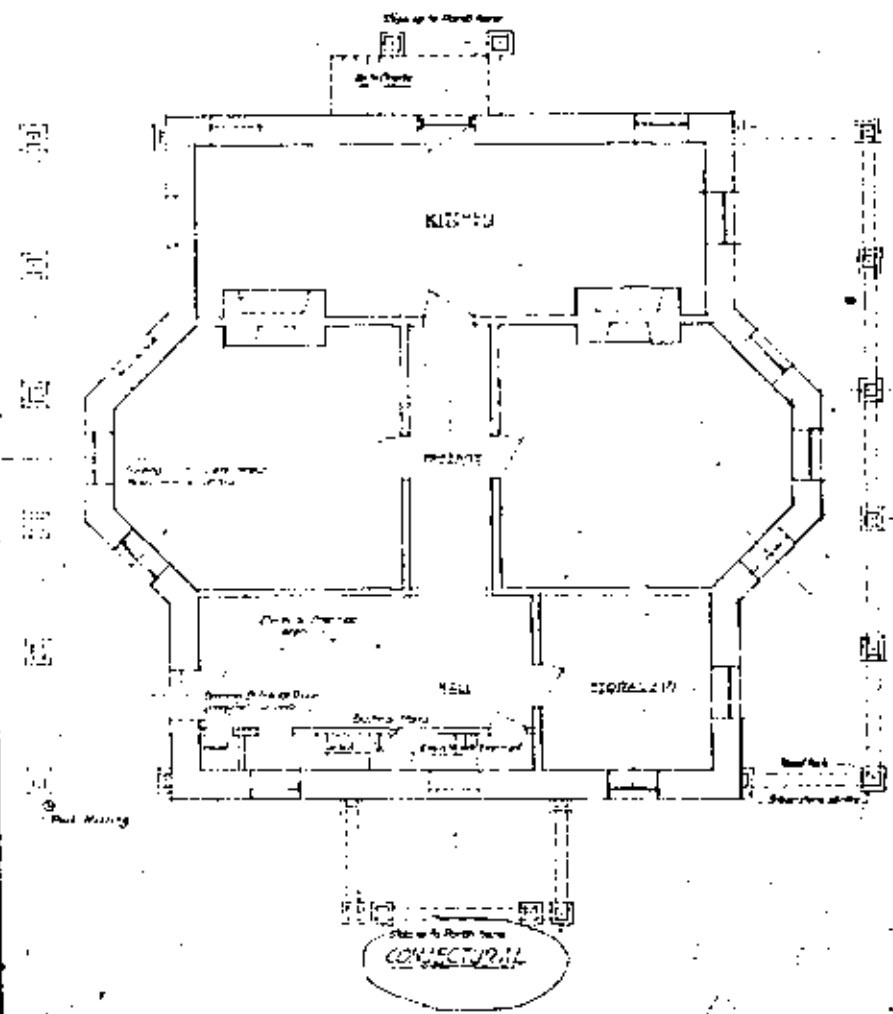

HALF-SIZE REPRODUCTION



ARCHITECTS
THE BUREAU OF RECLAMATION
WASHINGTON, D. C.

APPROVED _____
DATE _____

DEPARTMENT OF THE INTERIOR BUREAU OF RECLAMATION DIVISION OF SURVEYING AND MAPPING		PROJECT NO. _____ DRAWING NO. _____ SHEET NO. _____
TITLE _____ DATE _____	DRAWN BY _____ CHECKED BY _____ APPROVED BY _____	SCALE _____ NORTH ARROW _____

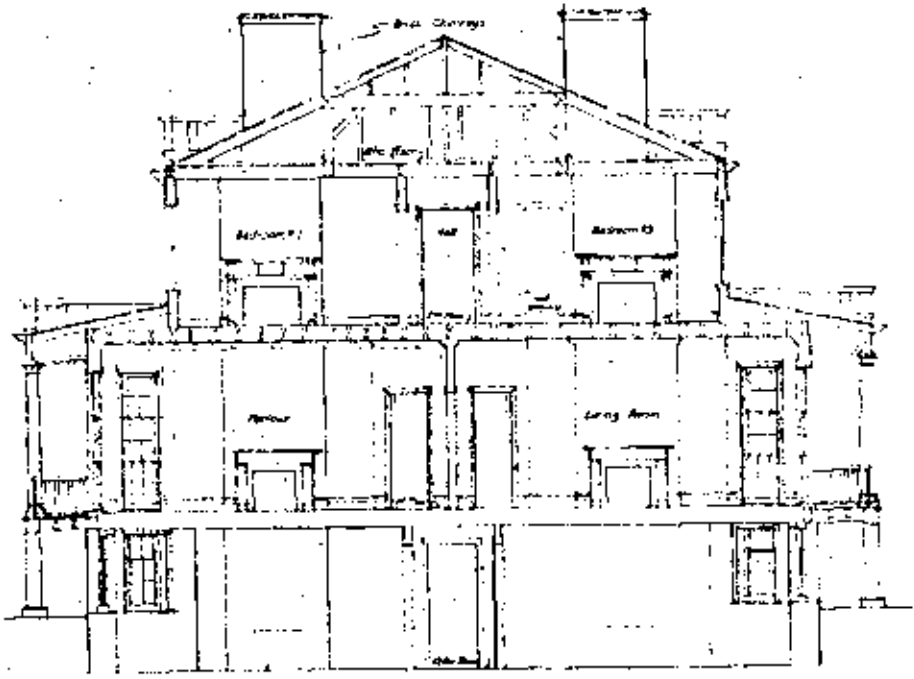
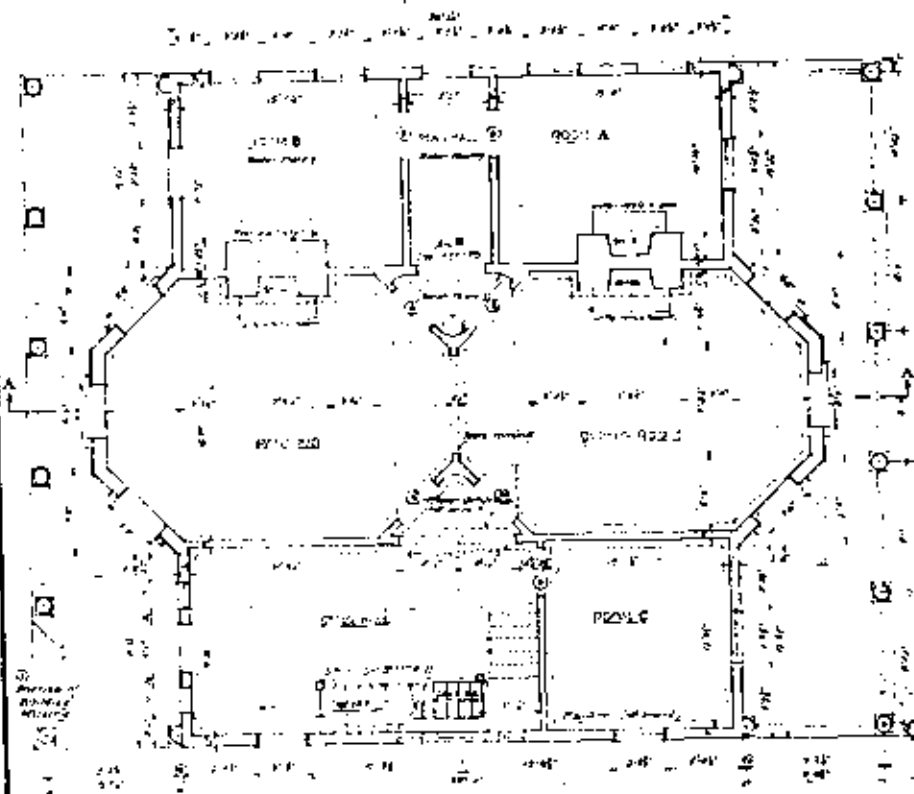

LOOKING NORTH

FIRST FLOOR PLAN & SECTION A-A



APPROVED
ARCHITECT
125 EAST 32nd STREET
NEW YORK 17, N.Y.

DATE	
SCALE	
APPROVED	

DEPARTMENT OF AGRICULTURE
BUREAU OF RECLAMATION
WASHINGTON, D.C.

REVISIONS	
NO.	DATE
1	
2	
3	
4	
5	
6	
7	
8	
9	
10	

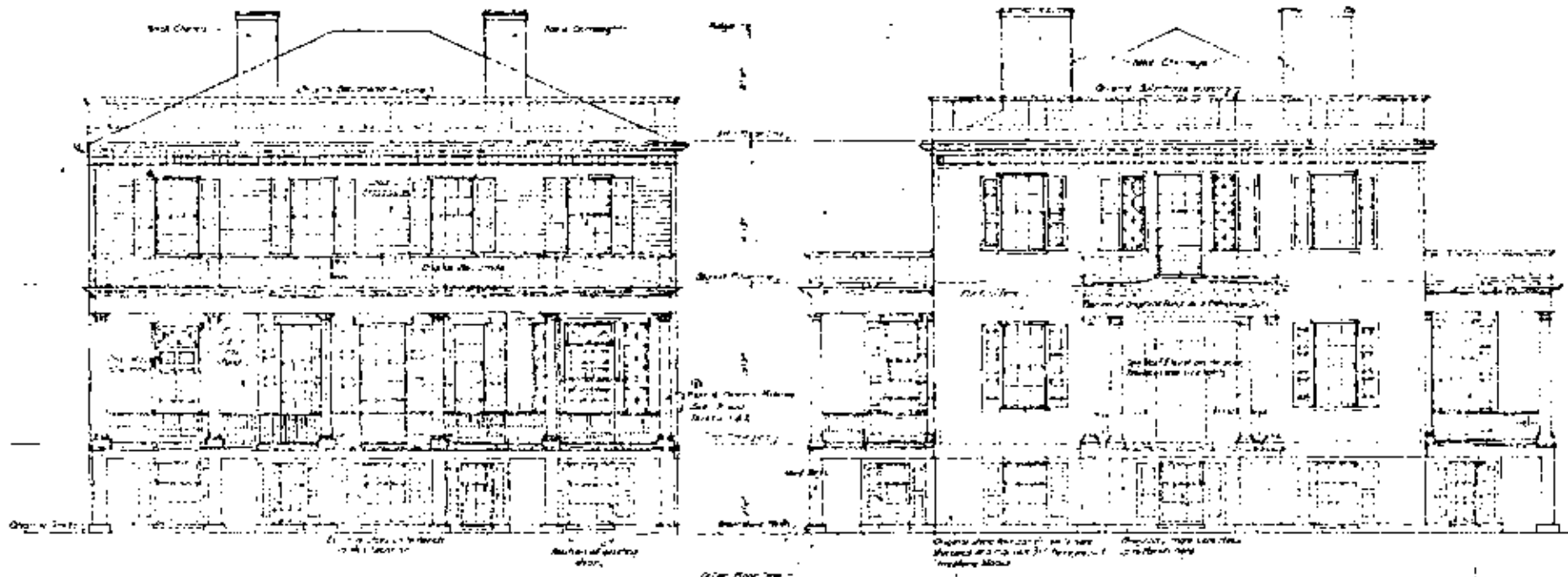

WEST

SOUTH

WEST & SOUTH - ELEVATIONS



ORIGINATED
AT
300 East 34th Street
New York 17, N.Y.

APPROVED

DATE

DESCRIPTION OF SECTION

U.S. STATE
DEPARTMENT OF THE INTERIOR
BUREAU OF LAND MANAGEMENT
DIVISION OF SURVEY AND MAPPING
WASHINGTON, D.C.

SECTIONED DRAWING OF SURVEY SECTION
AND BEARING OF SURVEY SECTION
AND BEARING OF SURVEY SECTION

ON MICROFILM

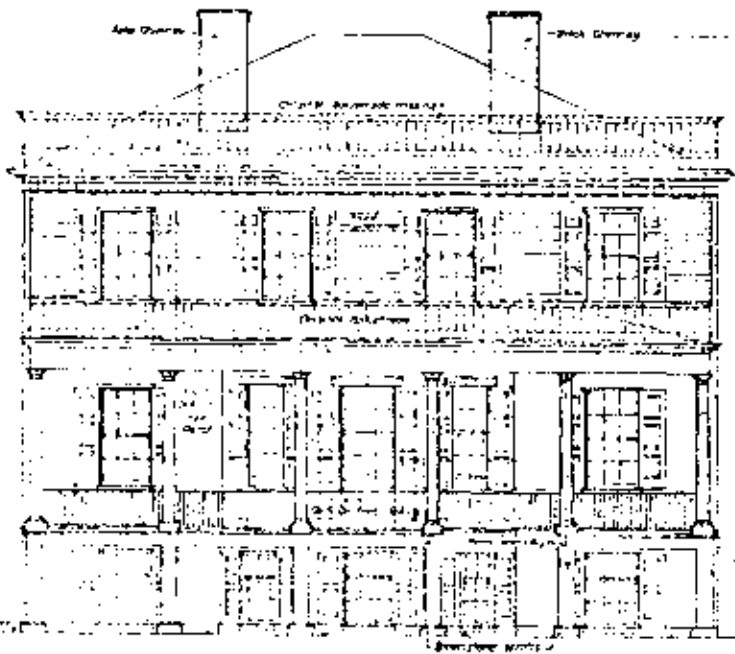

EAST

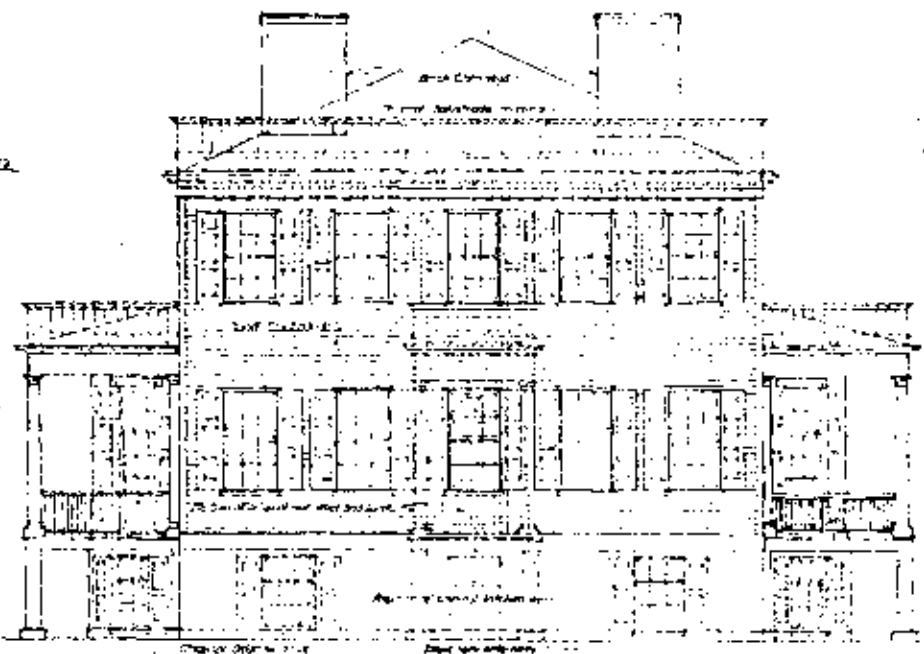

NORTH

EAST & NORTH ELEVATIONS

NO.	DATE	DESCRIPTION OF REVISION



U.S. GEOLOGICAL SURVEY
 WATER RESOURCES DIVISION
 1225 G ST. N.W.
 WASHINGTON, D.C. 20004

SCALE: 1/4" = 1'-0"
 DRAWN BY: []
 CHECKED BY: []
 APPROVED BY: []

UNITED STATES
 DEPARTMENT OF THE INTERIOR
 GEOLOGICAL SURVEY
 WATER RESOURCES DIVISION
 1225 G ST. N.W.
 WASHINGTON, D.C. 20004
 40007-A
 10-1974

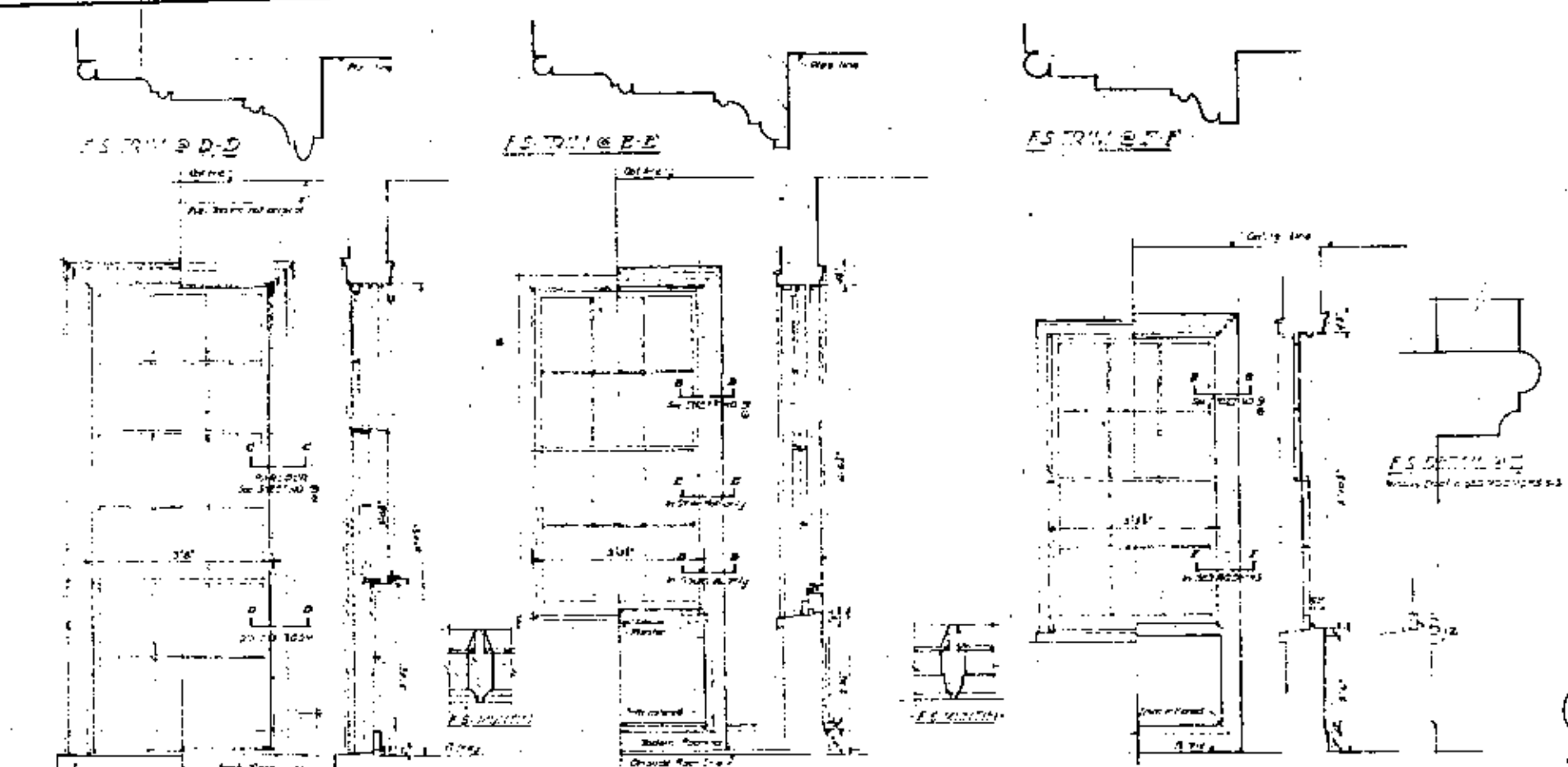

SECTION
FIRST FLOOR WINDOW

SECTION
FIRST FLOOR WINDOW

SECTION
SECOND FLOOR WINDOW

E.S. DETAIL @ D-D
Window Detail @ Section D-D

WINDOW DETAILS

NO.	DESCRIPTION OF REVISION	DATE
1	REVISION	
2	REVISION	
3	REVISION	
4	REVISION	
5	REVISION	
6	REVISION	
7	REVISION	
8	REVISION	
9	REVISION	
10	REVISION	



U.S. GOVERNMENT
DEPARTMENT OF THE INTERIOR
BUREAU OF RECONSTRUCTION
WASHINGTON, D.C.

APPROVED
DATE

U.S. GOVERNMENT
DEPARTMENT OF THE INTERIOR
BUREAU OF RECONSTRUCTION
WASHINGTON, D.C.

REVISIONS
NO. 1
NO. 2
NO. 3
NO. 4
NO. 5
NO. 6
NO. 7
NO. 8
NO. 9
NO. 10

ESTIMATED

ESTIMATED

ESTIMATED

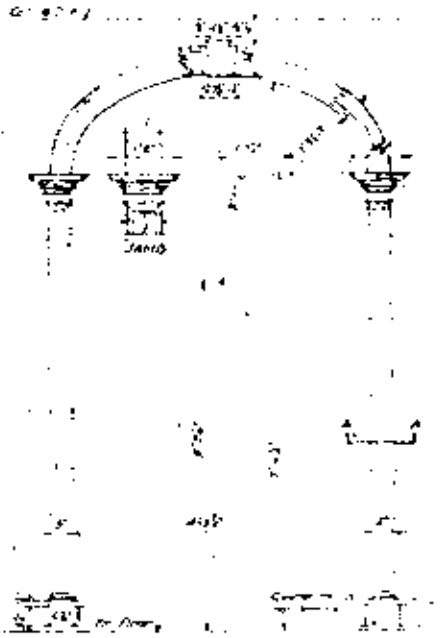
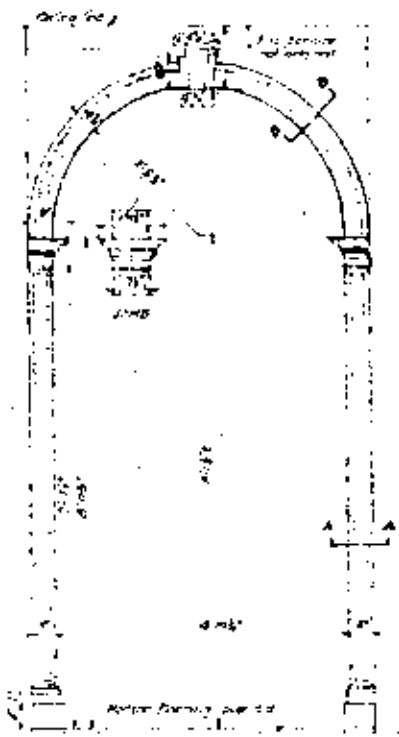
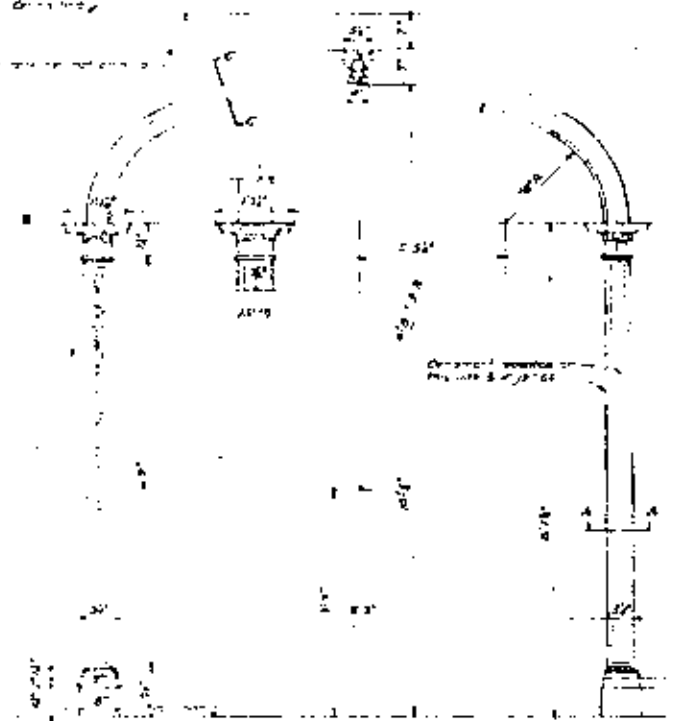

ENTRANCE HALL ARCH
Scale: 1/4" = 1'-0"

ARCH IN HALL

ARCH IN HALL

ARCH DETAILS



ORVINGLAND
Architect
329 East 87th Street
New York City
New York

APPROVED

DESCRIPTION OF PROJECT	
NO.	110-111
NAME	DEPARTMENT OF THE INTERIOR
DATE	APRIL 1910
BY	JOHN W. H. ...
CHECKED	...
APPROVED	...

REVISIONS	
NO.	DESCRIPTION
1	...
2	...
3	...
4	...
5	...

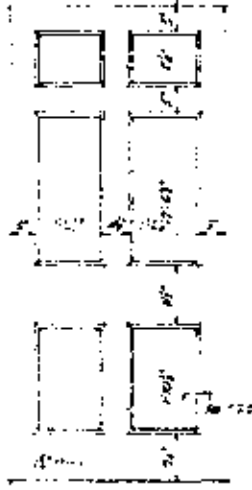

TYPE A



TYPE B

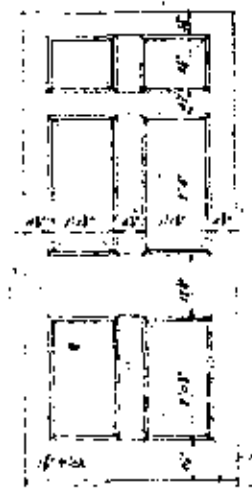

TYPE C



TYPE D



TYPE E



TYPE F

1ST FLOOR

2ND FLOOR

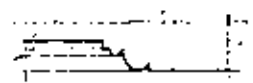

TYPICAL PARALLEL WALL

GENERAL INVESTIGATION
 DIVISION
 FEDERAL BUREAU OF INVESTIGATION
 U.S. DEPARTMENT OF JUSTICE

UNITED STATES DEPARTMENT OF JUSTICE

PROJECT NO.	
DATE	
SCALE	
DESCRIPTION OF PROJECT	



GUY W. HANCOCK
 ARCHITECT
 1200 L STREET, N.W.
 WASHINGTON, D.C. 20004

REVISIONS	
APPROVED	

UNITED STATES DEPARTMENT OF JUSTICE FEDERAL BUREAU OF INVESTIGATION DIVISION OF COMMUNICATIONS AND CONTROL	DATE DRAWN BY CHECKED BY APPROVED BY SPECIAL AGENT IN CHARGE
---	--

REVISIONS	
NO.	DATE
1	
2	
3	
4	
5	
6	
7	
8	
9	
10	

Appendix J

Hamilton Grange: Restoration Drawings

by Newton P. Bevin

1964

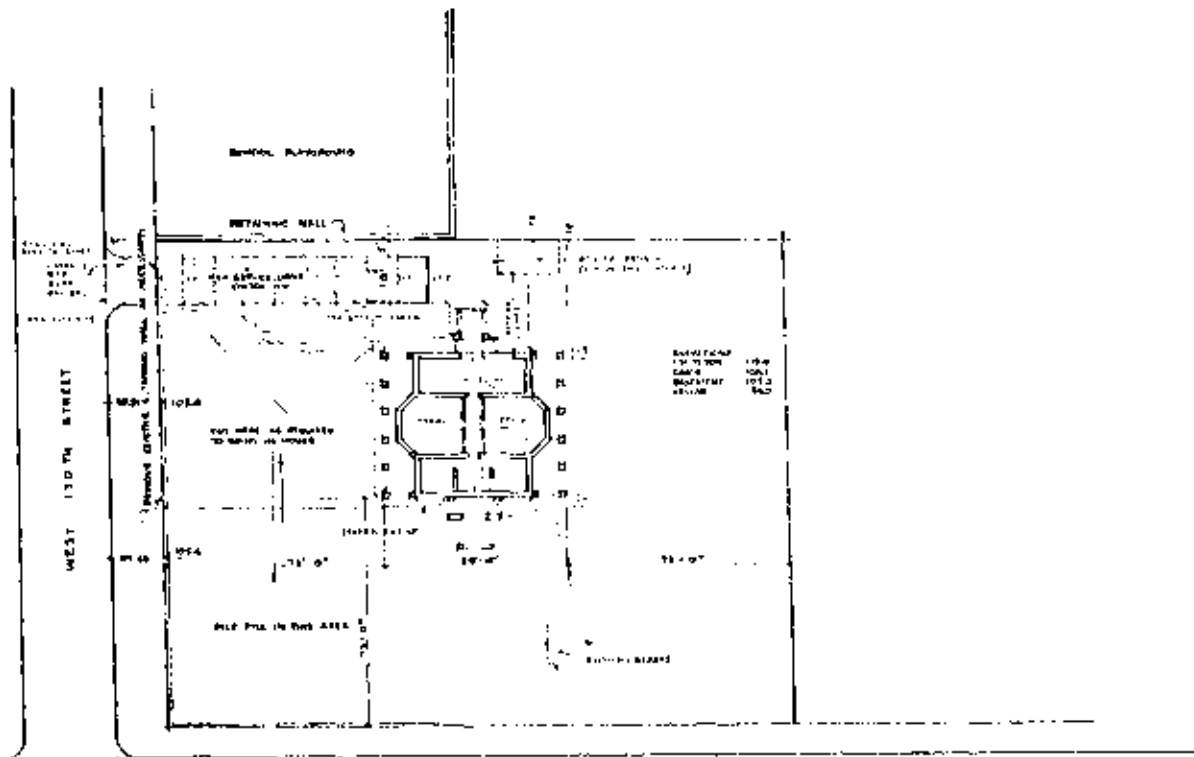

ST. NICHOLAS TERRACE



ROUTE OF MOVE

HALF-SIZE REPRODUCTION

WORKING DRAWING

SITE PLAN

	UNITED STATES DEPARTMENT OF THE INTERIOR NATIONAL PARK SERVICE	PREPARED BY ARCHITECT NATIONAL PARK SERVICE
		DATE 1954
APPROVED BY SUPERVISOR NATIONAL PARK SERVICE	CHECKED BY ARCHITECT NATIONAL PARK SERVICE	DRAWN BY ARCHITECT NATIONAL PARK SERVICE



REVISIONS NO. 1 DATE 1954

1258

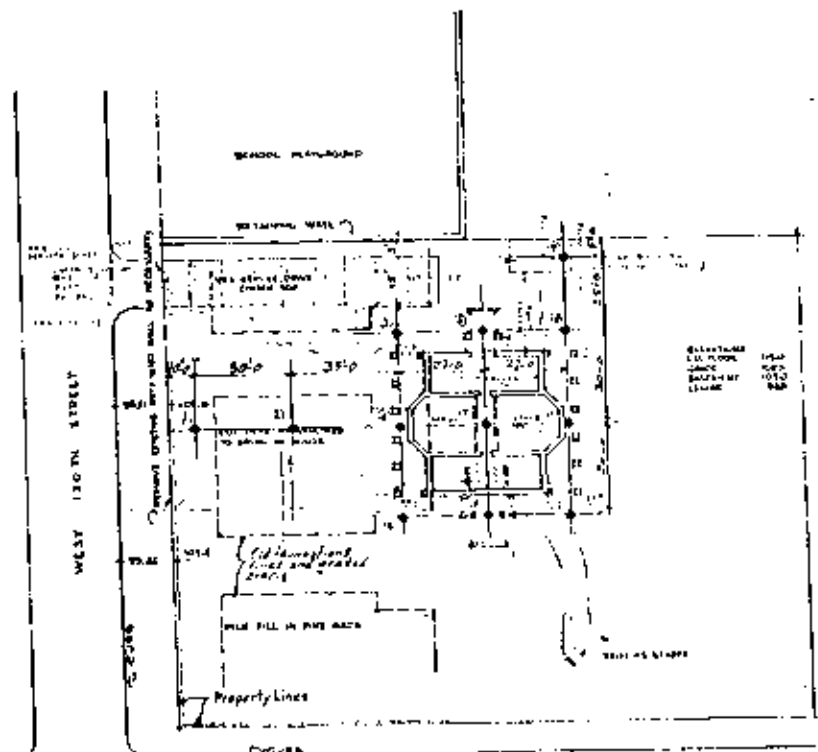

- NOTE FOR BORINGS**
1. Refer to the 1944 and 1952 site plans for locations of borings.
 2. Borings are to be made at the locations shown on the 1944 and 1952 site plans. The borings are to be made at the locations shown on the 1944 and 1952 site plans. The borings are to be made at the locations shown on the 1944 and 1952 site plans.
 3. The borings are to be made at the locations shown on the 1944 and 1952 site plans. The borings are to be made at the locations shown on the 1944 and 1952 site plans.
 4. The borings are to be made at the locations shown on the 1944 and 1952 site plans. The borings are to be made at the locations shown on the 1944 and 1952 site plans.
 5. The borings are to be made at the locations shown on the 1944 and 1952 site plans. The borings are to be made at the locations shown on the 1944 and 1952 site plans.



BORING LOCATIONS

SITE PLAN

WORKING DRAWING

SCALE 1/2" = 1'-0"



HE MOURN T. DAVIN
ARCHITECT
104 EAST 57th ST.
NEW YORK 10, N. Y.

APPROVED

UNITED STATES
DEPARTMENT OF THE INTERIOR
NATIONAL PARK SERVICE
DESIGN AND CONSTRUCTION
DIVISION
EASTERN
OFFICE
WASHINGTON, D. C.

ST. NICHOLAS TERRACE, NEW YORK, N. Y.

SPECIAL AGENT IN CHARGE

DATE

PREPARED BY
R. J. SMITH
E. J. HULL
N. J. DEWITT

SCALE
1/2" = 1'-0"

REVISIONS

APPROVED

DATE

BY

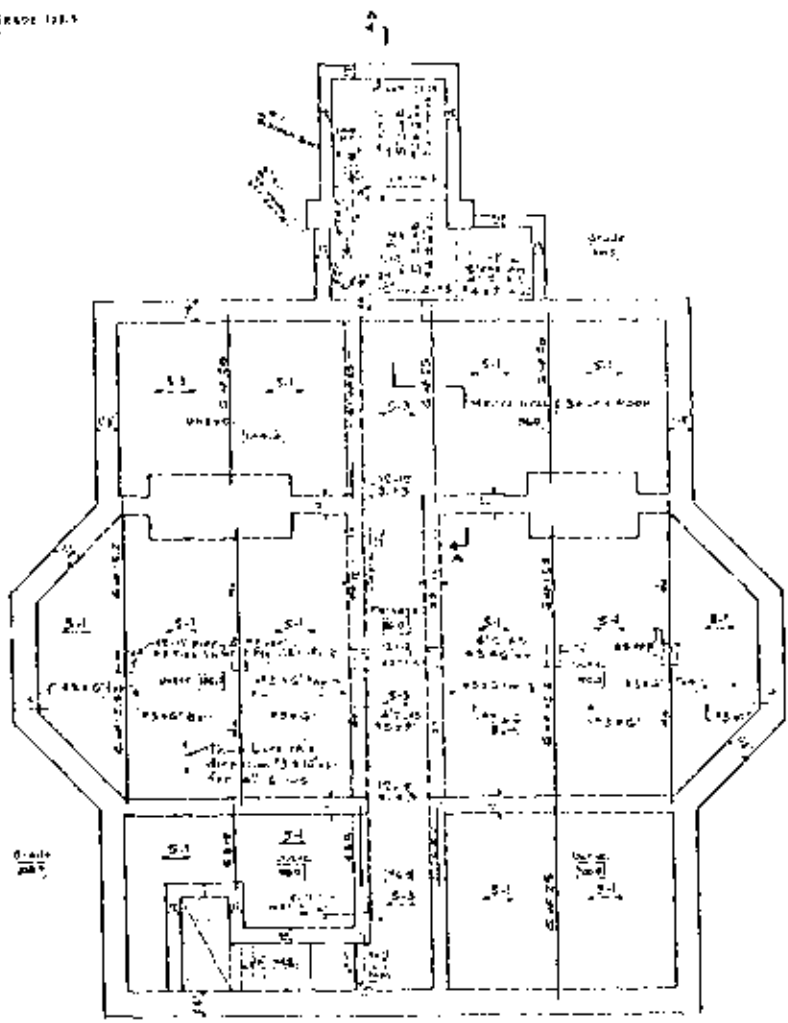
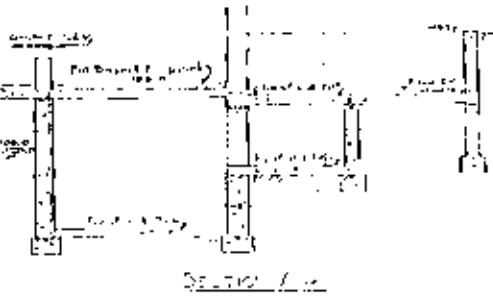

CELLAR 100.0
 FINISHED GRADE 118.0
 GRADE 100.0
 UNBYS. SPEC 100.0

CELLAR PLAN
SHOWING FINISHED GRADE



NEWTON A. DORN
 ARCHITECT
 154 EAST 63RD
 NEW YORK 21, N.Y.

DATE	_____
SCALE	1/4" = 1'-0"
PROJECT	_____

DESCRIPTION OF REVISION	
NO.	DESCRIPTION



PREPARED BY	_____
CHECKED BY	_____
DATE	_____
REVISION	_____

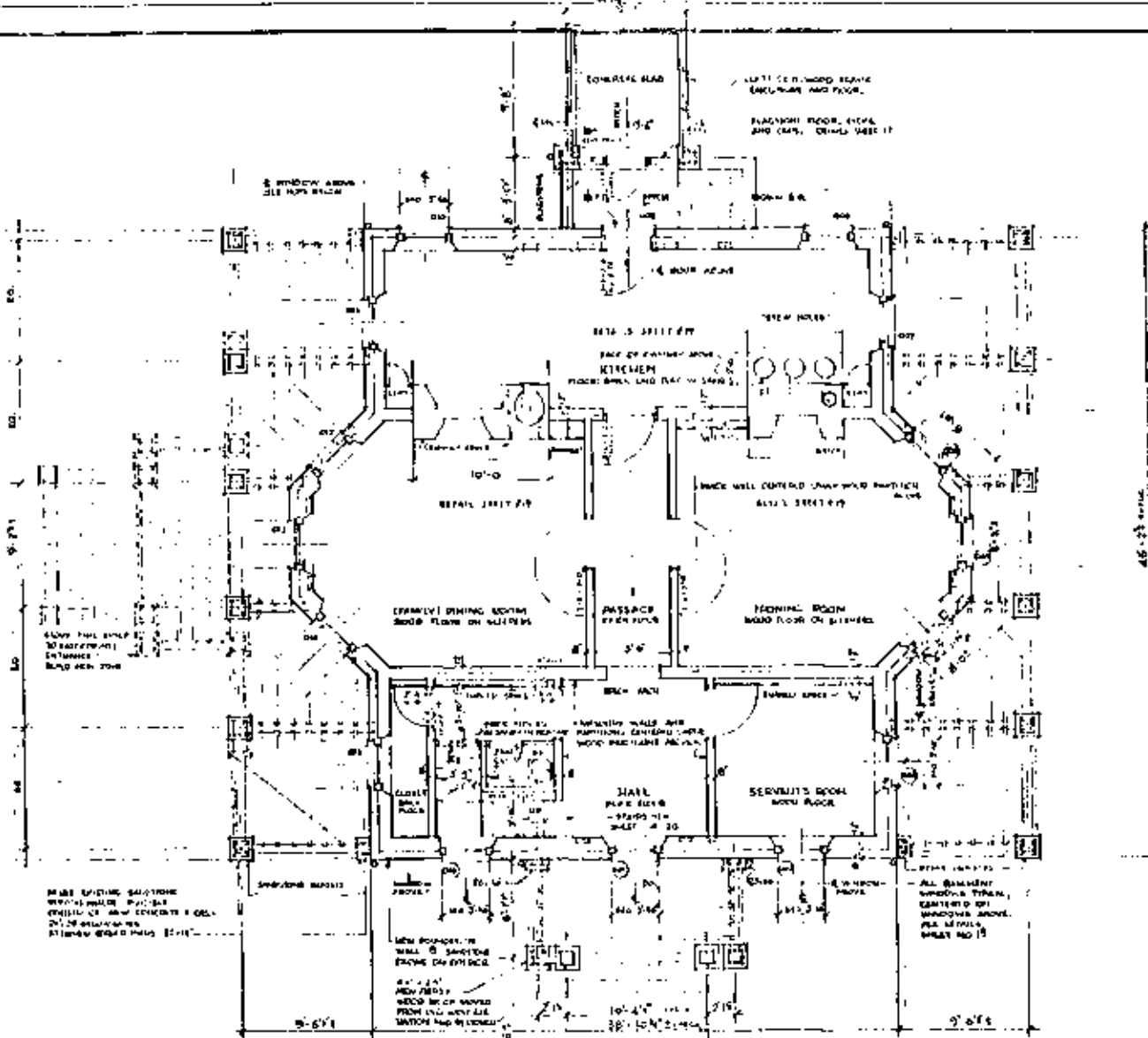

6'00" WALL ONLY TO RESTROOM ENTRANCE. BRICK AND CONCRETE.

REMOVE EXISTING WALLS AND PARTITION. CONCRETE FLOOR. BRICK AND CONCRETE. NEW WOOD FLOOR.

NEW WOOD FLOOR. REMOVE WALL AND PARTITION. CONCRETE FLOOR. BRICK AND CONCRETE. NEW WOOD FLOOR.

REMOVE WALL AND PARTITION. CONCRETE FLOOR. BRICK AND CONCRETE. NEW WOOD FLOOR.

KEY
 BATH
 DINING ROOM
 KITCHEN
 RESTROOM
 SERVANTS ROOM
 JEWELRY



NEW YORK DESIGN ARCHITECT 104 EAST 64 ST NEW YORK 24 NY

SCALE 1/4" = 1'-0"

APPROVED	
----------	--

ALL DIMENSIONS TO BE VERIFIED AT DRAWING BOARD SCALE AND FIELD NOTES. FOUNDATION TO BE CONSULTED WITH HOUSE TO OBTAIN NEW SETS.

BASEMENT FLOOR PLAN

NO.	DESCRIPTION OF REVISION	BY	DATE
1	PREPARED	NEW YORK DESIGN	10/15/38
2	REVISION	NEW YORK DESIGN	10/15/38
3	REVISION	NEW YORK DESIGN	10/15/38
4	REVISION	NEW YORK DESIGN	10/15/38
5	REVISION	NEW YORK DESIGN	10/15/38

UNITED STATES DEPARTMENT OF THE INTERIOR NATIONAL PARK SERVICE REGIONAL OFFICE, ALBANY, NEW YORK

RECEIVED 10/15/38

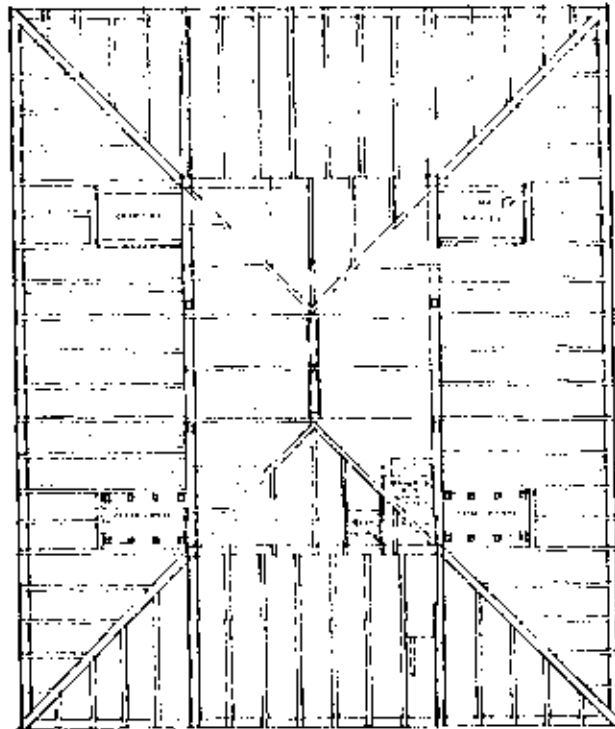

ROOF FRAMING PLAN, ONLY WHEN NECESSARY

7/2/38



ROOF FRAMING PLAN

DATE: _____

DESCRIPTION OF WORK:

BY: _____

DEPARTMENT OF THE INTERIOR
NATIONAL PARK SERVICE

APPROVED: _____

DATE: _____

FOR: _____

REVISIONS:

NO. 1

DATE: _____

BY: _____

REASON: _____

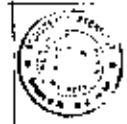

NEWELL F. M. M.
ARCHITECT
134 EAST 81 ST
NEW YORK 21 NY.

WORK ORDER

PREPARED BY: _____

DATE: _____

REVISIONS:

NO. 1

DATE: _____

BY: _____

REASON: _____

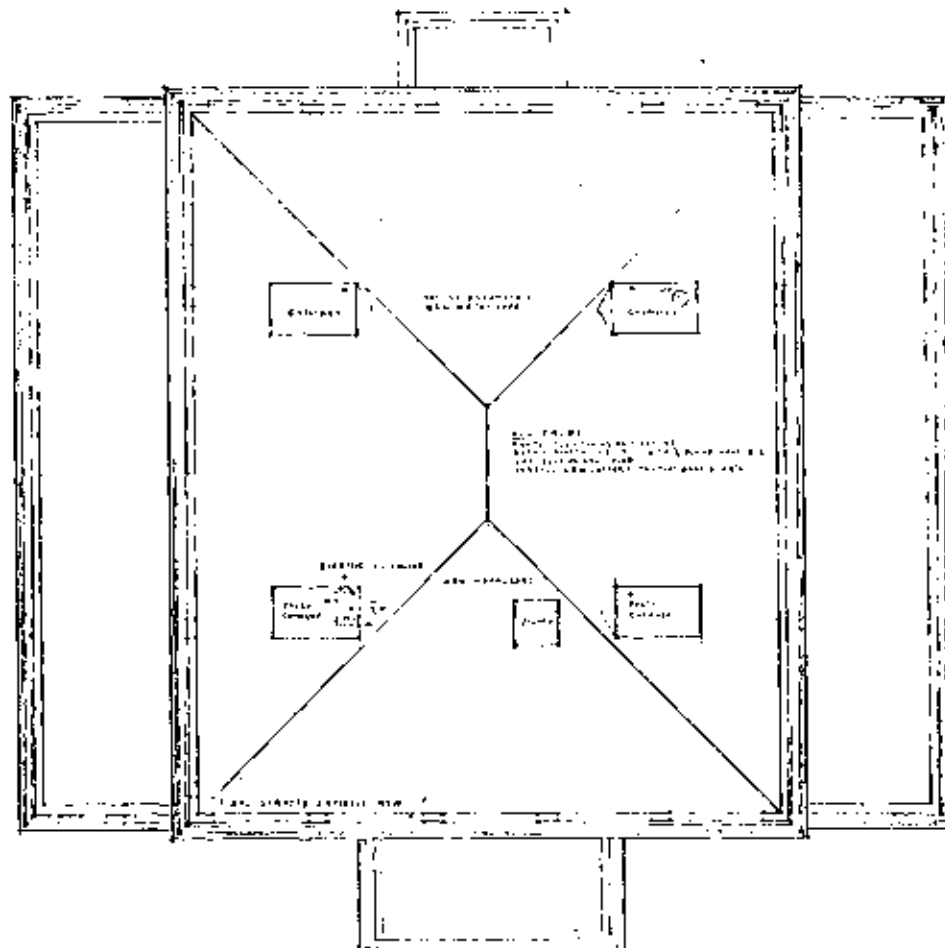

ALL DIMENSIONS IN FEET
 UNLESS OTHERWISE SPECIFIED

ROOF PLAN

NO.	DESCRIPTION

DESCRIPTION OF MEMBER	
UNITED STATES DEPARTMENT OF THE ARMY NATIONAL DEFENSE SERVICE	
MEMBER NO. 101	
DATE OF ISSUE	
DATE OF REVISION	



APPROVED	DATE
<i>[Signature]</i>	



HERMAN K. REYN
 ARCHITECT
 104 EAST 64 ST
 NEW YORK 21, N.Y.

SCALE	1/4" = 1'-0"
APPROVED	

8 of 38

PAV
 (ARTHE WOOD FRAME,
 IN PLACE) TO BE
 DEMOLISHED

NEW PAINTWORK
 ON EXTERIOR WALLS
 TO BE DONE

EXISTING METAL CASE

NEW METAL CASE
 TO BE INSTALLED

BASE LINE

SECOND FLOOR

EXISTING FIRST FLOOR
 ELEV 115.0

TOP OF NEW FLOOR SLAB
 ELEV 105.0

TOP OF NEW FLOOR SLAB
 ELEV 100.0

TOP OF NEW FLOOR SLAB
 ELEV 96.0

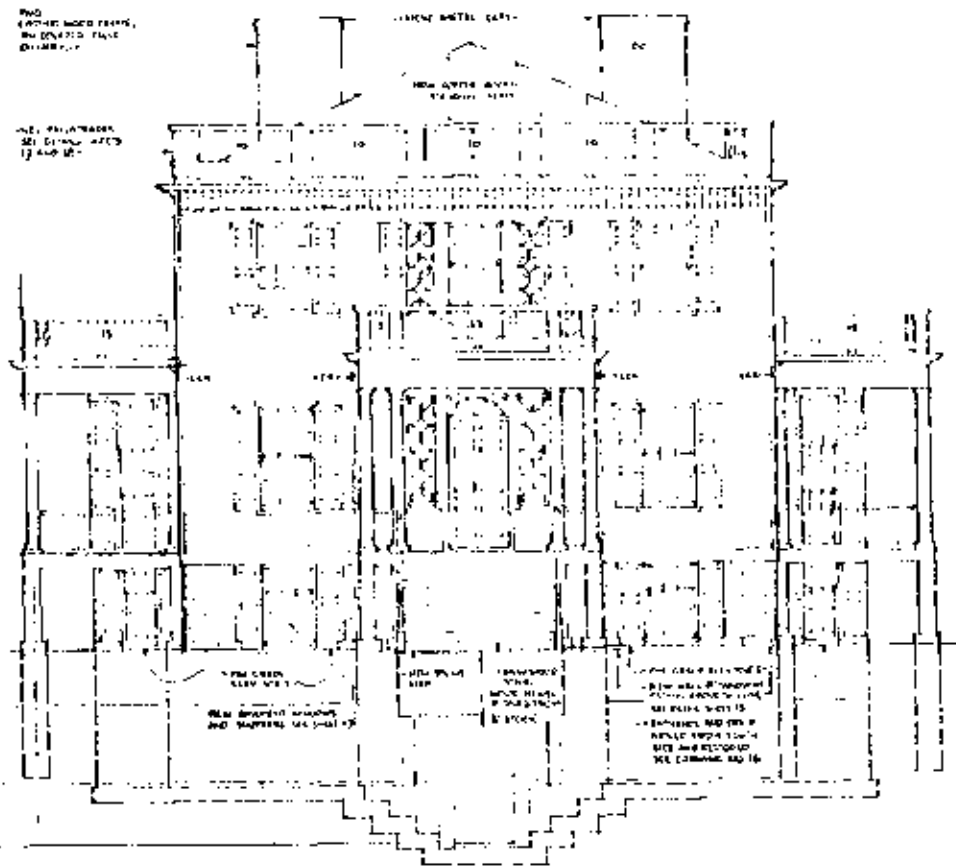

EAST (FRONT) ELEVATION

SCALE 1/4" = 1'-0"



DESIGNED BY
 DRAWN BY
 CHECKED BY
 APPROVED

APPROVED

NO.	DESCRIPTION OF REVISION

PREPARED BY
 CHECKED BY
 DATE
 TITLE
 FIRM

AIRY ROW
 FLOOR FLOOR
 EXISTING FLOOR FINISH
 ELEV 105 0
 NEW FLOOR, NEW BASE, FIN.
 ELEV 105 0
 TOP OF NEW NEW CORNER SPACE
 ELEV 100 0
 TOP OF NEW NEW CORNER
 ELEV 95 0

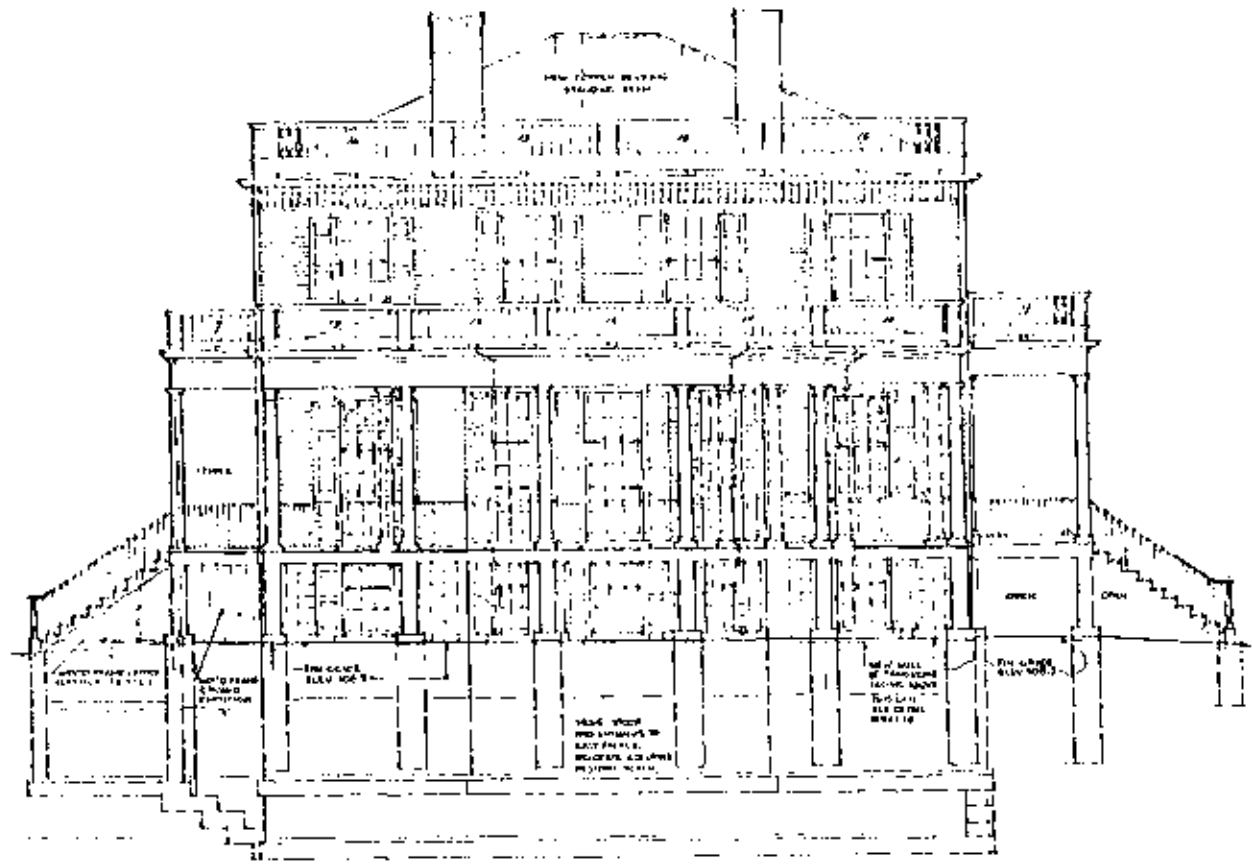

MAKE ONE OF

ALL DETAILS THIS ELEVATION ARE SHOWN EXACTLY AS SHOWN BY EXISTING ELEVATION, DRAW NO. 2
 WITH UNLESS OTHERWISE NOTED TO THE CONTRARY.

SOUTH ELEVATION

NO.	DESCRIPTION OF REVISION	DATE
1	AS NOTED	
2	AS NOTED	
3	AS NOTED	
4	AS NOTED	
5	AS NOTED	
6	AS NOTED	
7	AS NOTED	
8	AS NOTED	
9	AS NOTED	
10	AS NOTED	



NEWSON PEAVIN
 ARCHITECT
 134 EAST 42ND
 NEW YORK, N.Y.

SCALE 1/4" = 1'-0"
 APPROVED _____
 DATE _____

PREPARED BY	NEWSON PEAVIN
CHECKED BY	NEWSON PEAVIN
DATE	
PROJECT NO.	
NO. OF SHEETS	
SHEET NO.	

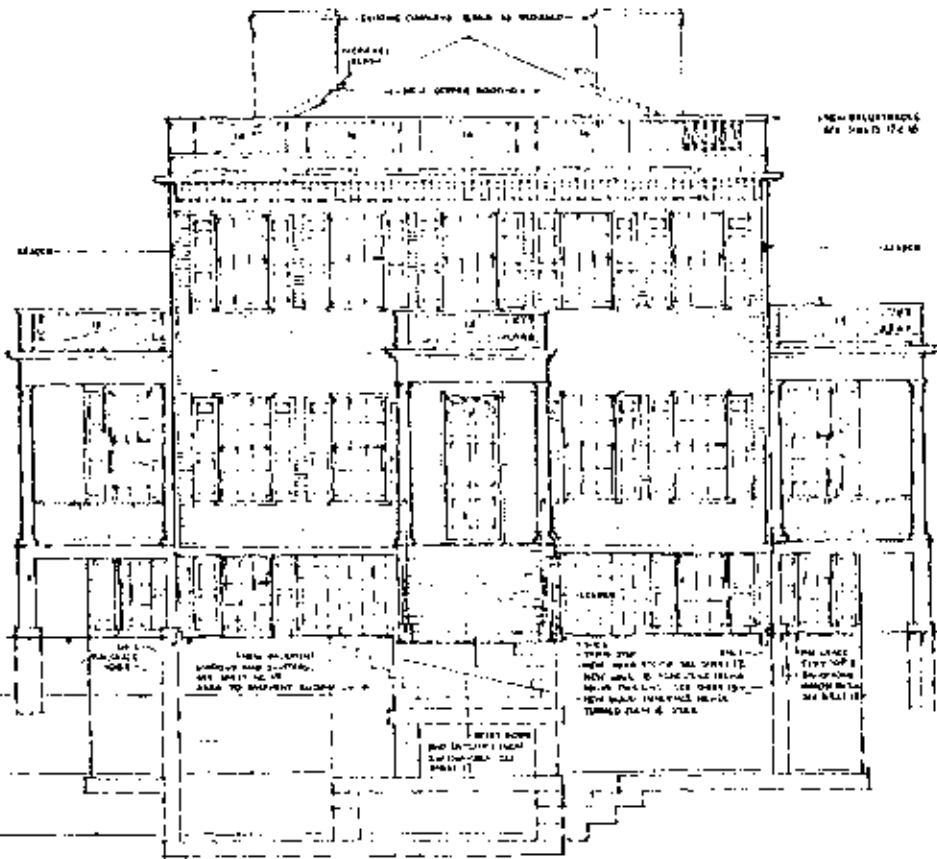

1116' 00.0
 1120' 00.0
 1124' 00.0
 1128' 00.0
 1132' 00.0
 1136' 00.0

SCALE 3/8" = 1'-0"

WEST ELEVATION

ALL DETAILS THIS ELEVATION EXCEPT THE STAIR AS SHOWN IN ELEVATION SHEET NO. 19

SCALE 1/2" = 1'-0"



GEORGE J. LEVY
 ARCHITECT
 154 EAST 6 ST
 NEW YORK 17, N.Y.

APPROVED

NAME	DESCRIPTION OF WORK
	UNITED STATES DEPARTMENT OF THE INTERIOR NATIONAL PARK SERVICE REGIONAL OFFICE

DATE PREPARED	12/1/58
DATE CHECKED	
DATE REVISION	
DATE	

12/1/58

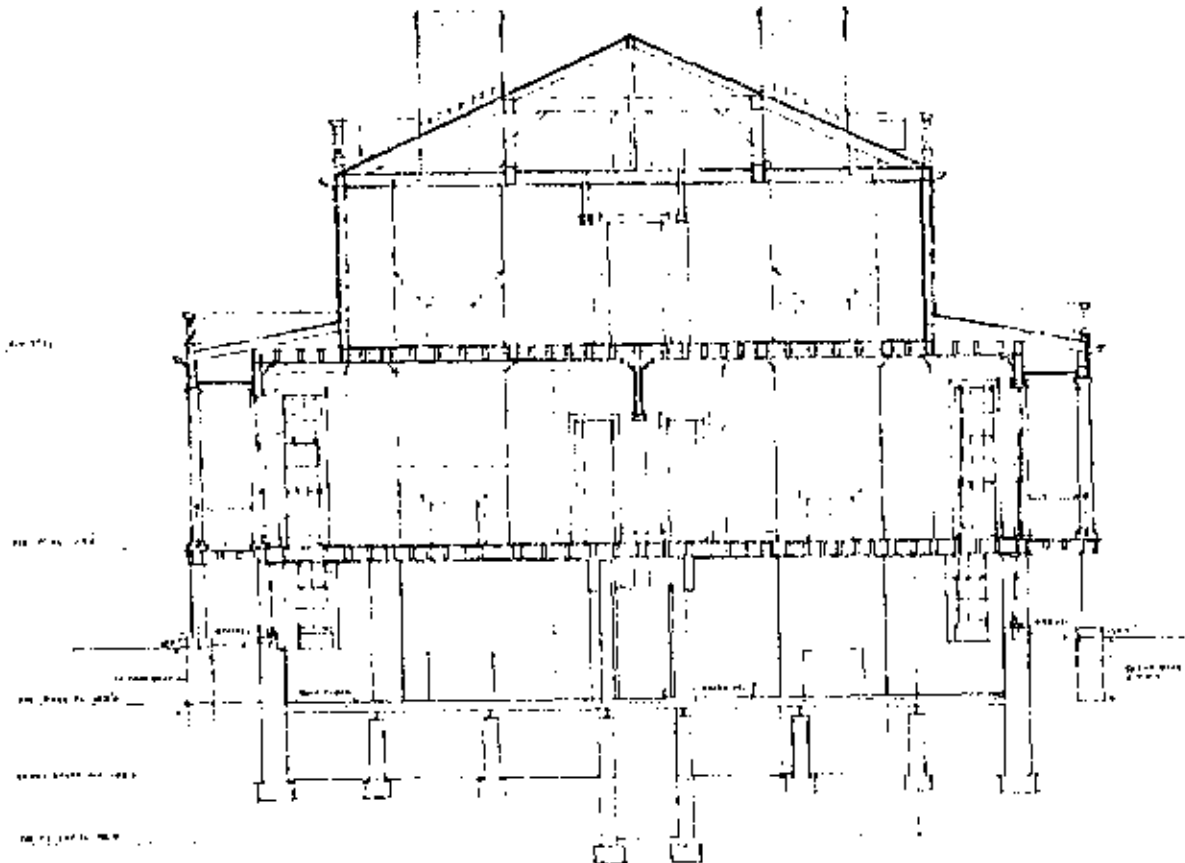

TRIAL-SECTION THROUGH CENTER OF HOUSE

SECTION LOOKING WEST

SCALE 1/4" = 1'-0"



W. L. DIXON, INC.
ARCHITECTS
154 EAST 61 ST
NEW YORK 21, N.Y.

RECORDED	INDEXED
APPROVED	

DATE	DESCRIPTION OF REVISION	BY	APPROVED
12-15-57	ADDED DETAIL OF ROOF TRUSSES	WLD	WLD
12-15-57	REVISION TO ROOF TRUSSES	WLD	WLD
12-15-57	REVISION TO ROOF TRUSSES	WLD	WLD
12-15-57	REVISION TO ROOF TRUSSES	WLD	WLD
12-15-57	REVISION TO ROOF TRUSSES	WLD	WLD
12-15-57	REVISION TO ROOF TRUSSES	WLD	WLD



PREPARED BY
W. L. DIXON, INC.
ARCHITECTS
154 EAST 61 ST
NEW YORK 21, N.Y.

BASIC DATA: SEE DRAWING NO. 10, 11, 12, 13, 14, 15, 16, 17, 18, 19, 20, 21, 22, 23, 24, 25, 26, 27, 28, 29, 30, 31, 32, 33, 34, 35, 36, 37, 38, 39, 40, 41, 42, 43, 44, 45, 46, 47, 48, 49, 50, 51, 52, 53, 54, 55, 56, 57, 58, 59, 60, 61, 62, 63, 64, 65, 66, 67, 68, 69, 70, 71, 72, 73, 74, 75, 76, 77, 78, 79, 80, 81, 82, 83, 84, 85, 86, 87, 88, 89, 90, 91, 92, 93, 94, 95, 96, 97, 98, 99, 100

13018

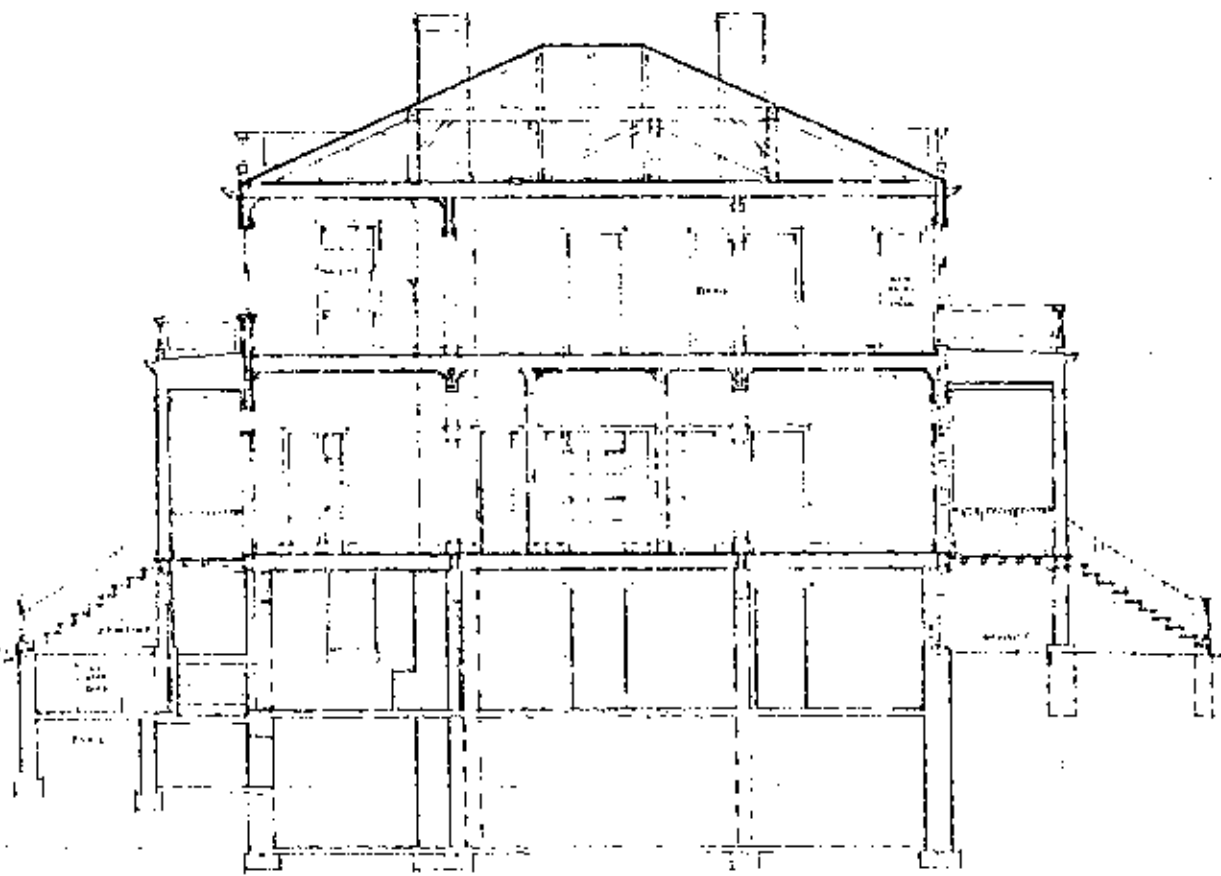

LONGITUDINAL SECTION THROUGH CENTER OF HOUSE

SECTION LOOKING NORTH

SCALE 1/8" = 1'-0"



WALTER BERKELEY
ARCHITECT
434 EAST 61 ST
NEW YORK 21, N.Y.

APPROVED _____

DESCRIPTION OF SECTION	DATE	SCALE
UNITED STATES DEPARTMENT OF THE INTERIOR BUREAU OF RECLAMATION		
PROJECT NO.		
SECTION NO.		
DATE		
BY		
CHECKED		
APPROVED		

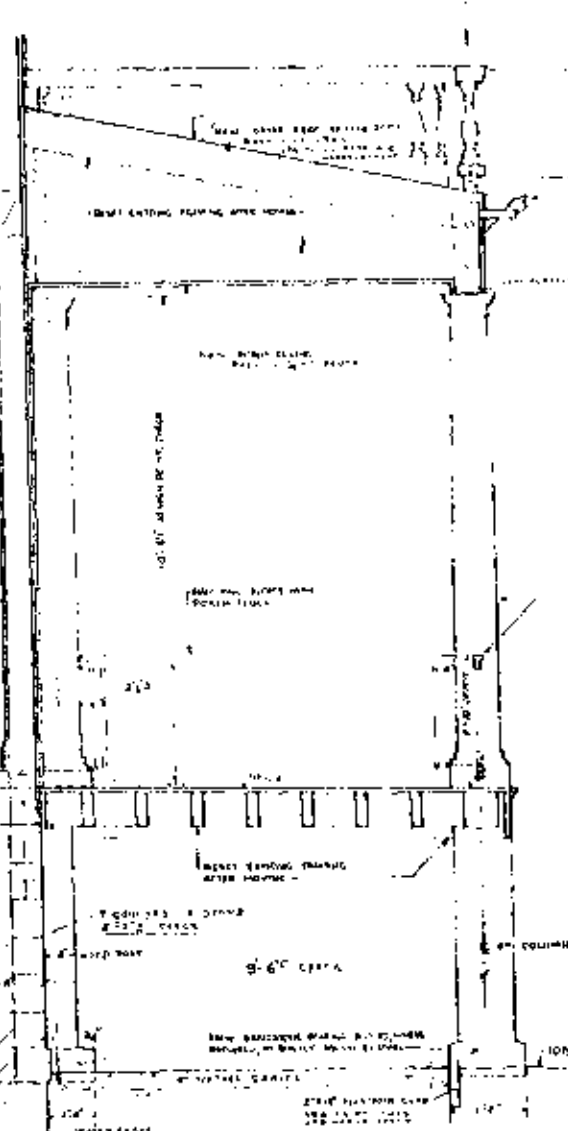
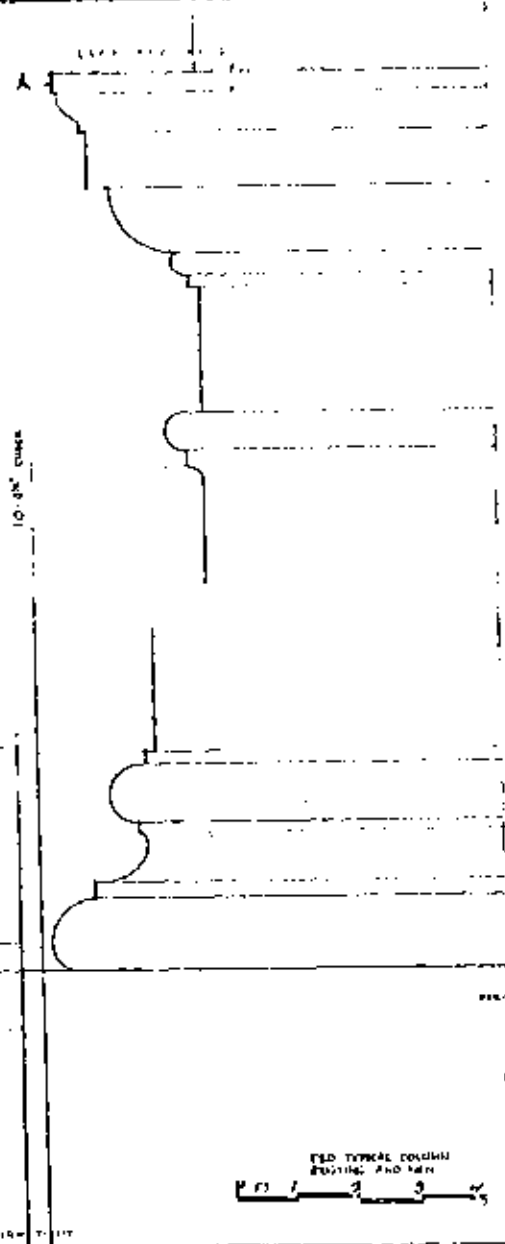

**N. AND S. PORCHES
TYPICAL COLUMN F.S.
HANDRAIL F.S.**

DESCRIPTION OF WORK

UNIVERSITY OF THE DISTRICT OF COLUMBIA
DEPARTMENT OF THE INTERIOR
NATIONAL PARK SERVICE
WASHINGTON, D. C.

APPROVED

REVISION P. BEHN
ARCHITECT
111 EAST 61ST
NEW YORK 21, N.Y.

DATE: 1964

158-38

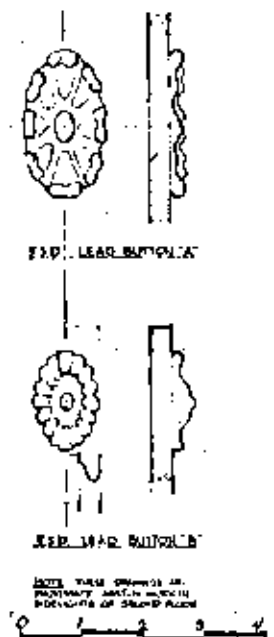
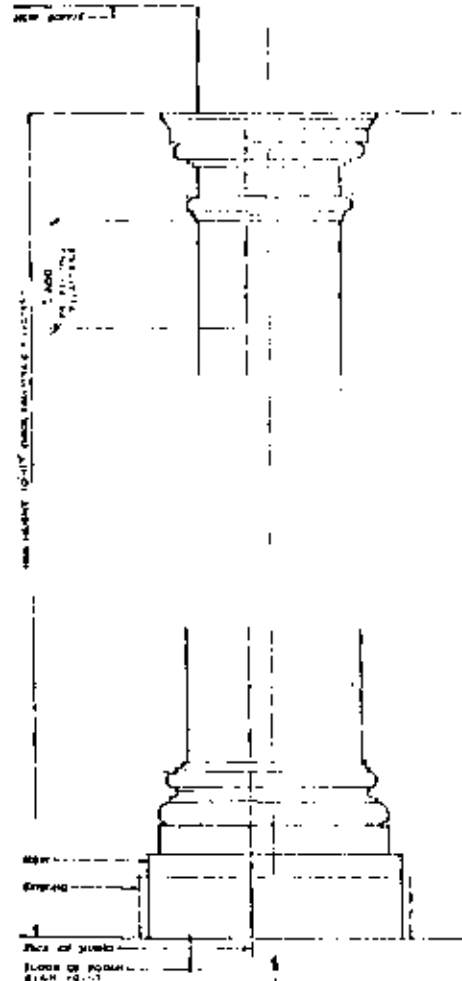

FOR THE LEAF CAPITAL SEE FIG. 2. DETAILS WITH LEAF CAPITAL SHALL BE SETTING ANGLE AND SURFACE OF SPANISH STONE.

SEE THESE DRAWINGS FOR PARTIAL SECTION WHICH INDICATES OF STAIR PLANS

EXISTING, PLASTERED, EXTENDED AND NEW CAPITALS
SCALE 3/4" = 1'-0"

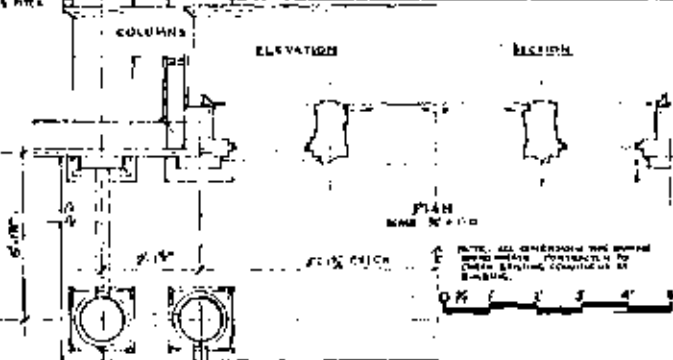
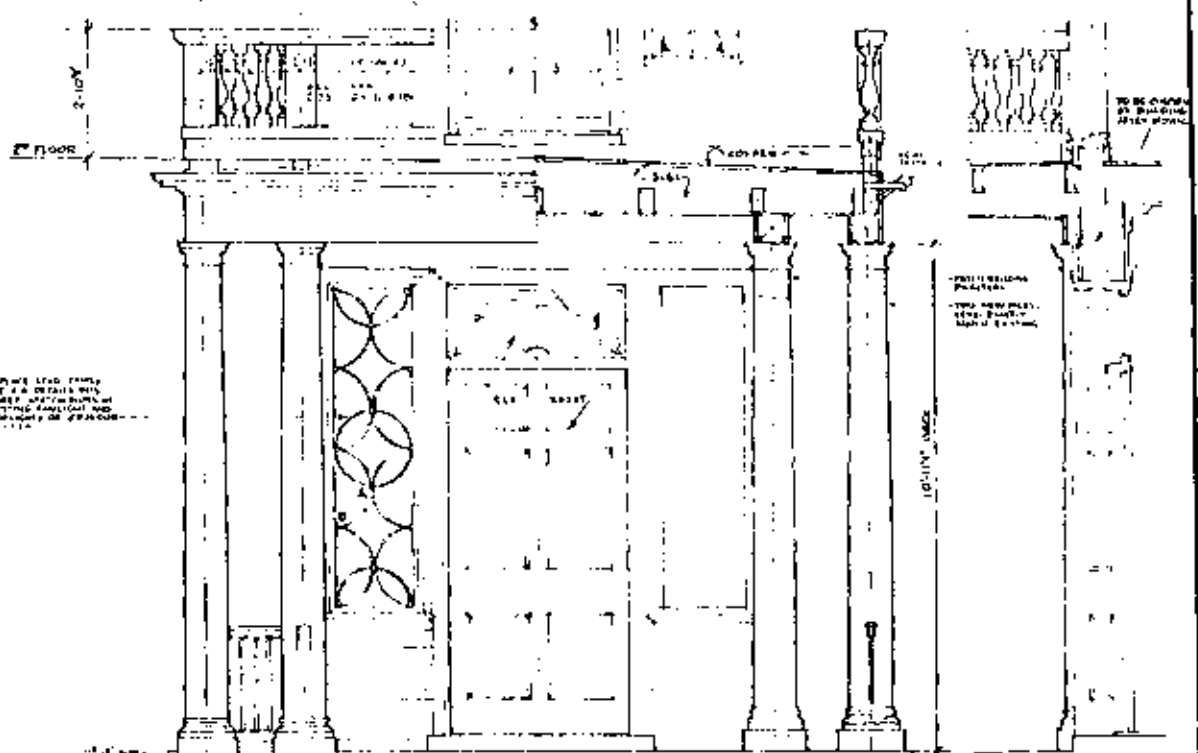

NOTE: ALL DIMENSIONS THE WORK SHALL BE MADE ACCORDING TO THE ORIGINAL DRAWINGS AND SHALL BE MADE ACCORDING TO THE ORIGINAL DRAWINGS.

FRONT ENTRANCE AND STOOP
PILASTERS, CAMES

REVISION	DESCRIPTION OF REVISION
1	PREPARED BY NEW YORK ARCHITECTURE
2	DESIGNED BY NEW YORK ARCHITECTURE
3	APPROVED BY NEW YORK ARCHITECTURE
4	APPROVED BY NEW YORK ARCHITECTURE
5	APPROVED BY NEW YORK ARCHITECTURE
6	APPROVED BY NEW YORK ARCHITECTURE
7	APPROVED BY NEW YORK ARCHITECTURE
8	APPROVED BY NEW YORK ARCHITECTURE
9	APPROVED BY NEW YORK ARCHITECTURE
10	APPROVED BY NEW YORK ARCHITECTURE





NEWCOMB P. DEWITT
ARCHITECT
154 EAST 41 ST
NEW YORK 17 N.Y.

APPROVED BY
APPROVED BY

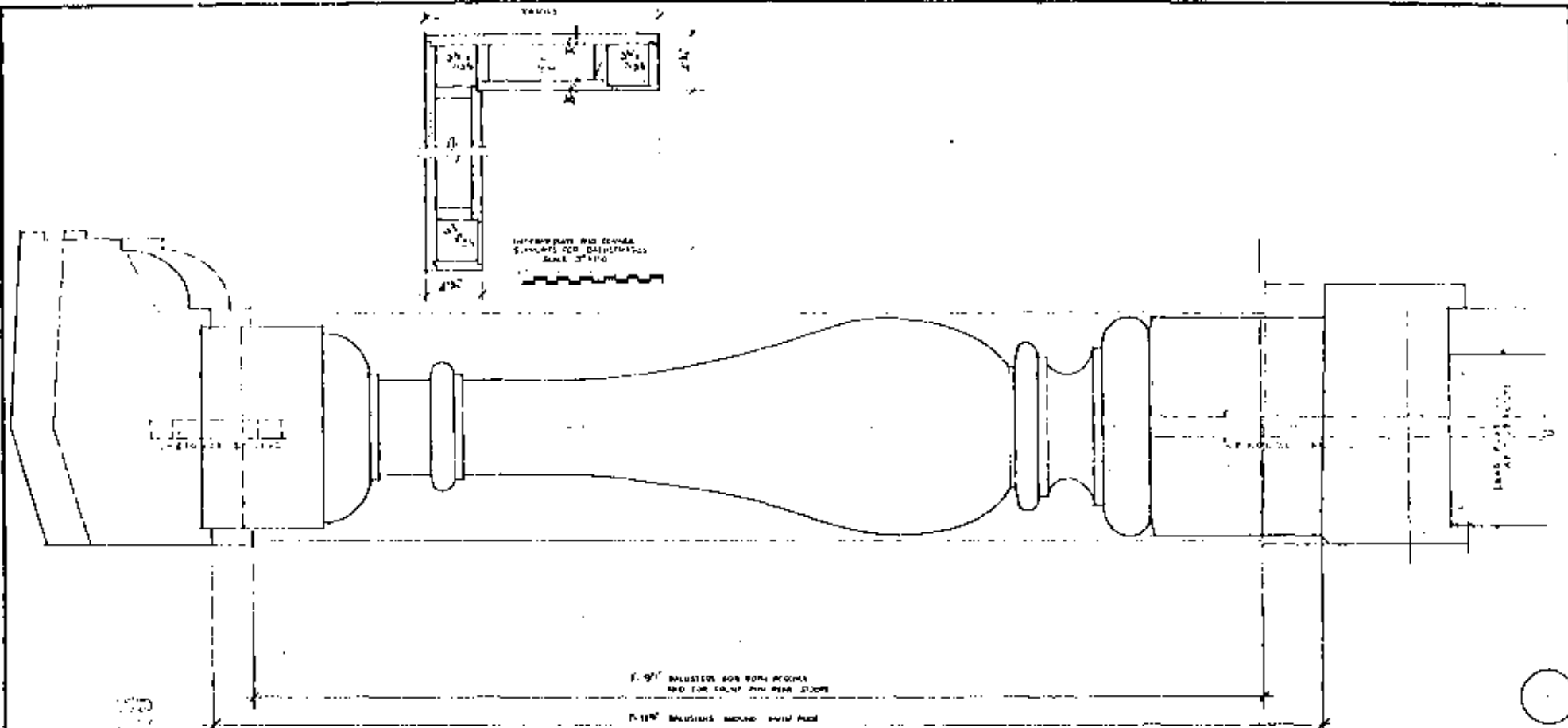
PREPARED BY NEW YORK ARCHITECTURE
DESIGNED BY NEW YORK ARCHITECTURE
APPROVED BY NEW YORK ARCHITECTURE
APPROVED BY NEW YORK ARCHITECTURE
APPROVED BY NEW YORK ARCHITECTURE
APPROVED BY NEW YORK ARCHITECTURE
APPROVED BY NEW YORK ARCHITECTURE
APPROVED BY NEW YORK ARCHITECTURE
APPROVED BY NEW YORK ARCHITECTURE
APPROVED BY NEW YORK ARCHITECTURE
APPROVED BY NEW YORK ARCHITECTURE



E.S.D OF BALUSTRADE

PREPARED BY E.S. DEWITT	APPROVED  E.S. DEWITT
DESIGNED BY M.P. REYER	
CHECKED BY  M.P. REYER	DRAWN BY  M.P. REYER
DATE 1894	PROJECT BALUSTRADE

NEWTON P. DEWITT ARCHT
 15 EAST 41 ST
 NEW YORK

SCALE 1/8" = 1'-0"



NEWTON P. DEWITT
 ARCHT
 15 EAST 41 ST
 NEW YORK, N.Y.

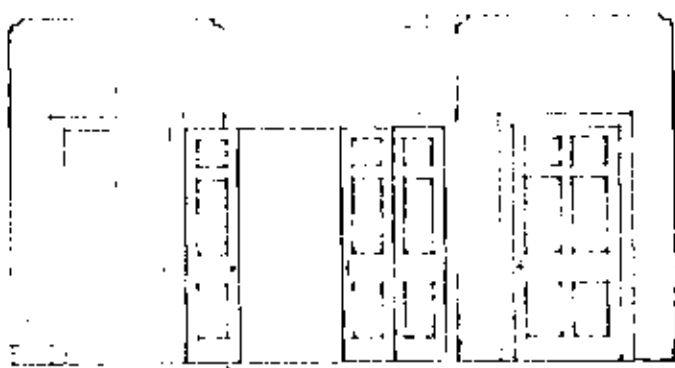

DOOR WITH TRANSOM
 FOLDING DOWN IN OPEN POSITION
 ALL PANELS REVERSED FOR OPEN ONLY
 SHOULD GO TO BATHY KITCHEN, ENTRY

DOORS BETWEEN OCCASION BATHS
 REAR BATH

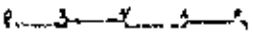

FAMILY DINING ROOM DINING ROOM

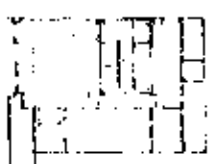

NORTH ELEVATION



KITCHEN ELEVATION
 LOOKING WEST



KITCHEN ELEVATION
 LOOKING EAST

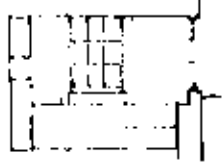

SOUTH ELEVATION

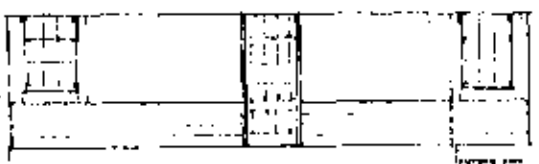

WEST ELEVATION

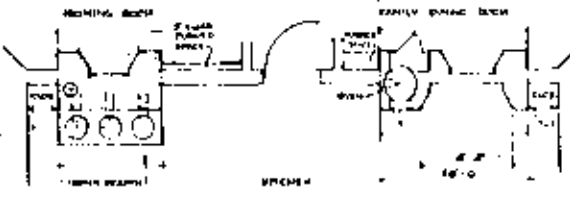

PLAN
 SCALE 3/8" = 1'-0"

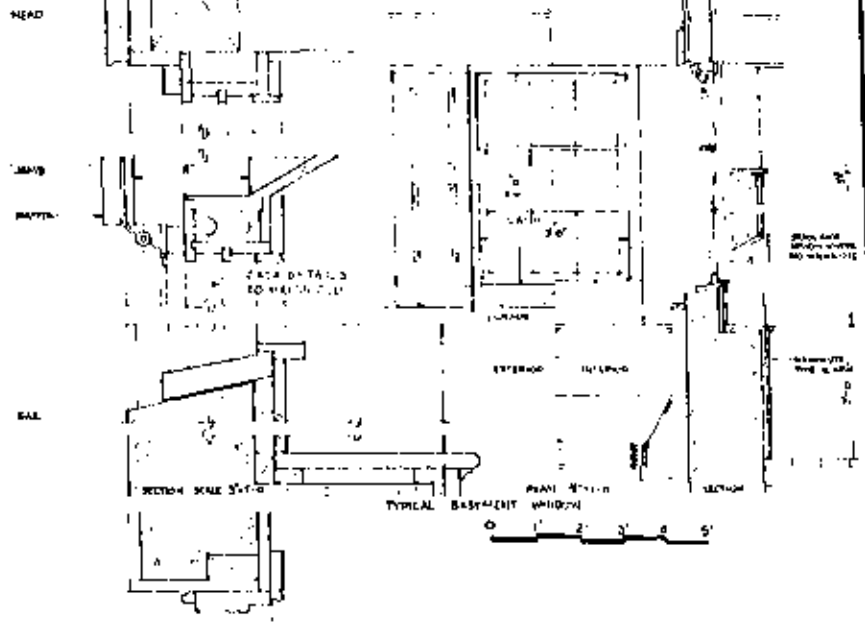

TYPICAL BASEMENT INTERIOR
 DOOR FRAME
 SCALE 3/8" = 1'-0"

TYPICAL BASEMENT
 WINDOW
 SCALE 3/8" = 1'-0"

BASEMENT DETAILS
 IMPROVED DOORS 1ST FLOOR

NEWTON P. BROWN
 ARCHITECT
 15 EAST 115TH
 NEW YORK 21, N.Y.

NO.	DATE	DESCRIPTION OF REVISION	BY	APPROVED
1	10/15/38	REVISED		
2	10/15/38	REVISED		
3	10/15/38	REVISED		
4	10/15/38	REVISED		
5	10/15/38	REVISED		
6	10/15/38	REVISED		
7	10/15/38	REVISED		
8	10/15/38	REVISED		
9	10/15/38	REVISED		
10	10/15/38	REVISED		

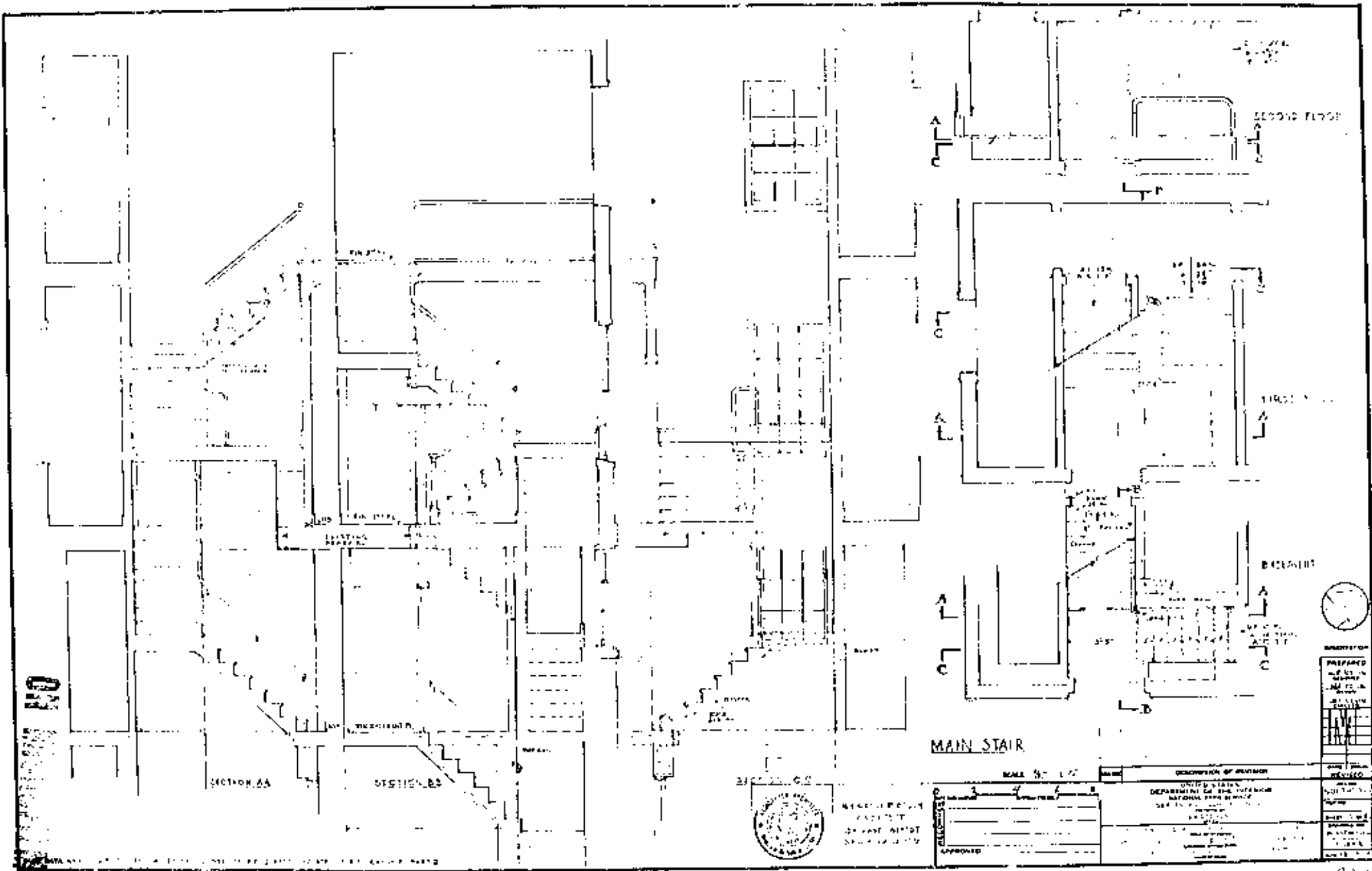

NO

SECTION AA

SECTION BB

MAIN STAIR

SECOND FLOOR

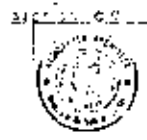

RESEARCH PROJECT
 PROJECT NO. 1000
 OF THE NATIONAL
 PARK SERVICE

DATE: 9-1-57

APPROVED: _____

DESCRIPTION OF DRAWING

UNITED STATES
 DEPARTMENT OF THE INTERIOR
 NATIONAL PARK SERVICE



NO.	DATE	REVISION

20 of 38

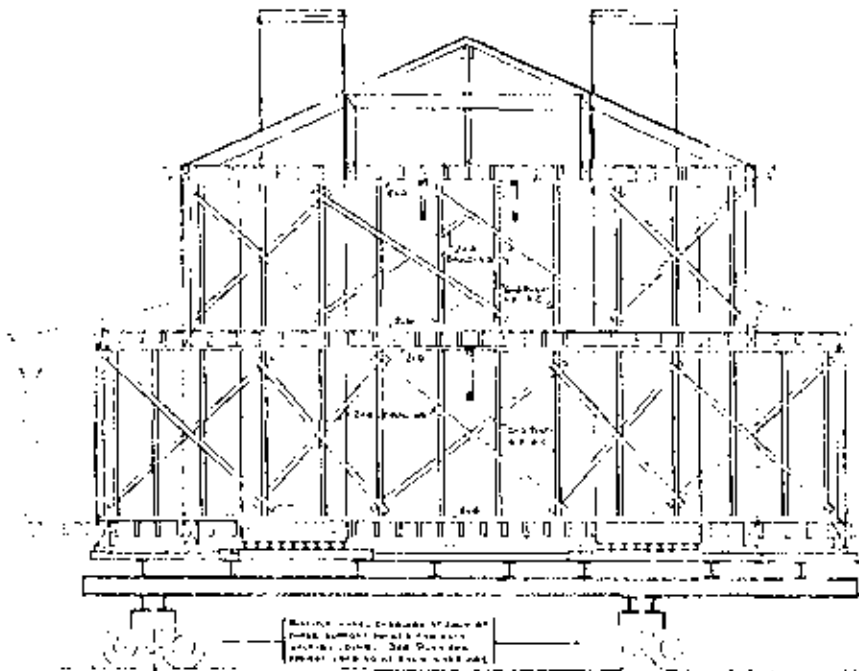

SECTION A-A

MOVING OPERATION LONGITUDINAL SECTION

NO.	DATE	REVISION
1		
2		
3		
4		
5		
6		
7		
8		
9		
10		



REGISTERED	PROFESSIONAL ENGINEER
EXPIRES	
ISSUED	
REVISED	
SCALE	



MATTHEW HULL
 STRUCTURAL ENGINEER
 100 E. 42ND ST.
 NEW YORK 17, N.Y.

APPROVED	
DATE	

UNITED STATES
 DEPARTMENT OF THE INTERIOR
 BUREAU OF LAND MANAGEMENT
 1015 N. 10TH ST.
 DENVER, COLORADO 80202

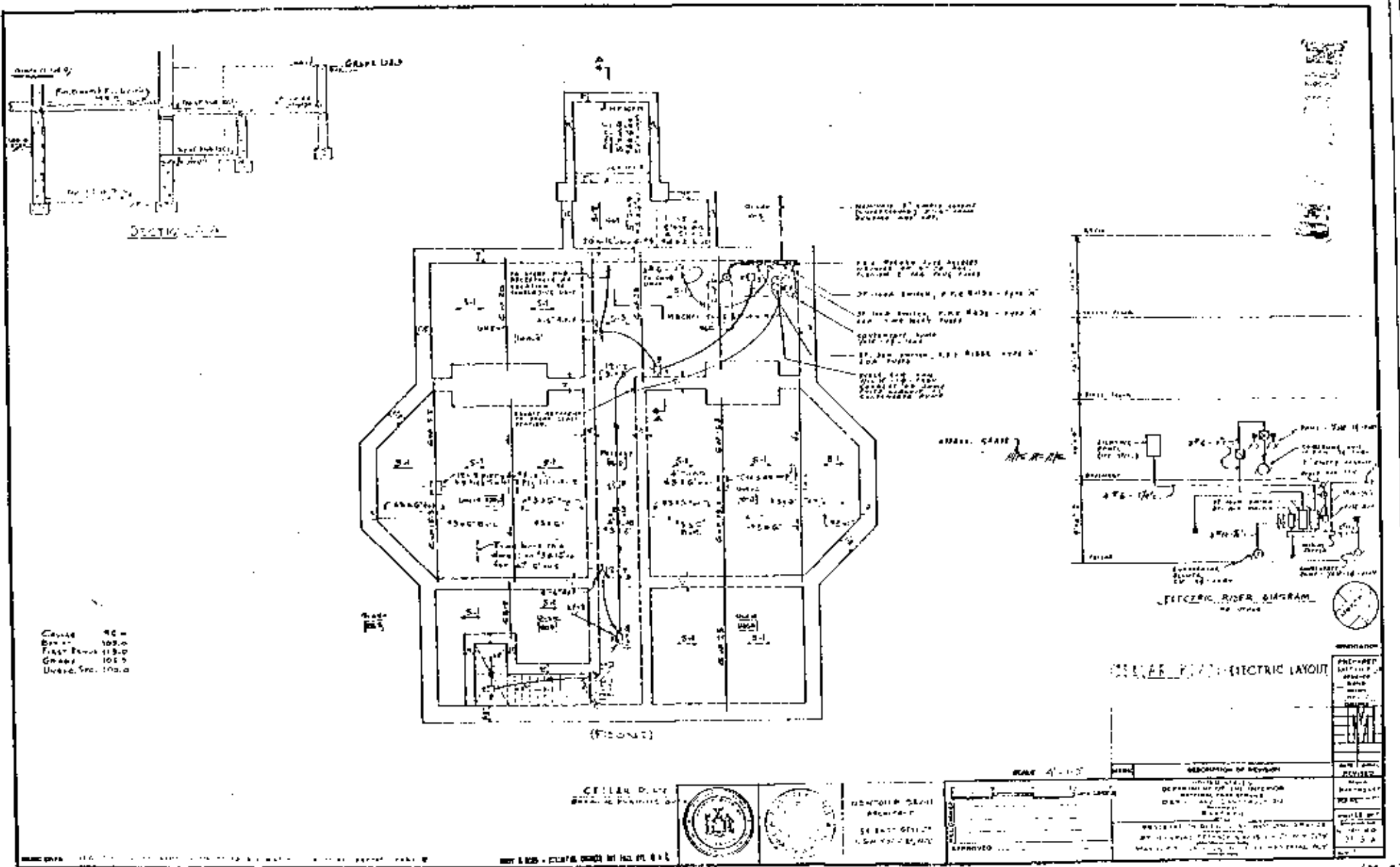

Ceiling 90 m
 Floor 105.0
 First Floor 110.0
 Ground 105.0
 Utility 110.0

CEILING PLAN
 1/4" = 1'-0"



DEPARTMENT OF WATER RESOURCES
 54 EAST STREET
 SACRAMENTO, CALIF.

REVISIONS		DESCRIPTION OF REVISION		DATE	BY

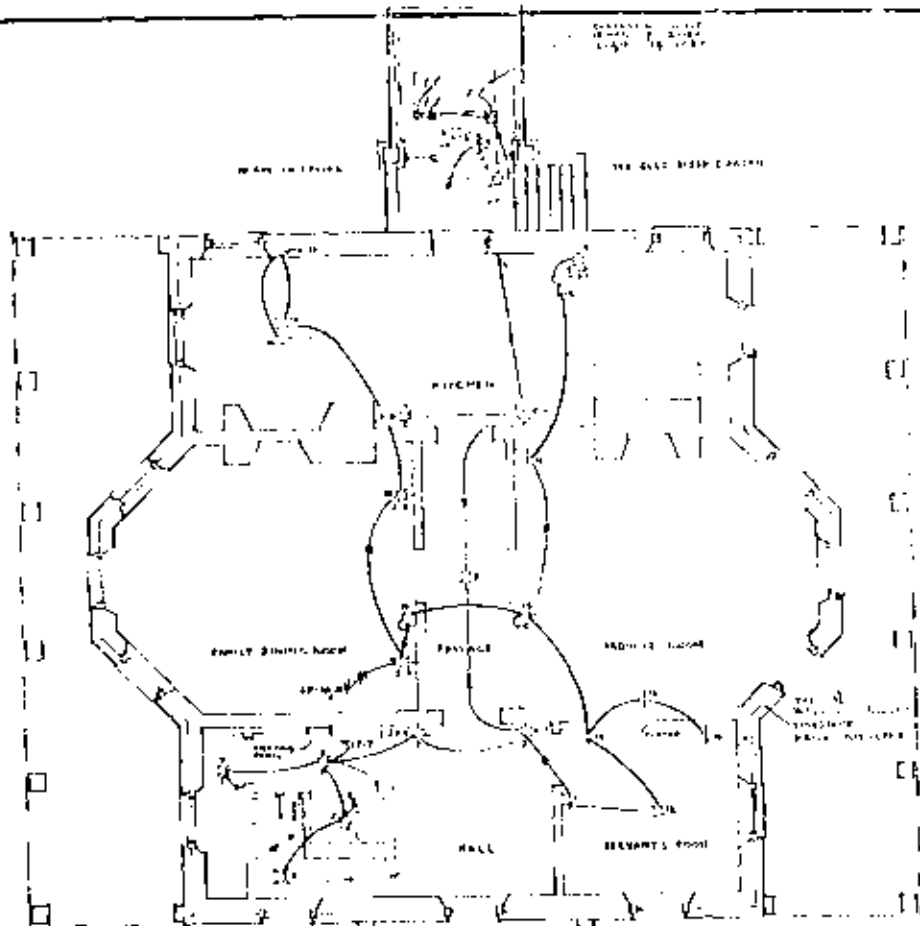

- LEGEND**
- 100 - SWITCHES, DIMMER AND DIMMER
 - 101 - SWITCHES, DIMMER AND DIMMER
 - 102 - SWITCHES, DIMMER AND DIMMER
 - 103 - SWITCHES, DIMMER AND DIMMER
 - 104 - SWITCHES, DIMMER AND DIMMER
 - 105 - SWITCHES, DIMMER AND DIMMER
 - 106 - SWITCHES, DIMMER AND DIMMER
 - 107 - SWITCHES, DIMMER AND DIMMER
 - 108 - SWITCHES, DIMMER AND DIMMER
 - 109 - SWITCHES, DIMMER AND DIMMER
 - 110 - SWITCHES, DIMMER AND DIMMER
 - 111 - SWITCHES, DIMMER AND DIMMER
 - 112 - SWITCHES, DIMMER AND DIMMER
 - 113 - SWITCHES, DIMMER AND DIMMER
 - 114 - SWITCHES, DIMMER AND DIMMER
 - 115 - SWITCHES, DIMMER AND DIMMER
 - 116 - SWITCHES, DIMMER AND DIMMER
 - 117 - SWITCHES, DIMMER AND DIMMER
 - 118 - SWITCHES, DIMMER AND DIMMER
 - 119 - SWITCHES, DIMMER AND DIMMER
 - 120 - SWITCHES, DIMMER AND DIMMER

NOTE: ALL ELECTRICAL WORK IS TO BE DONE IN ACCORDANCE WITH THE NATIONAL ELECTRICAL CODE AND ALL LOCAL ORDINANCES. THE CONTRACTOR SHALL BE RESPONSIBLE FOR OBTAINING ALL NECESSARY PERMITS.

**ELECTRICAL LAYOUT
BASEMENT FLOOR PLAN**



NEWTON & DEVIN
ARCHITECTS
124 EAST 41 ST
NEW YORK 17, N.Y.

DATE: 1-10-50

SCALE: 1/8" = 1'-0"

APPROVED: _____

DEPARTMENT OF THE INTERIOR GEORGE W. BRADY CHIEF OF BUREAU OF REVENUE WASHINGTON, D. C.	RECEIVED JAN 10 1950 DIVISION OF REVENUE WASHINGTON, D. C.
--	---

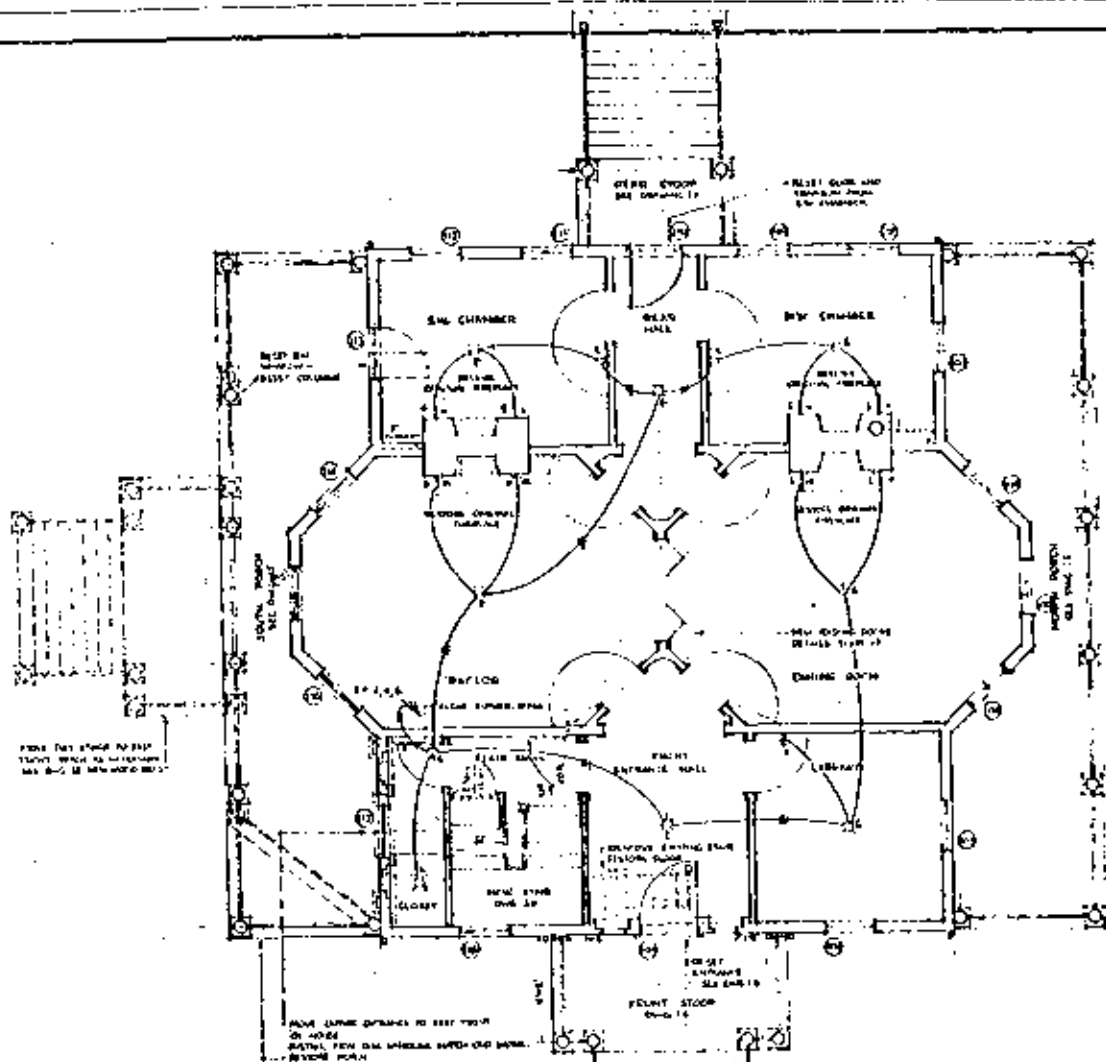

FROM THE STAGE TO THE
THEATRE WHICH IS LOCATED
SEE PLAN ON THE NEXT PAGE

FROM CORNER OF REAR
STAIR TO THEATRE WHICH IS
LOCATED ON THE NEXT
PAGE

NOTE: ALL ELECTRICAL SYMBOL LOCATIONS
AND TERMINALS - REFER TO SEPARATE
LOCATING AT CONTRACTING OFFICE



NO. 100-100000-100

- KEY
- DASHED LINE TO BE REMOVED
 - DASHED LINE TO BE REMOVED
 - DASHED LINE TO BE REMOVED

ELECTRIC LAYOUT
FIRST FLOOR PLAN



RECEIVED
ARCHITECT
DEPT. OF THE INTERIOR
WASHINGTON, D.C.

APPROVED

DATE

NO.	DESCRIPTION OF REVISION	DATE

PREPARED BY	
DESIGNED BY	
CHECKED BY	
DATE	
SCALE	
PROJECT NO.	

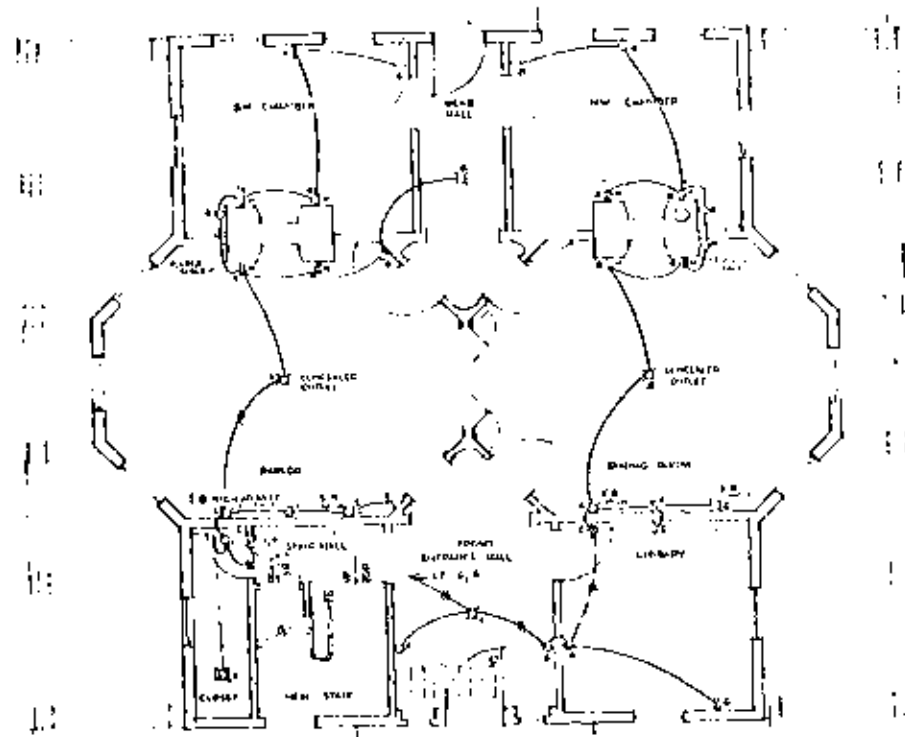

NOTE: ALL ELECTRICAL SYMBOLS, CONDUIT AND TRAYS, SUBJECT TO CHECK LOCATIONS BY CONTRACTOR OFFICE.



ELECTRICAL LAYOUT FIRST FLOOR

NO.	REVISION
1	ISSUED
2	REVISION
3	REVISION
4	REVISION
5	REVISION
6	REVISION
7	REVISION
8	REVISION
9	REVISION
10	REVISION

SCALE	DESCRIPTION OF REVISION
1" = 10'-0"	REVISION 1: ADD ELECTRICAL SYMBOLS AND TRAYS TO EXISTING LAYOUT.
	REVISION 2: CORRECT CONDUIT ROUTING IN CONFERENCE ROOM.
	REVISION 3: ADD ELECTRICAL SYMBOLS IN DINING ROOM.
	REVISION 4: CORRECT TRAY ROUTING IN LIBRARY.
	REVISION 5: ADD ELECTRICAL SYMBOLS IN HALLS.
	REVISION 6: CORRECT CONDUIT ROUTING IN SW CHAMBER.
	REVISION 7: ADD ELECTRICAL SYMBOLS IN NE CHAMBER.
	REVISION 8: CORRECT TRAY ROUTING IN DINING ROOM.
	REVISION 9: ADD ELECTRICAL SYMBOLS IN CONFERENCE ROOM.
	REVISION 10: CORRECT CONDUIT ROUTING IN HALLS.



NEW YORK ENGINEER
 STATE OF NEW YORK
 LICENSE NO. 12345
 JOHN J. JONES

APPROVED

 ELECTRICAL ENGINEER

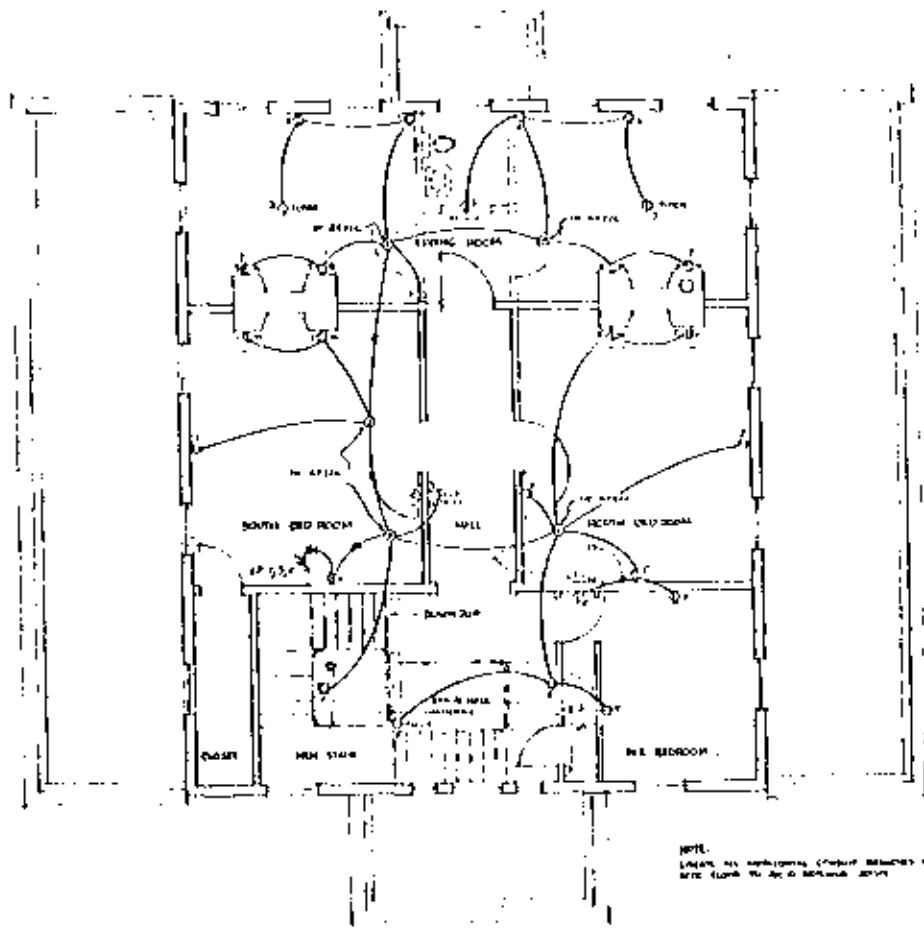

NOTE: ALL ELECTRICAL LIGHT FIXTURES TO BE INSTALLED IN ACCORDANCE WITH THE NATIONAL ELECTRICAL CODE AS AMENDED BY LOCAL ORDINANCES.

NOTE: LOCATE ALL ELECTRICAL SYMBOLS IN ACCORDANCE WITH THE NATIONAL ELECTRICAL CODE AS AMENDED BY LOCAL ORDINANCES.

**ELECTRICAL LAYOUT
SECOND FLOOR PLAN**



ORIENTATION

PREPARED BY	DATE
CHECKED BY	DATE
APPROVED BY	DATE
REVISIONS	
NO.	DESCRIPTION
1	AS SHOWN

NO.	DESCRIPTION OF REVISION



NEWTON D. BEHM
REGISTERED
154 EAST 81 ST
NEW YORK 21, N.Y.

APPROVED	DATE

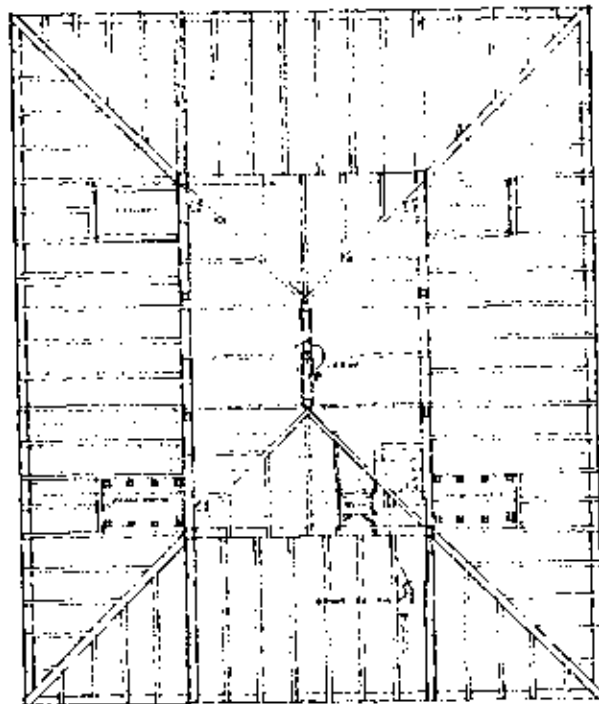

ELECTRIC LAYOUT

FRANK EDWARDS
ELECTRICAL ENGINEER

PREPARED BY DATE DRAWN BY CHECKED BY APPROVED BY
--

SCALE 1/4" = 1'-0"



MEMORANDUM
 ARCHITECT
 151 EAST 64 ST
 NEW YORK 21, N.Y.

APPROVED _____
 DATE _____

UNITED STATES
 DEPARTMENT OF THE INTERIOR
 NATIONAL PARK SERVICE
 WASHINGTON, D. C.

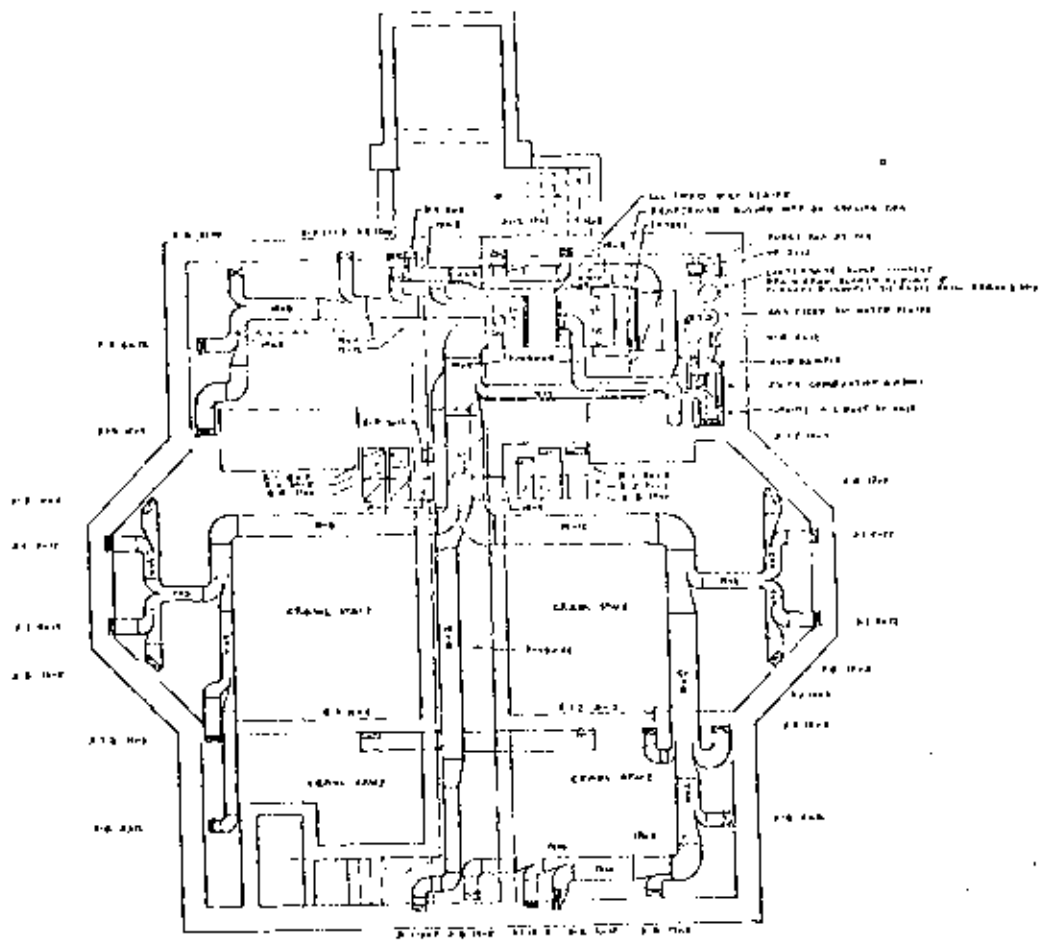

CELLAR PLAN

HEATING, VENTILATING
CELLAR PLAN



NEWTON P. DEVIN
ARCHITECT
100 EAST WASHINGTON
WASHINGTON, D. C.
WALTER H. BOND
CONSULTING ENGINEER
100 EAST WASHINGTON
WASHINGTON, D. C.

APPROVED

UNITED STATES
DEPARTMENT OF THE INTERIOR
NATIONAL FOREST SERVICE
OFFICE OF THE SUPERVISOR
WASHINGTON, D. C.

PROJECT NO.	100
DATE	10/10/34
SCALE	1/4" = 1'-0"
BY	N.P.D.
CHECKED	W.H.B.
DATE	10/10/34
APPROVED	
DATE	10/10/34

ALL DIMENSIONS ARE TO FACE UNLESS OTHERWISE SPECIFIED

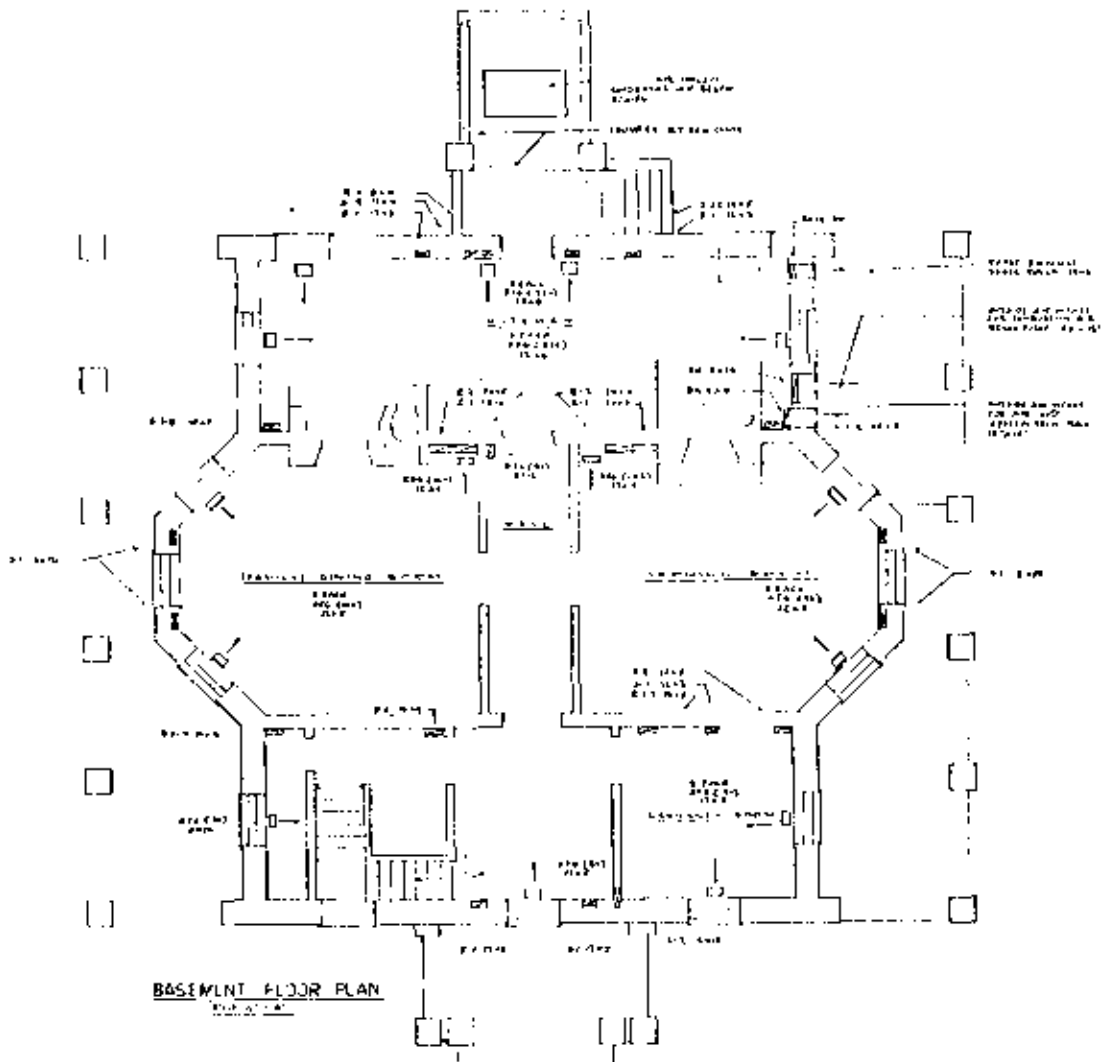

BASEMENT FLOOR PLAN
SCALE: 1/4" = 1'-0"

**HEATING, VENTILATING
 BASEMENT FLOOR PLAN**



NEWTON P. DEVYN
 ARCHITECT
 LICENSE NO. 101
 1000 G ST.
 WASHINGTON, D.C.

MARKS W. BOND
 CONSULTING ENGINEER
 LICENSE NO. 101
 1000 G ST.
 WASHINGTON, D.C.

NO.	DESCRIPTION OF REVISION	DATE	BY	REVISION



PREPARED BY:
 DATE:
 CHECKED BY:
 DATE:
 APPROVED BY:
 DATE:

BASEMENTS ARE TO BE CONSTRUCTED WITH REINFORCED CONCRETE STRUCTURE MEMBERS SHALL BE

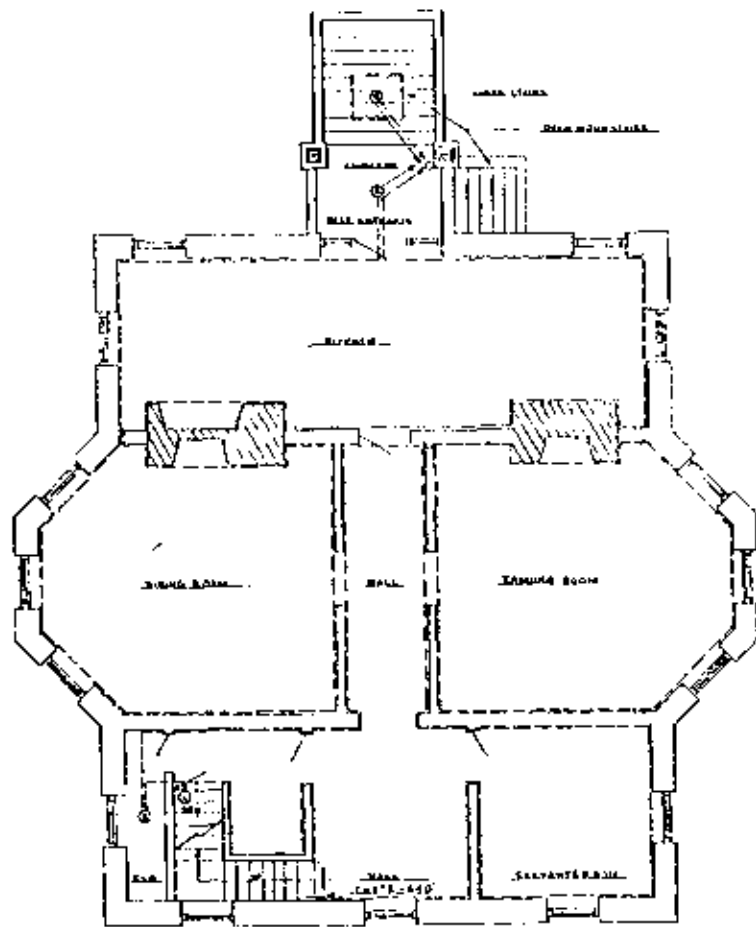

**FIRE DETECTION SYSTEM
BASEMENT PLAN**



JEFFERSON P. DEAN, AIA
 ARCHITECT
 175 EAST 42ND ST
 NEW YORK 17, N.Y.

SCALE 1/4" = 1'-0"

APPROVED _____

DESCRIPTION OF PROJECT

UNITED STATES
 DEPARTMENT OF THE INTERIOR
 NATIONAL PARK SERVICE
 NATIONAL MONUMENT

BY ARCHITECT _____ DATE _____

NO.	REVISION
1	ISSUED
2	REVISED
3	REVISED
4	REVISED
5	REVISED
6	REVISED
7	REVISED
8	REVISED
9	REVISED
10	REVISED

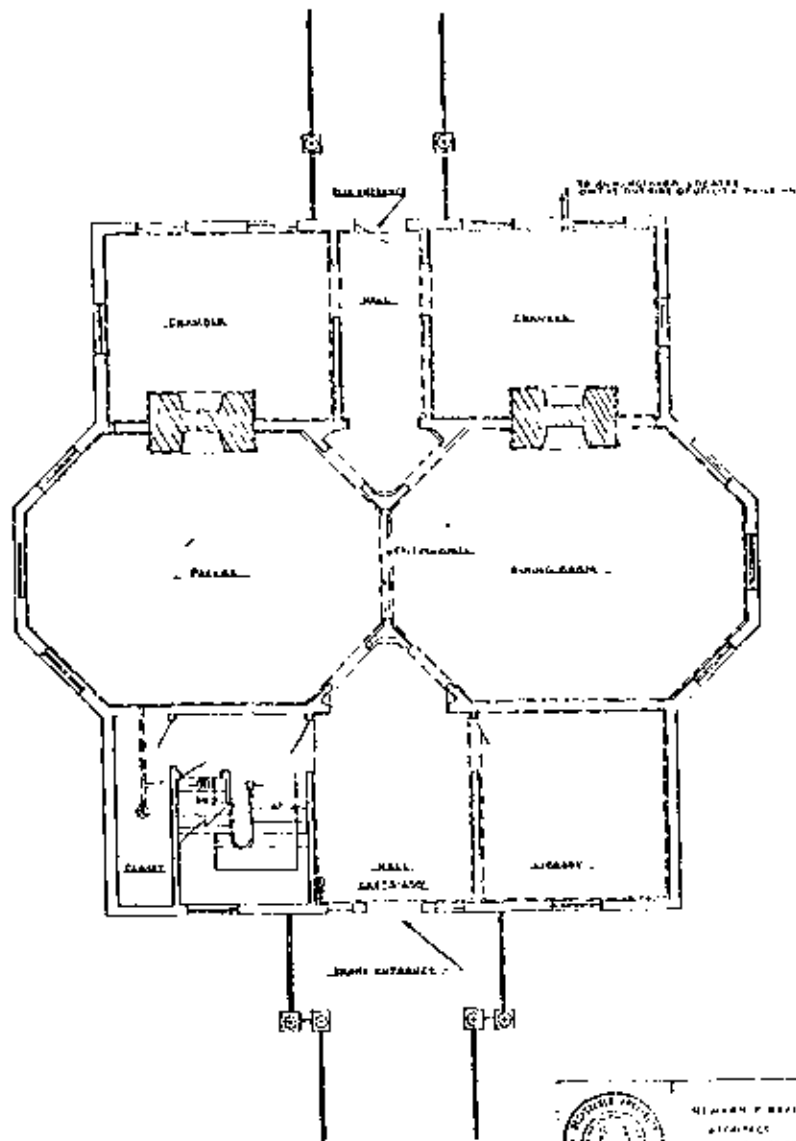

FIRE DETECTION SYSTEM
FIRST FLOOR PLAN



DEPARTMENT OF THE INTERIOR
NATIONAL GAME WARDEN
WASHINGTON, D. C.

DATE	DESCRIPTION OF WORK
APPROVED	

DATE	DESCRIPTION OF WORK
APPROVED	

PREPARED BY	DATE
CHECKED BY	DATE
APPROVED BY	DATE

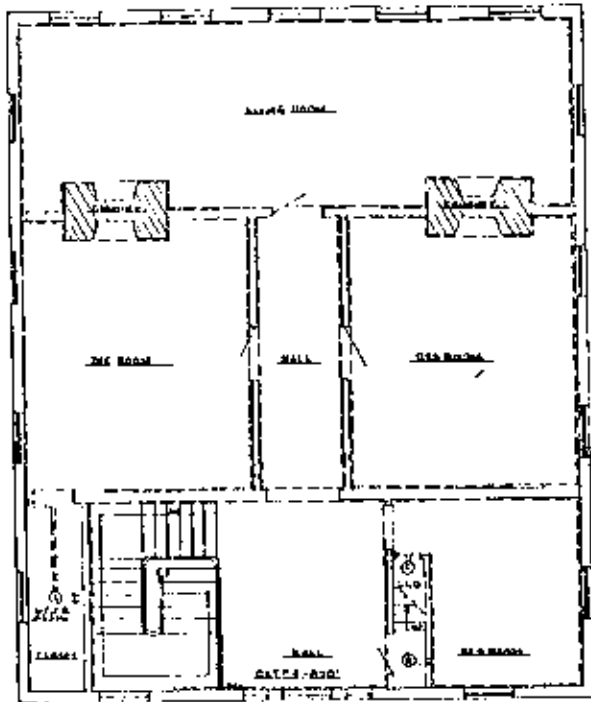

SECOND FLOOR

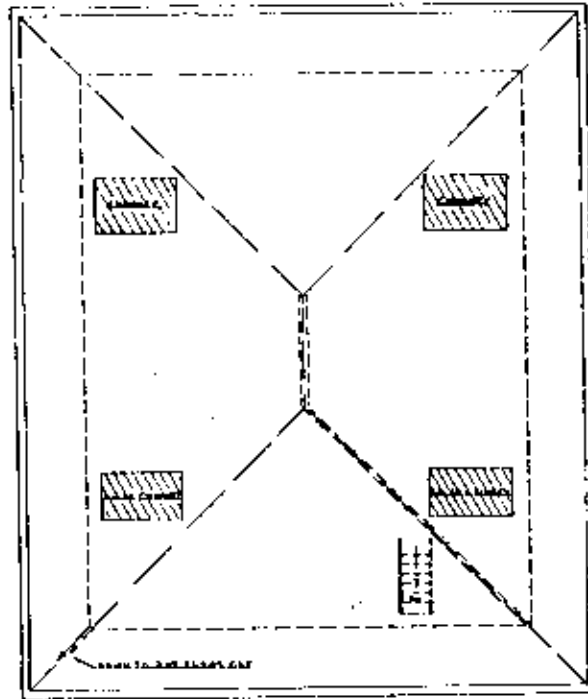

ATTIC

FIRE DETECTION SYSTEM
SECOND FLOOR & ATTIC



NO.	DATE	REVISION
1		
2		
3		
4		
5		
6		
7		
8		
9		
10		



HEATON P. BEHN
REGISTERED
FIRE ALARM CONTRACTOR
NEW YORK, N.Y.

SCALE 1/4" = 1'-0"

APPROVED _____

OFFICE OF THE
DEPARTMENT OF THE INTERIOR
BUREAU OF FIRE PREVENTION
WASHINGTON, D.C.

EXPLANATION: DRAWN BY: JAMES H. STONE
CHECKED BY: J. H. STONE
APPROVED BY: J. H. STONE

Appendix K

Restoration of Hamilton Grange

Phase I

1978-1979

"As Constructed" Drawings by the Denver Service Center, NPS

These drawings record most of the work done during the Phase I stabilization campaign of 1978-1979. Additional information can be gleaned from documentation photographs taken by Wilbur G. Elting during the course of the work. These are available at the North Atlantic Historic Preservation Center in Boston, Massachusetts.

RESTORATION OF HAMILTON GRANGE

PHASE ONE

AS CONSTRUCTED DRAWINGS

CONTRACT NO. CX-1600-B-9021
PROJECT NO. 1015-784

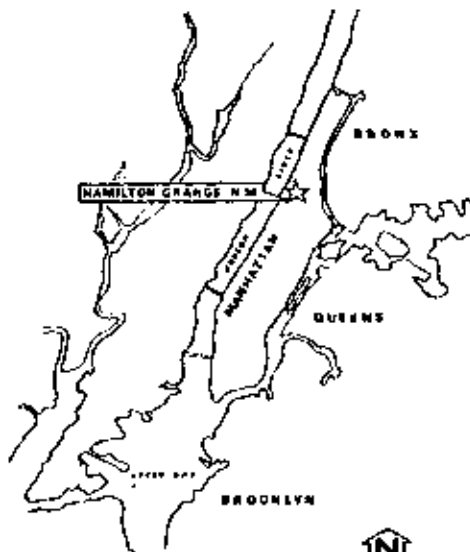

VICINITY MAP



c1870



1978

CONTENTS

1. TITLE SHEET
2. SUBBASEMENT PLAN
3. BASEMENT PLAN
4. FIRST FLOOR PLAN
5. SECOND FLOOR PLAN
6. ROOF AND ROOF FRAMING PLAN
7. WEST ELEVATION
8. SOUTH ELEVATION
9. EAST ELEVATION
10. NORTH ELEVATION
11. SECTION A-A
12. SECTION B-B
13. PORCH DETAILS
14. PORCH DETAILS
15. COLUMN DETAILS
16. MAIN ROOF DETAILS
17. PORCH ROOF DETAILS
18. WINDOWS, BASEMENT AND FIRST FLOOR BAY
19. WINDOWS, FIRST AND SECOND FLOOR
20. SCHEDULES, WINDOWS, DOORS, AND SHUTTERS
21. NEWEL POST AND CEILING BOARD DETAILS
22. PORCH ROOF FRAMING PLAN
23. ROOF FRAMING PLAN AND SECTIONS
24. EAST PORCH FLOOR FRAMING PLAN
25. MAIN ROOF GUTTER ASSEMBLY
26. COLUMN DETAILS
27. EAST PORCH (REVISION)
28. NEW MILLWORK PROFILES
29. PORCH FRAMING PLANS
30. PORCH FRAMING PLANS
31. MISCELLANEOUS COLUMN DETAILS
32. MISCELLANEOUS COLUMN DETAILS
33. MISCELLANEOUS DETAILS
34. MISCELLANEOUS DETAILS

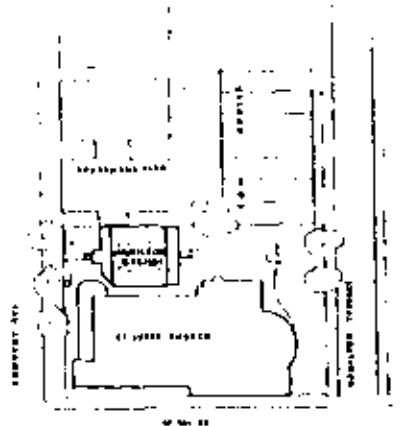

SITE



REDUCED SIZE REPRODUCTION

REPRODUCED <i>[Signature]</i> CONTRACTOR 1234 5th Ave NEW YORK, N.Y. 10001	AS CONSTRUCTED DRAWINGS SMO, C.B.	ARCHITECT [Signature] 1234 5th Ave NEW YORK, N.Y. 10001	AD CONSTRUCTED DRAWING	PREPARED BY GULAM WALKER EMPLOYED BY NATIONAL PARK SERVICE 12 JULY 78	TITLE SHEET OF RESTORATION OF HAMILTON GRANGE PHASE ONE HAMILTON GRANGE MANHATTAN SITE	DRAWING NO. 518 61002A SHEET 1 OF 34
			UNITED STATES DEPARTMENT OF THE INTERIOR NATIONAL PARK SERVICE DENVER SERVICE CENTER	DATE OF ISSUE 12 JULY 78	SCALE AS SHOWN	

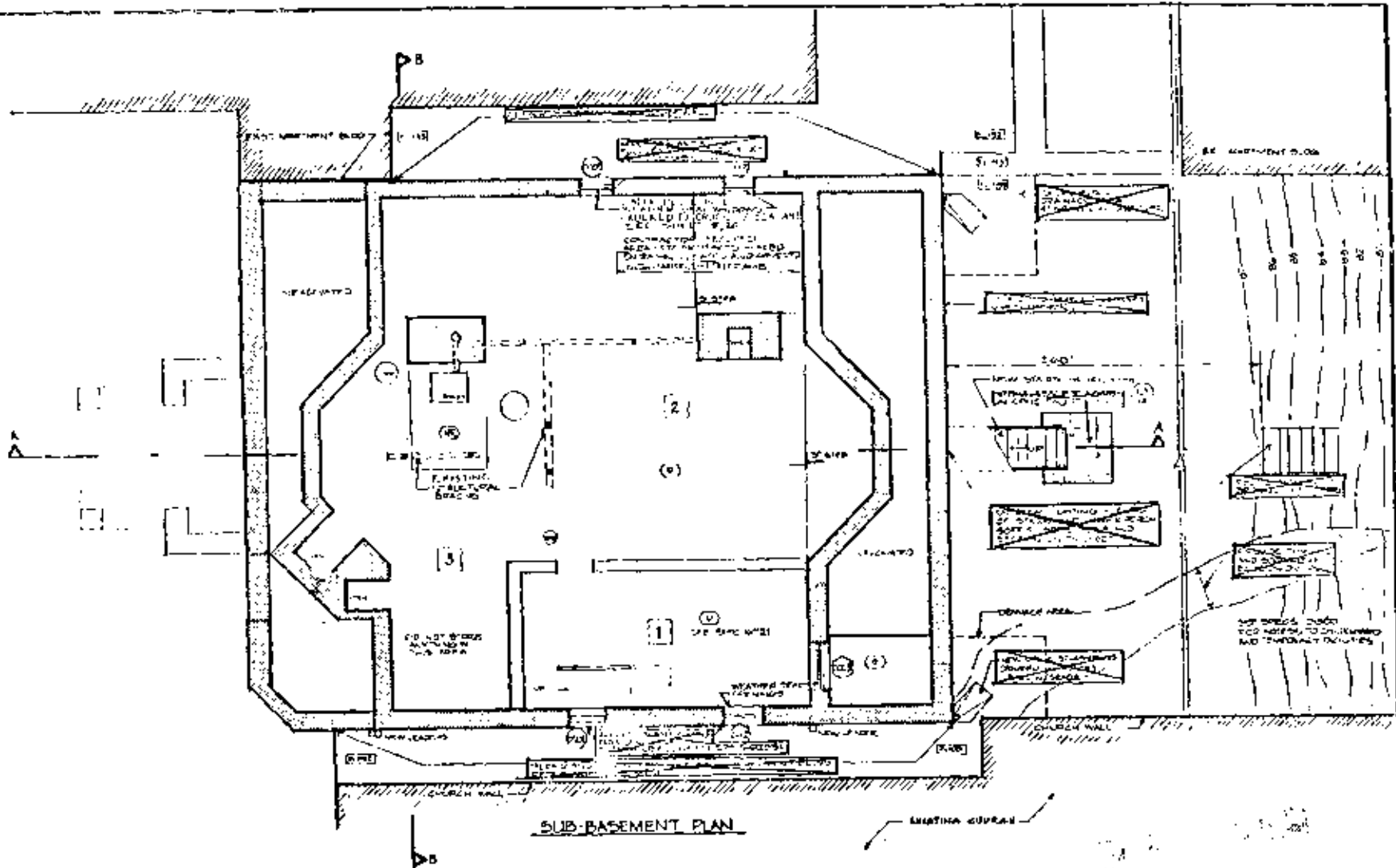

NOTE:
THE DETECTIONS DERIVED FROM CONTRACT

PHASE ZONE I
SUB-BASEMENT PLAN

01224
SCALE 1/4" = 1'-0"

REVISION	DATE	BY	CHKD
1	11/28/84
2
3
4
5

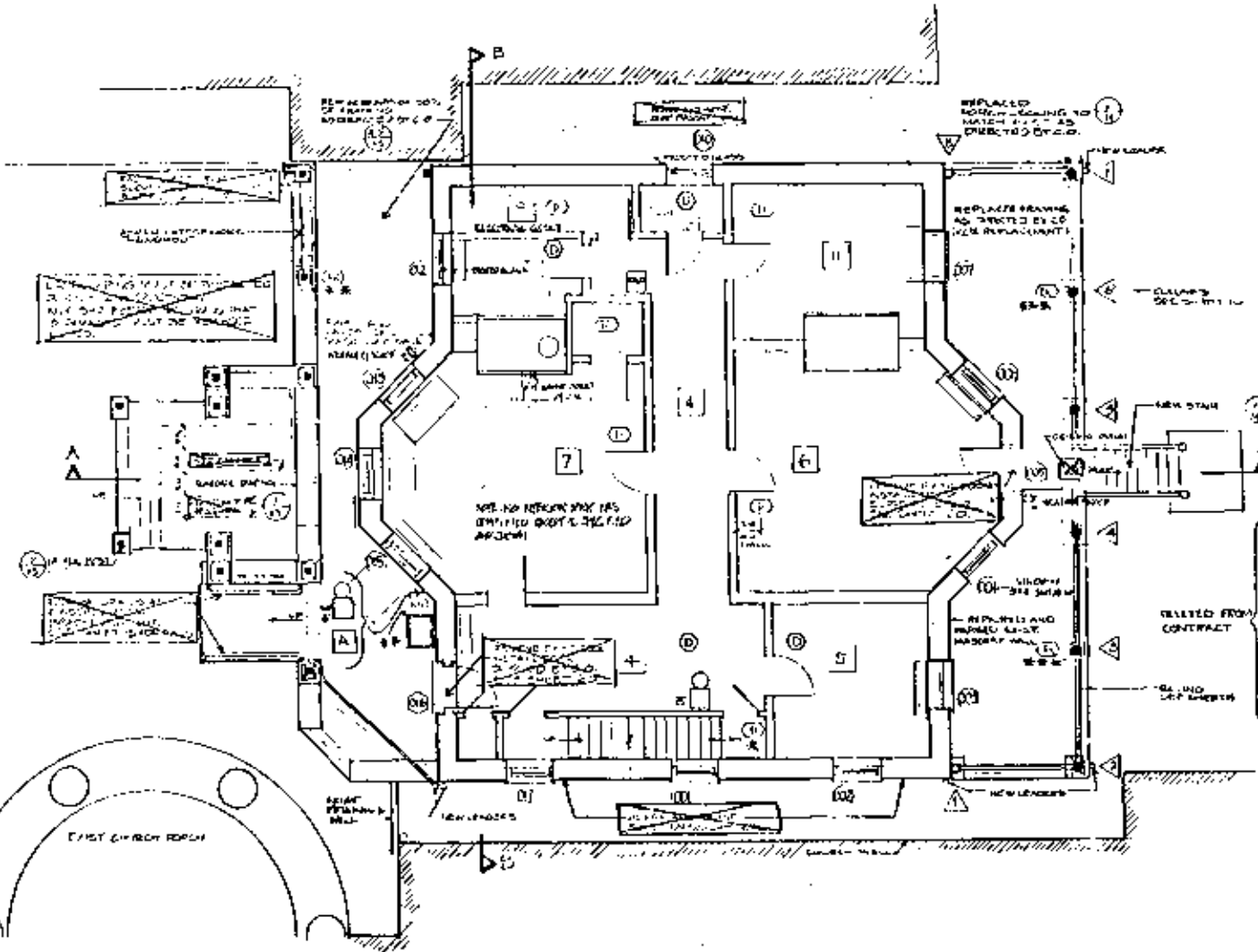

PLUMBING NOTE:
 CHECKED EXIST. RADIATORS AND FIXTURES FOR ANY LEAKS AND FOR PROPER DRAINAGE. MADE SUGGESTED REPAIRS REPORTED CONDITIONS TO C.O.

- ELECTRICAL LEGEND**
- 71- IONIZATION DETECTOR
 - 72- RATED TEMP/RATE OF RISE DETECTOR
 - 73- CEILING OUTLET/ OUTDOOR LIGHT
 - 74- SWITCH
 - 75- WEATHERPROOF GUMMER OUTLET: W/COVER W/COVER W/ GROUND WIRING
 - 76- RANGE OUTLET 220V
 - 1- BELL, 10 INCH
 - 2- BELL, 8 INCH
 - 3- GEL, 8 INCH, WEATHER PROOF
 - 4- SENSITIVE ANNUNCIATOR, SEVEN(7) ZONES
 - 5- MAIN FIRE ALARM PANEL, BATTERIES, DIALER
- * THIS DETECTOR CONNECTED TO FIRE ZONE 1
 ** UNDERSIDE OF FRONT PORCH IS FIRE ZONE 4
 *** REAR PORCH IS FIRE ZONE 7

NOTES:
 FIRE DETECTORS DELETED FROM CONTRACT

FIRE ZONE 2 ***
BASEMENT PLAN



APPROVED	DATE	PROJECT NO.	SHEET NO.
BY	4-28-68	458	1
FOR			
BY			
FOR			
BY			
FOR			

100-100-100
 100-100-100
 100-100-100

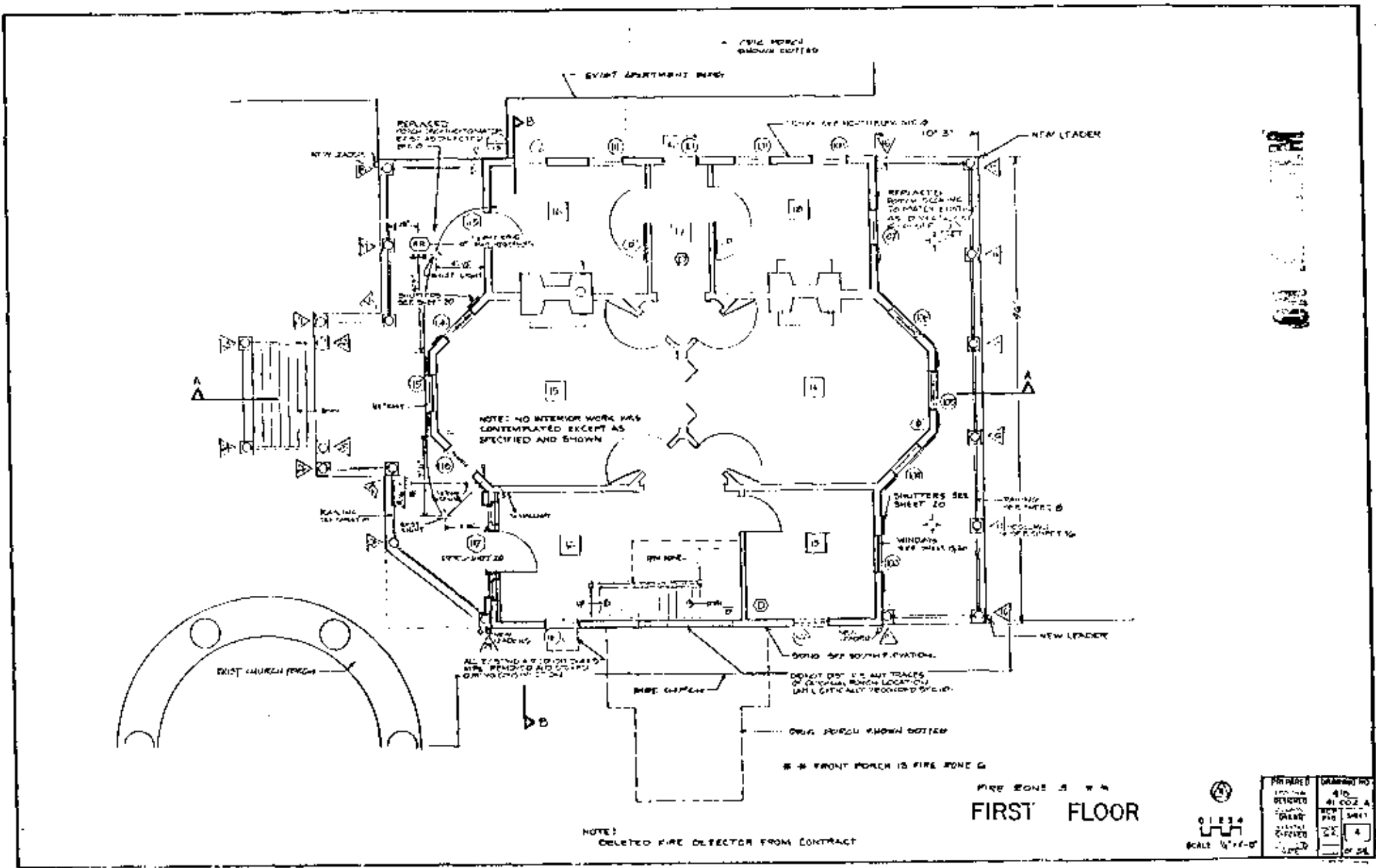

EXIST PORCH SHOWN DOTTED

EXIST APARTMENT WING

RELEASED
ROOF REINFORCEMENT
BY 2" ADDITIONAL
R.F.C.

10' 3"

NEW LEADER

REFLECTED
ROOFING TO MATCH EXISTING
AS TO MATERIAL
AND COLOR

NOTE: NO INTERIOR WORK HAS
CONTEMPLATED EXCEPT AS
SPECIFIED AND SHOWN

SHUTTERS SEE
SHEET 20

TRAINING
PLATFORM B

WINDAYS
SEE SHEET 20

NEW LEADER

ALL EXISTING & REMOVED
WALLS REMOVED AND OUTLINE
GIVEN ON SHEET 20

DO NOT SEE ROOM LOCATION

DO NOT DIST. UP ANY TRACES
OF ORIGINAL ROOM LOCATION
UNLESS SPECIFICALLY REQUESTED

EXIST PORCH SHOWN DOTTED

EXIST FRONT PORCH IS FIRE ZONE G

FIRE ZONE S & A
FIRST FLOOR

NOTE:
DELETED FIRE DETECTOR FROM CONTRACT

SCALE 1/8" = 1'-0"

NO. DRAWN	410
NO. CHECKED	41 COZ A
NO. DESIGNED	41
NO. APPROVED	4
NO. REVISIONS	0

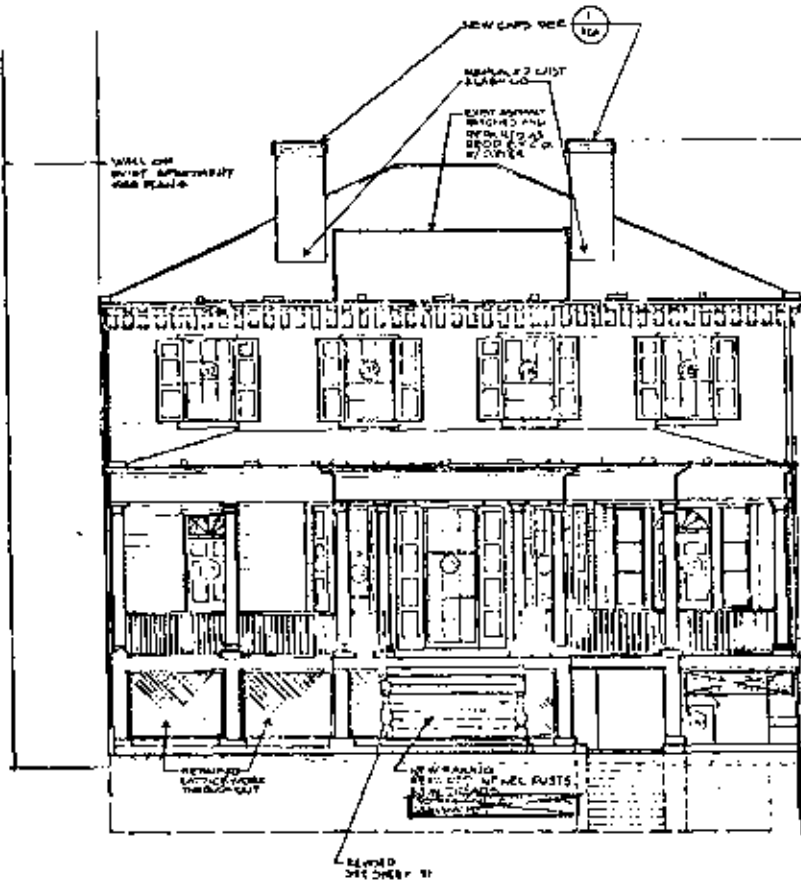

ROOF
REPAIRED BRICK CHIMNEYS
FASCIA CHIMNEYS REPLACED METAL WITH T&G

BEAM ROOF AS DIMICED BY E.O.

REPAIRED AND INSTALLED T&G
FOR ALL THE CHIMNEYS
SEE SHEET 11

DORMER ASSEMBLY
REMOVED GUTTER AND CORNICE
REMOVED UP WALL TO MATCH EXIST HISTORIC FABRIC
REPAIRED SEE SHEET 11
NEW LEADERS SEE SHEETS 8, 9, 10

EXIST ROOF
REMOVED EXIST ROOF, VERIFIED ORIGINAL ROOF SYSTEM
INSPECTED FRAME, RE-ALL DIMENSIONED MEMBERS
INSTALLED NEW DORMER ROOF SEE SHEET 11
NEW GUTTER ASSEMBLY SEE SHEET 11

EXTERIOR
REMOVED EXIST SIDING
REPAIRED AS NECESSARY
REINSTALLED

REPAIRED TRIMMER AS
DIMICED BY E.O.

REMOVED RAILING - EXIST
REPAIRED AS NECESSARY
REINSTALLED

BASEMENT WALL
REPAIRED AND FINISHED
EXIST FINISH

WALL OF
EXIST CHIMNEY

SIDING NOTES:

REMOVED, REPAIRED AND REPLACED SIDING
AS DIMICED BY CONTRACTOR OFFICE
SEE SPECS. 01097

WINDOW, DOOR, SHUTTER NOTES:

FOR TREATMENT OF WINDOWS, DOORS, AND SHUTTERS SEE
SHEET 11, 12, 13, 14, 15, 16, 17, 18, 19, 20, 21, 22, 23, 24

WEST ELEVATION

SCALE 1/4" = 1'-0"

PREPARED BY ARCHITECT DATE DRAWN BY DATE	DESIGNED BY DATE CHECKED BY DATE APPROVED BY DATE	SHEET NO. 7 OF 24
--	--	-------------------------



WEST PORCH
 REMOVED EXIST. DECK, RAILING AND
 REINSTALLED FRAME AS SHOWN
 REINSTALLED NEW 1" x 12" ROOF
 SEE SHEET 17.
 REPAIRED DECK, CEILING
 WEST STAIR
 REMOVED EXIST. COLUMNS
 REPAIRED AS NECESSARY
 REINSTALLED, RESEALED
 WITH NEW
 REPAIRED FINISHING AS
 DIRECTED BY C.O.
 REMOVED RAILING
 REPLACED WITH NEW
 MATCHING HISTORIC

REPLACED EXIST
 FINISHING

STRIPS, REPAIRED, REPLACED
 GARDENWAYS AS DIRECTED BY C.O.

REMOVED EXIST. ROOF, REINSTALLED HISTORIC
 REPLACED FRAME, FINISHED THROUGH
 INSTALLED NEW 1" x 12" ROOF SEE SHEET 17.
 INSTALL NEW BATT INSULATION PER I.C.

ROOF
 REPOINTED BRICK CHIMNEYS,
 REPLACED FLUES, CHIMNEYS W/ T.C.S.
 REPAIR ROOF AS DIRECTED BY C.O.

EARTH ASSEMBLY
 REMOVED GUTTER AND GORNICE,
 REINSTALLED OR MATCHED TO MATCH EXIST HISTORIC
 REPAIRED SEE SHEET 16.

ROOF ROOF
 REMOVED EXIST. ROOF, REINSTALLED HISTORIC
 REPLACED FRAME, FINISHED THROUGH
 INSTALLED NEW 1" x 12" ROOF SEE SHEET 17.
 INSTALL NEW BATT INSULATION PER I.C.

NEW WATER ASSEMBLY - SEE SHEET 17.

EAST PORCH FIRST FLOOR
 REMOVED EXIST. CEILING
 REPAIRED AS NECESSARY
 REINSTALLED

REMOVED, REPAIRED AND RESEALED
 AND CEILING ROOF AS DIRECTED BY C.O.
 REPAIRED FINISHING AS DIRECTED BY C.O.

REMOVED RAILING, REINSTALLED WITH NEW
 REPAIRED AS NECESSARY
 REINSTALLED

EAST PORCH BASEMENT
 REPAIRED EXIST. COLUMNS
 REINSTALLED AND REPLACED W/ NEW
 REMOVED, REPAIRED EXIST. DECK AND
 CEILING ROOF AS DIRECTED BY C.O.
 REPAIRED, REPLACED FINISHING AS DIRECTED BY C.O.

REMOVED RAILING, REINSTALLED WITH NEW
 REPAIRED AS NECESSARY
 REINSTALLED

EAST STAIR
 REMOVED EXIST. STAIR,
 FABRICATED AND INSTALLED
 NEW STAIR SEE SHEET 14

INSTALL NEW BROWNSTONE
 LEADERS AT GUTTERS

CONCRETE

REMOVED, REPAIRED AND
 RESEALED
 RESEALED OPENING WITH
 CONC. BLOCK AND SEAL

NEW LEADERS FOR
 SEE SHEETS 8 AND 16

SOUTH ELEVATION

SCALE 1/8" = 1'-0"

PREPARED BY DATE	CHECKED DATE	DESIGNED DATE	QUANTITY NO. DATE	SHEET NO. DATE



SIDING CONDITION



CRACKING MASONRY

WALL OF 2ND FLOOR



REPAIRED EXTERIOR
DRAINAGE OPEN
W/2 CHIMNEYS

NEW STAIR, HANDS & RAILS
SEE SHEET 17



CORNICE CONDITION

NOTE: SIDING
SEE SHEETS 2 AND 3
FOR TYPICAL EXTERIOR
TREATMENT

WALL OF 2ND
FLOOR

BASEMENT WALL
REPAIRS AND FINISHES
EXIST. MASONRY

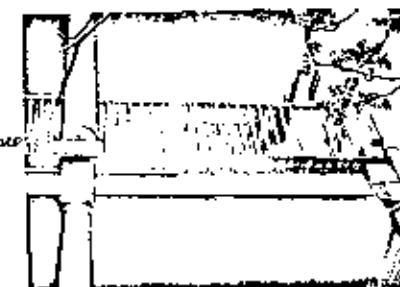

PORCH CONDITION

WALL FINISHING AND
REPAIRS SEE SHEET 20

EAST ELEVATION

SCALE 1/4" = 1'-0"

PREPARED BY J. H. COOPER	DRAWING NO. 416-4024
CHECKED BY J. H. COOPER	SHEET 11
TOTAL SHEETS 34	OF 34



NOTE: SEE SHEET 21



NOTE: SEE SHEET 21

REPAIR AND PATCH
BRICK WORK
AS DIRECTED BY C.O.

REVISOR SEE SHEET 21

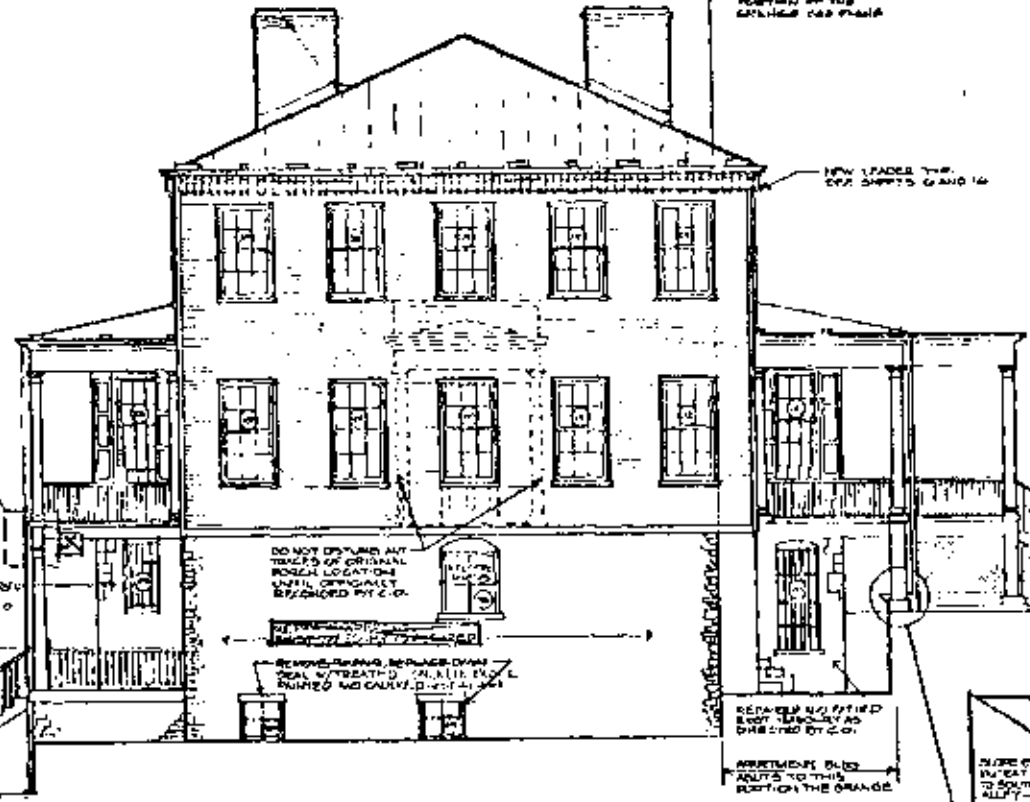

APARTMENT SIGN
ADULTS TO THIS
PORTION OF THE
GRANGE

NEW LEADER TOP
OFF SHEETS G AND 14

NOTE:
FOR NOTES ON EXTERIOR
TREATMENT SEE SHEETS 2 AND 8

SEE STAIRS
OFF SHEET 21
REVISOR SEE SHEET 21

REPAIR AND PATCH
BRICK WORK AS
DIRECTED BY C.O.

APARTMENT SIGN
ADULTS TO THIS
PORTION OF THE GRANGE

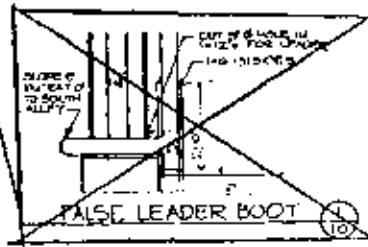

FALSE LEADER BOOT

NORTH ELEVATION

SCALE 1/4" = 1'-0"

PREPARED BY	DATE
DESIGNED BY	4/10/24
CHECKED BY	FOR
APPROVED BY	10
DATE	OF 24

12'-0" CHIMNEY CAP
 10'-2 1/2" FLOORING
 10'-0" ATTIC FLOOR
 17'-0" 2ND FLOOR
 14'-8" 1ST FLOOR
 0'-0" GRADE
 0'-0" 1ST BASEMENT
 0'-0" 2ND BASEMENT

CHIMNEY CAP 12'-0"
 ATTIC FLOOR 10'-0"
 2ND FLOOR 17'-0"
 1ST FLOOR 14'-8"
 GRADE 0'-0"
 1ST BASEMENT 0'-0"
 2ND BASEMENT 0'-0" FINISH

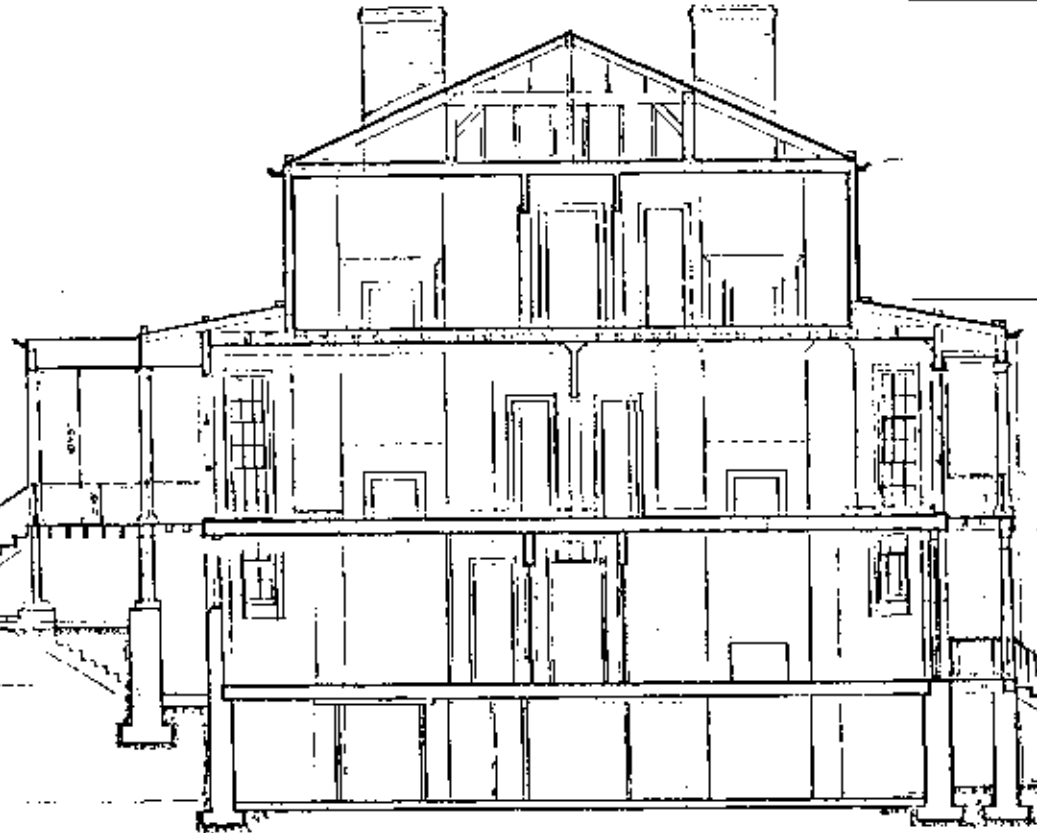

SECTION A-A

 SCALE 1/2" = 1'-0"

PREPARED BY	DATE	DESIGNED BY	DATE
DRAWN BY	11	CHECKED BY	11
APPROVED BY	11	DATE	11

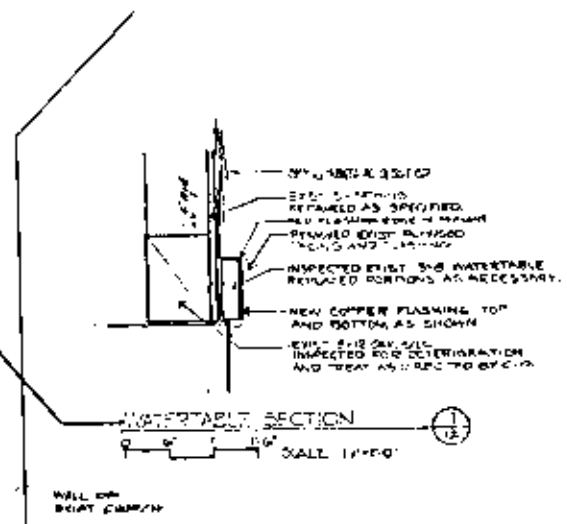
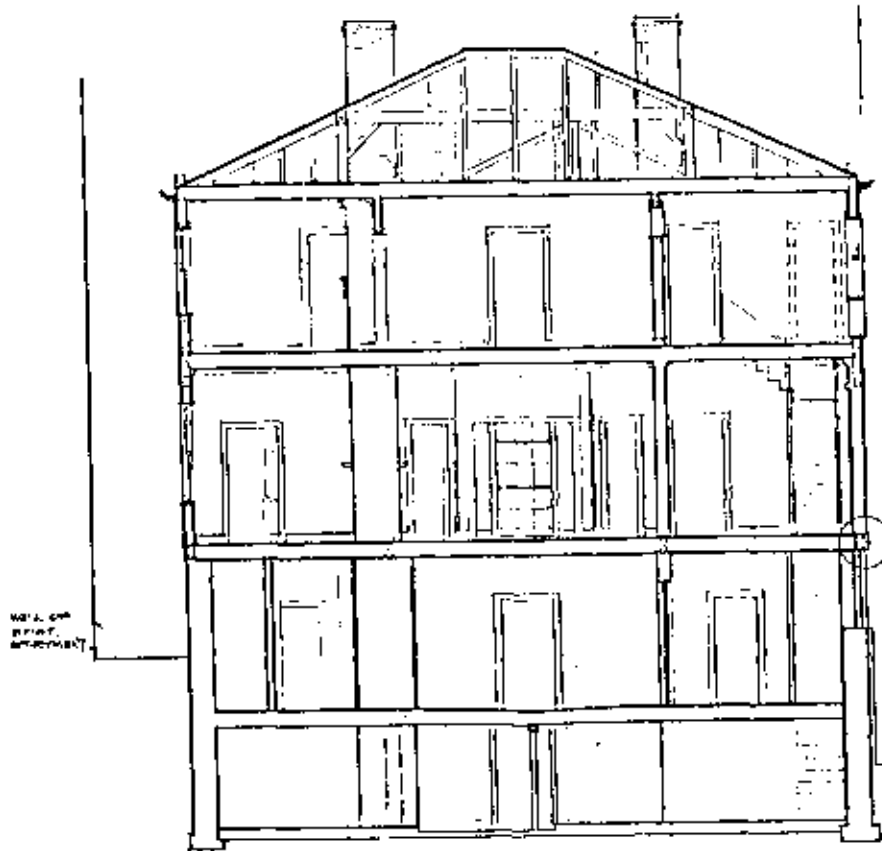

- EXIST. WATER TABLE
- EXIST. FLASHING
- REPAIRED AS SPECIFIED
- NEW FLASHING EDGE OF ROOF
- REMOVED EXIST. FLASHING
- INSULATED AND FINISHED
- INSPECTED EXIST. S/S WATERTABLE
- REPLACED PORTIONS AS NECESSARY
- NEW COPPER FLASHING TOP
- AND BOTTOM AS SHOWN
- EXIST. S/S ON WALL
- INSPECTED FOR DETRIORATION
- AND TREAT AS DIRECTED BY C.O.

WATERTABLE SECTION
 CALL 12:12

WALL ON REAR ELEVATION

WALL ON EXIST. ELEVATION

SECTION B-B

SCALE 1/4" = 1'-0"

PREPARED BY KING DESIGN WALKER DRAFTER CHECKED DATE 11-18-50	DRAWING NO. 512 47002-A 107 SHEET 17 OF 24
---	--

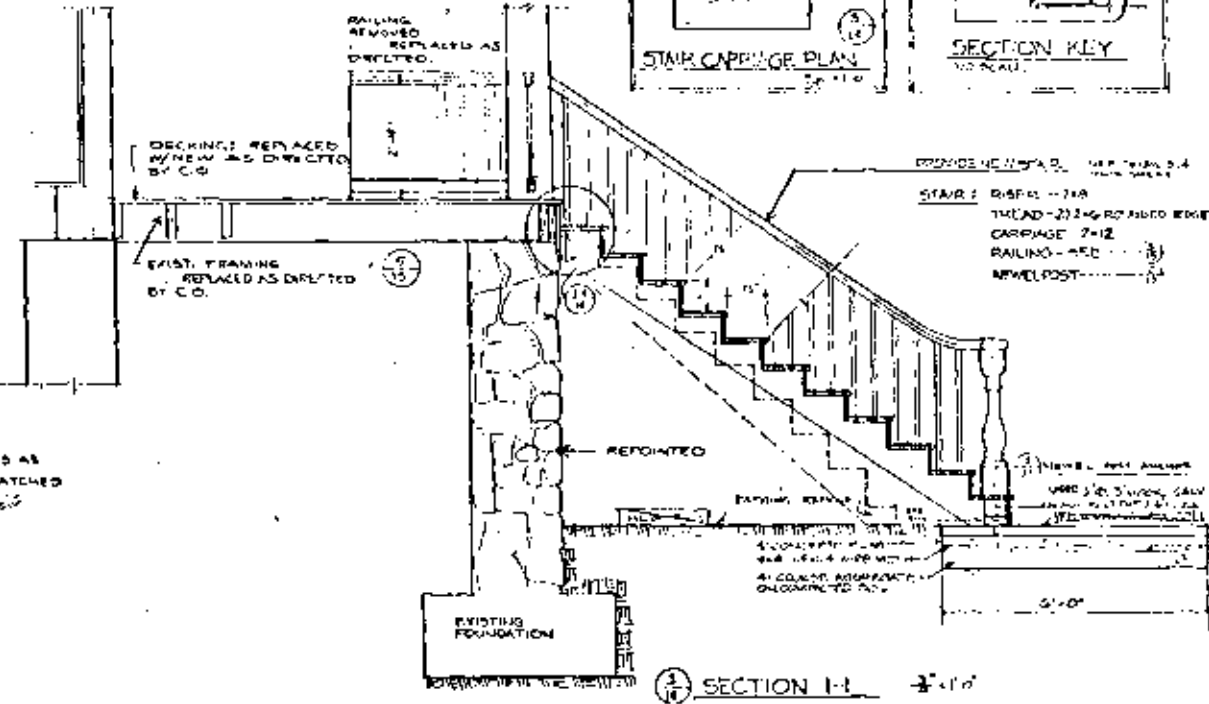
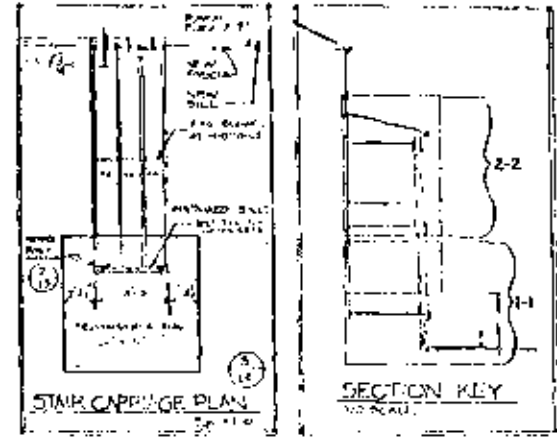
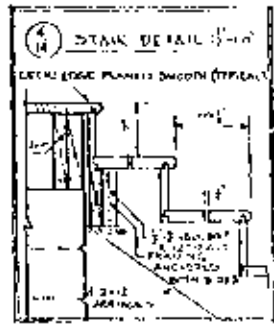
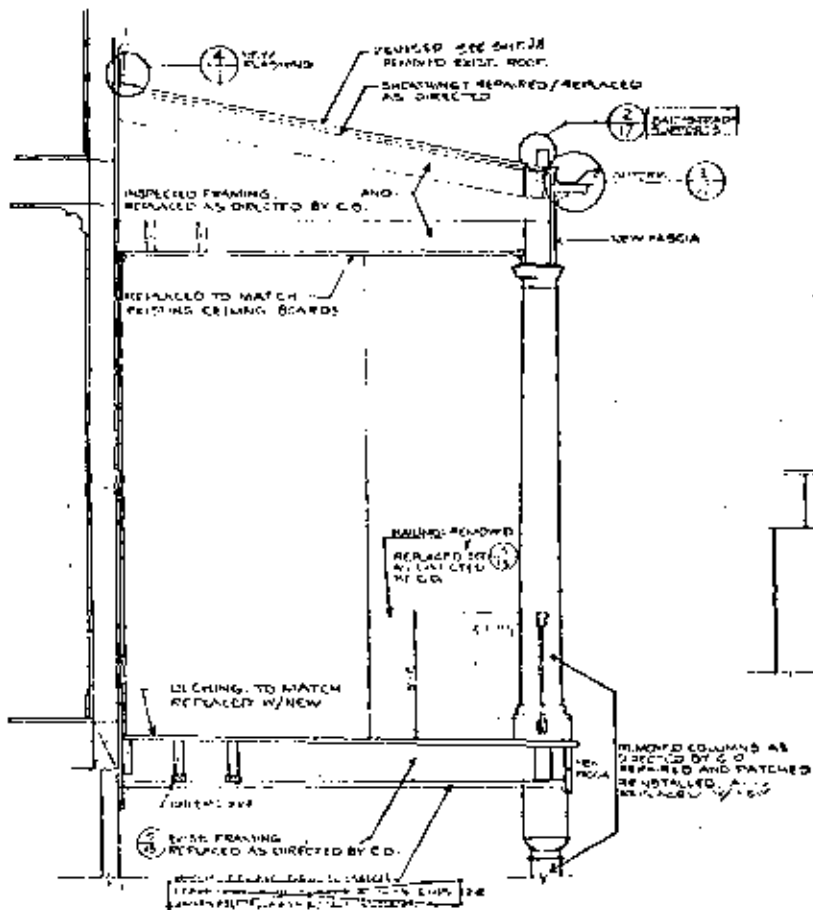

SECTION 2-2

SECTION 1-1

EAST PORCH DETAILS

PREPARED BY	DATE
CHECKED BY	DATE
DESIGNED BY	DATE
IN CHARGE	DATE
SCALE	AS SHOWN
SHEET NO.	18
TOTAL SHEETS	24

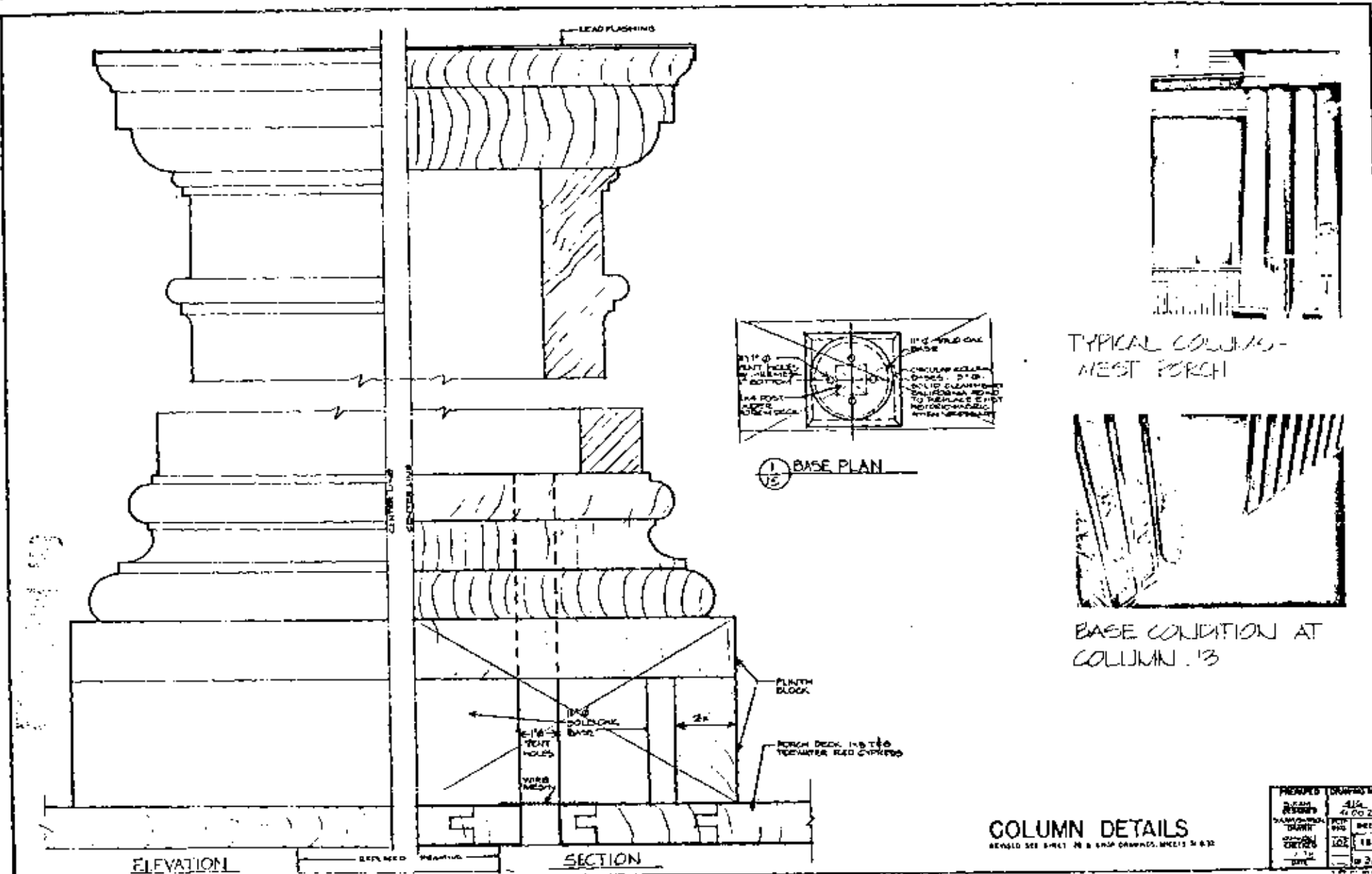

TYPICAL COLUMN - NEST PORCH



BASE CONDITION AT COLUMN '13

COLUMN DETAILS
 REVISD SEE SHEET NO. 2 AND DRAWINGS, SHEETS 3 & 4

REVISED	DRAWING NO.
BY: [initials]	414
CHECKED: [initials]	4 00 2 1
DATE: [initials]	18
SCALE: [initials]	1/2" = 1'-0"
PROJECT: [initials]	2A



BRICK CHIMNEY NO. 4



MAIN ROOF - LRG SOUTH

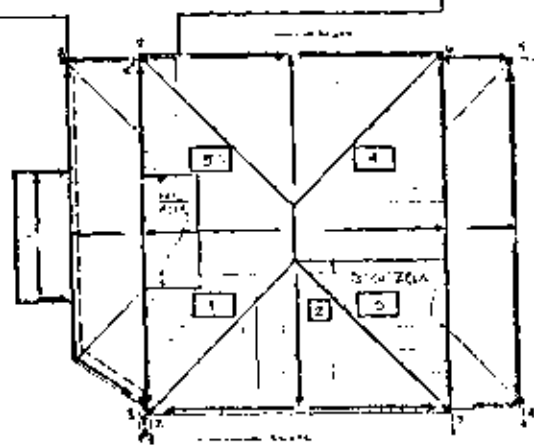

ROOF DRAINAGE PLAN
REVISED SEE SHEET 17

REMOVED ALL EXIST GUTTERS AND LEADERS
REPLACE WITH 4" DIA GUTTERS AND NEW VERTICAL
LEADERS TO BE INSTALLED IN BACKLASH OF GUTTER
LEADERS TO BE INSTALLED TO MATCH EXISTING
LEADERS TO STAIRWAY CONNECTIONS TO STORAGE.

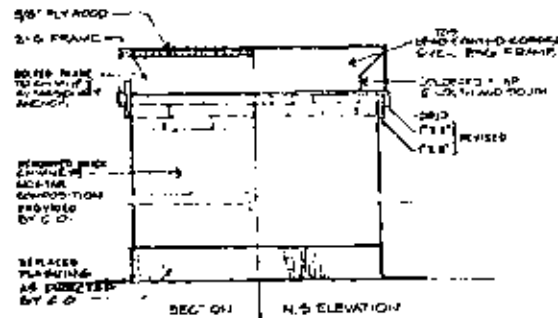

CHIMNEY CAP
SCALE 3/8"=1'-0"
REVISED FROM FIRST DRAFT AT
AN EARLY STAGE

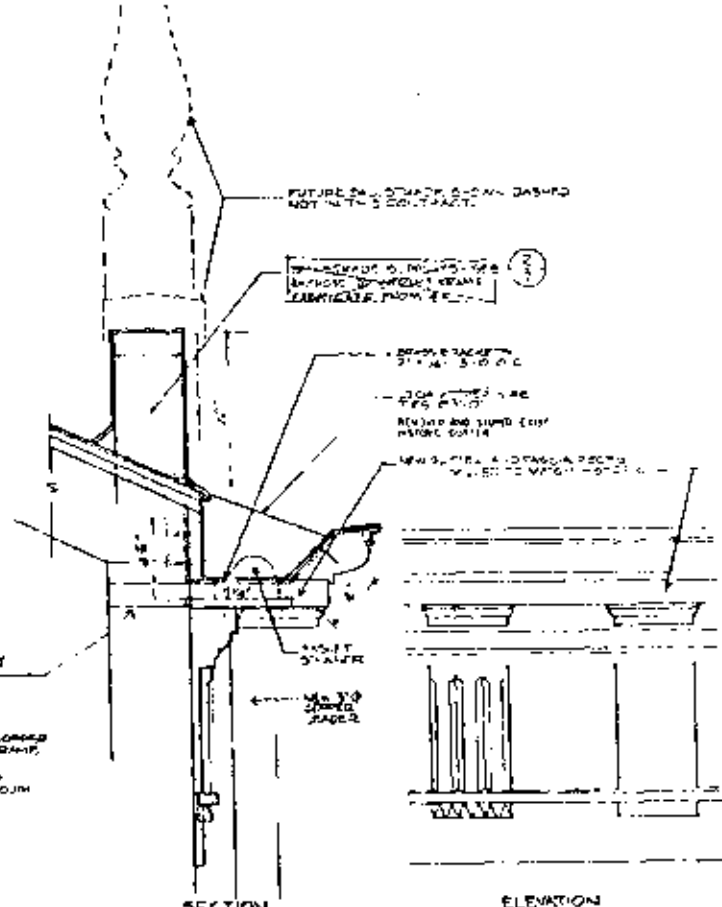

SECTION
GUTTER ASSEMBLY MAIN ROOF
SCALE 3/8"=1'-0"
REVISED SUPPLY REF SHEET 15

MAIN ROOF DETAIL

PROJECT NO.	416
DATE	4/10/57
BY	WJ
CHECKED BY	WJ
SCALE	AS SHOWN
DATE	4/10/57
BY	WJ
CHECKED BY	WJ

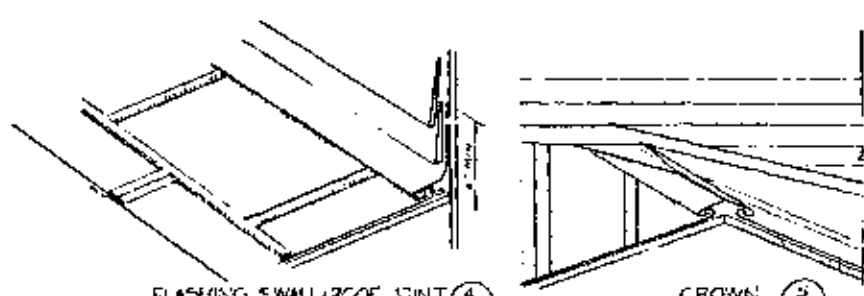

FLASHING, WALL/ROOF JOINT (4) NOT TO SCALE

CROWN (5) NOT TO SCALE

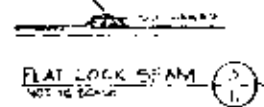

FLAT LOCK SEAM (6) NOT TO SCALE

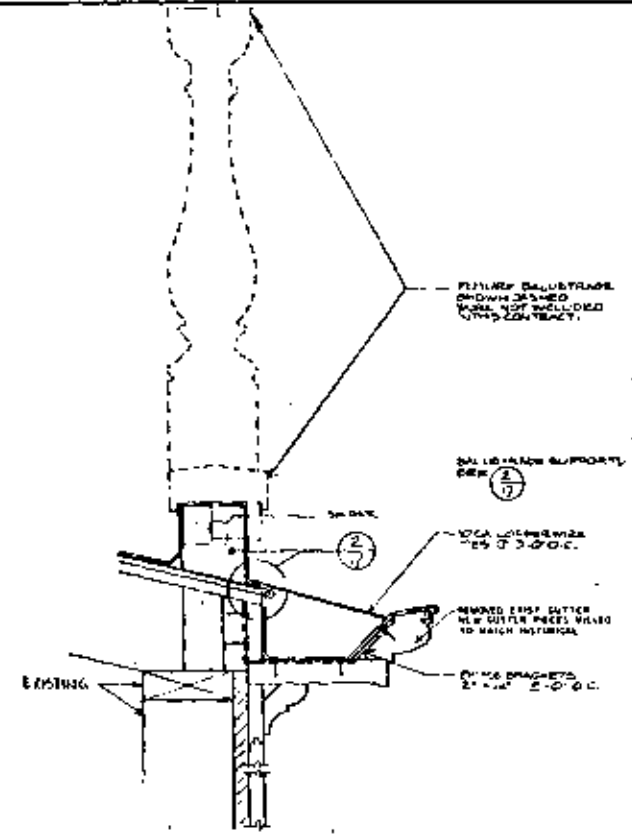

GUTTER ASSEMBLY & PORCH (1) SEE SHEET 18

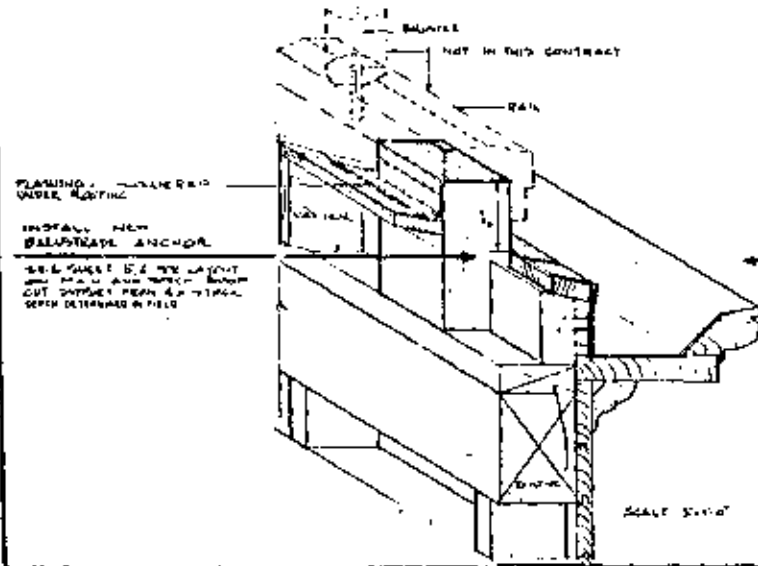

SCALE 3/4" = 1'-0"

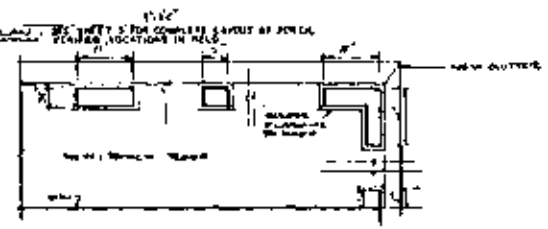

PORCH ROOF DETAILS

REPLACED - SEE SHEET 21

PREPARED BY REVISED BY DRAWN BY CHECKED BY DATE	DRAWING NO. 41002A SHEET 13 OF 24
---	---

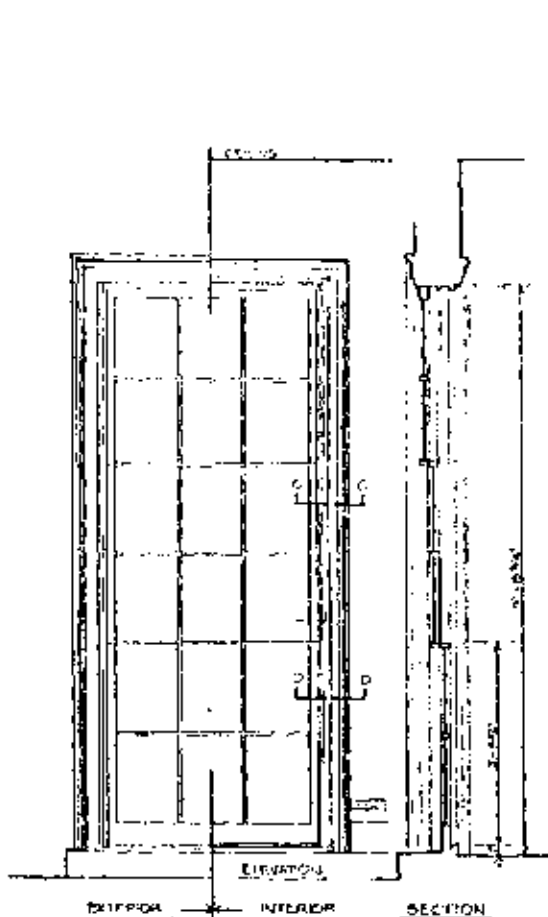

EXTERIOR INTERIOR SECTION

104, 105, 106 114, 115, 116
FIRST FLOOR BAY WINDOWS TRIPLE HUNG

18

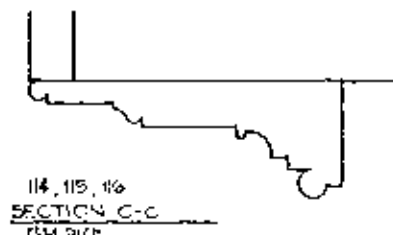

114, 115, 116
SECTION C-C
FULL SIZE

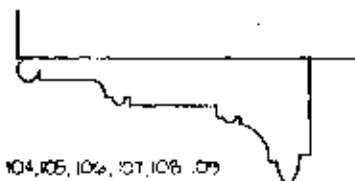

104, 105, 106, 107, 108, 109
SECTION D-D

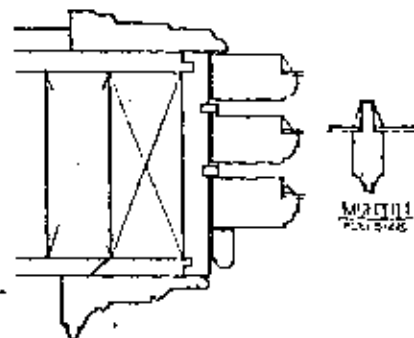

JAMB SECTION
NO SCALE

2
15

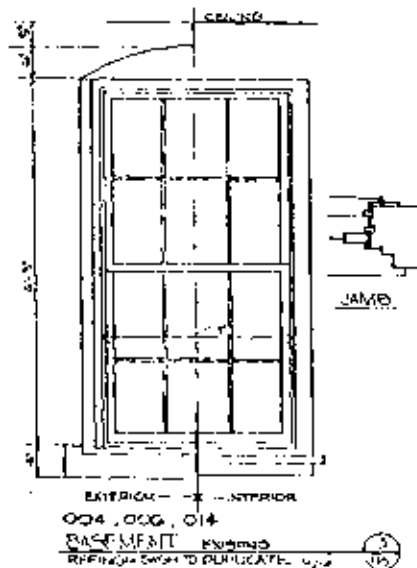

EXTERIOR INTERIOR
004, 006, 014
BASEMENT

JAMB

3
15

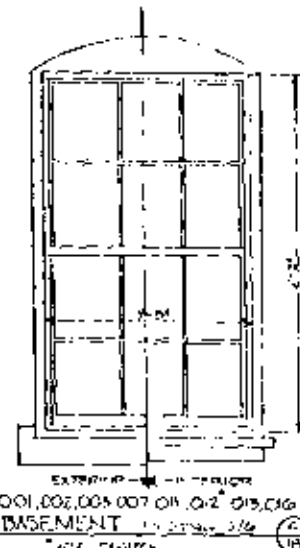

EXTERIOR INTERIOR
001, 002, 003, 007, 011, 012, 013, 016
BASEMENT

4
15

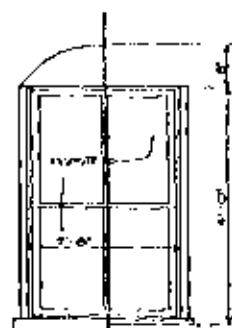

EXTERIOR INTERIOR
008 BASEMENT

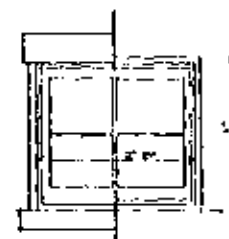

EXTERIOR INTERIOR
0006, 9 SUBBASEMENT

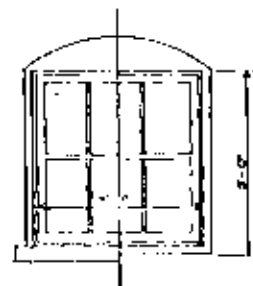

EXTERIOR INTERIOR
0007, 6 SUBBASEMENT

WINDOWS: BASEMENT
& FIRST FLOOR BAY

PREPARED BY	DATE
DRAWN BY	NO.
CHECKED BY	18
SCALE	AS SHOWN

111, 112, 113
SECTION E-E

102, 103 204-212
SECTION F-F

213, 214
SECTION D-D

215
SECTION G-G

216
SECTION H-H

FIRST FLOOR WINDOWS

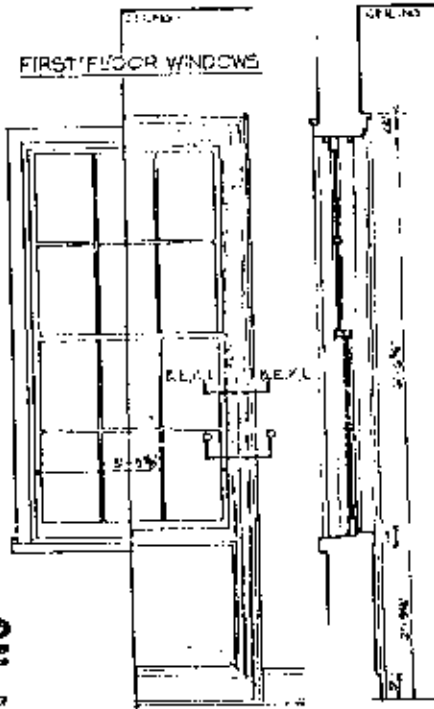

SECTION 1
TYP. FIRST FLOOR WINDOW

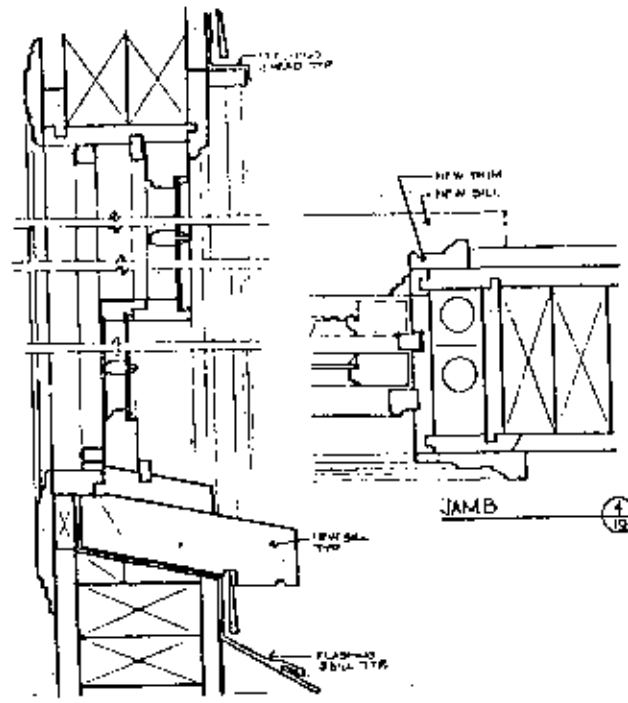

SECTION 2
HEAD AND SILL TO DATE

SECOND FLOOR WINDOWS

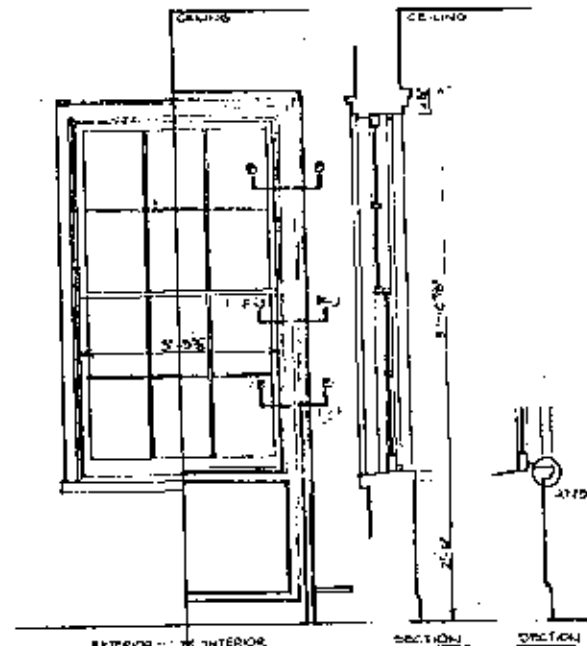

SECTION 3
TYP. SECOND FLOOR WINDOW

NOTE:
ALL MILLWORK SECTIONS
THIS PAGE ARE DRAWN FULL SCALE
ON 24" SHEET TO THE SQUARE

110
SECTION K-K

202, 203
SECTION I-I

205
204

SECTION J-J

118
SECTION L-L

WINDOWS: FIRST &
SECOND FLOOR

REVISIONS	DATE
1	11/11/20
2	11/11/20
3	11/11/20
4	11/11/20
5	11/11/20
6	11/11/20
7	11/11/20
8	11/11/20
9	11/11/20
10	11/11/20
11	11/11/20
12	11/11/20
13	11/11/20
14	11/11/20
15	11/11/20
16	11/11/20
17	11/11/20
18	11/11/20
19	11/11/20
20	11/11/20
21	11/11/20
22	11/11/20
23	11/11/20
24	11/11/20
25	11/11/20
26	11/11/20
27	11/11/20
28	11/11/20
29	11/11/20
30	11/11/20

WINDOW SCHEDULE

LOCATION	NUMBER	SIZE	TYPE	REMARKS	
B	NONE			RE WINDOWS RECEIVED STANDARD TREATMENT AS OUTLINED IN SPEC. LISTED	
W	NONE				
SUBSEVEN	N	0006, 0009	2'-6" x 2'-4"	CASEMENT (W)	GLAZ. WEATHERIGHT W/LEAD GLASS
	S	0001, 0002	5'-2" x 3'-0"	CASEMENT (W)	GLAZ. WEATHERIGHT W/LEAD GLASS
	E	0005, 0007, 0008, 0007	3'-0" x 4'-3"	DBL. HUNG (W)	GLAZ. W/LEAD GLASS TO BE
BASEMENT	W	0011, 0012, 0013, 0014	3'-0" x 4'-6"	DBL. HUNG (W)	31 - 1905-TYPE GLASS OR CHANGED TO 0/0/0
	N	0004	2'-8" x 4'-0"	DBL. HUNG (W)	TRIMMED & ADJ.
	N	0011, 0012, 0013	3'-0" x 4'-6"	DBL. HUNG (W)	STANDARD TREATMENT - SEE SPEC.
	F	0014, 0015, 0016	3'-0" x 3'-0"	DBL. HUNG (W)	STANDARD TREATMENT
1st FLOOR	N	0017, 0018, 0019	3'-0" x 3'-0"	DBL. HUNG (W)	STANDARD TREATMENT
	S	0021, 0022	3'-0" x 3'-0"	DBL. HUNG (W)	STANDARD TREATMENT
	E	0023, 0024, 0025, 0026	3'-0" x 3'-0"	DBL. HUNG (W)	STANDARD TREATMENT
2nd FLOOR	N	0027, 0028, 0029, 0030	3'-0" x 3'-0"	DBL. HUNG (W)	STANDARD TREATMENT
	W	0031, 0032, 0033, 0034	3'-0" x 3'-0"	DBL. HUNG (W)	STANDARD TREATMENT
	S	0035, 0036	3'-0" x 3'-0"	DBL. HUNG (W)	STANDARD TREATMENT

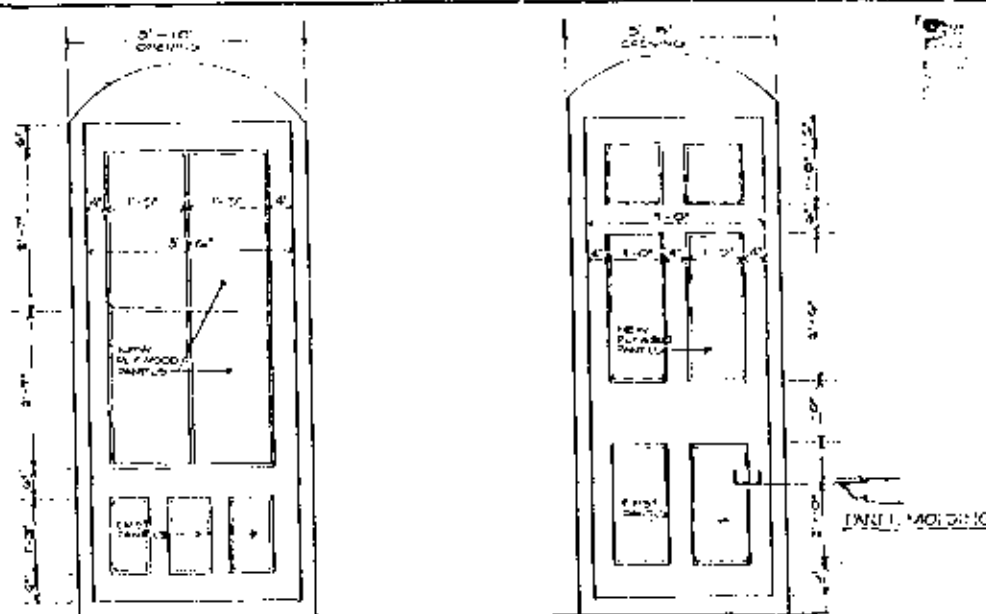

016 FRONT DOOR - BASEMENT - 005 REAR DOOR

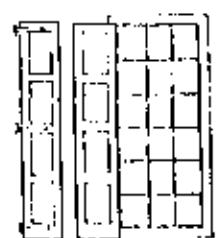

FIRST FLOOR BAY WINDOW TYPE A

SHUTTER SCHEDULE			
FLOOR	LOCATION	QUANTITY	REMARKS
FIRST FLOOR	A - BAYS	6 PAIR	REMOVE & REPAIR
	B - EAST	2 PAIR	REMOVE AND REPAIR
SECOND FLOOR	C - WEST	4 PAIR	REMOVE & REPAIR
	D - EAST	4 PAIR	REMOVE & REPAIR



FIRST FLOOR TYPE B

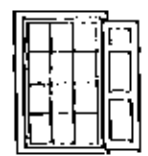

SECOND FLOOR TYPE C (TYPE C STORED IN BASEMENT)

DOOR SCHEDULE		
NO.	SIZE	REMARKS
016	5'-0" x 7'-0"	REMOVED BOTH EXISTING DOORS; INSTALLED REPAIRED PANEL DOOR
005	5'-0" x 7'-0"	REMOVED EXIST. DOOR; INSTALLED REPAIRED PANEL DOOR
017	3'-0" x 7'-0"	EXISTING DOOR REMAINS; REPAIRED CRACKED PANELS
018	5'-0" x 7'-0"	EXISTING DOOR REMAINS; REPAIRED CRACKED PANELS

- NOTES:
- WINDOWS - STANDARD TREATMENT SEE SPEC. GRASS. REPAIRS TO BE MADE WHERE DIRECTED. REPAIRS TO BE MADE WITH ORIGINAL OR EQUAL GLASS & GLAZING. REINSTALL SASH, REPLACE GASKETS, WEIGHTS, ROLLERS.
 - SHUTTERS - REMOVED, STRIPPED AND REPAIRED, REPAIRED.
 - DOORS - REPAIRED AND STRIPPED IN PLACE. LOCAL DOORS - OAK - OLD PRESERVELY STAINED. NEW DOORS - OAK - NEW PRESERVELY STAINED. DETAIL AS SHOWN.

SCHEDULES: WINDOWS, DOORS, & SHUTTERS

REVISION	DATE
1	11/10/20
2	11/10/20
3	11/10/20
4	11/10/20
5	11/10/20

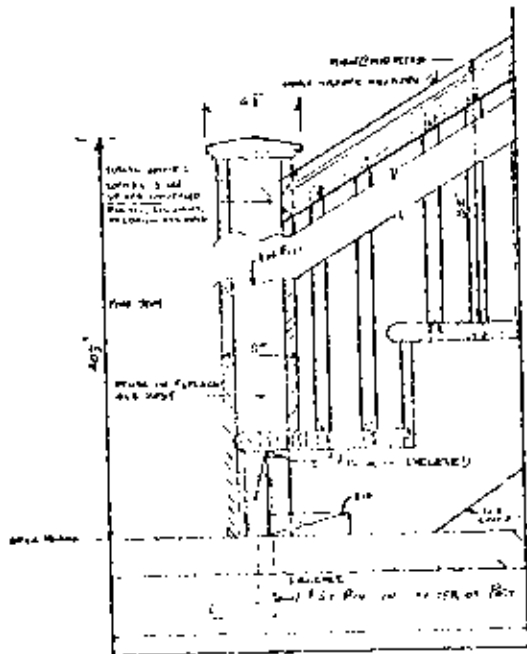

1. SECTION THROUGH POST
5/11/51

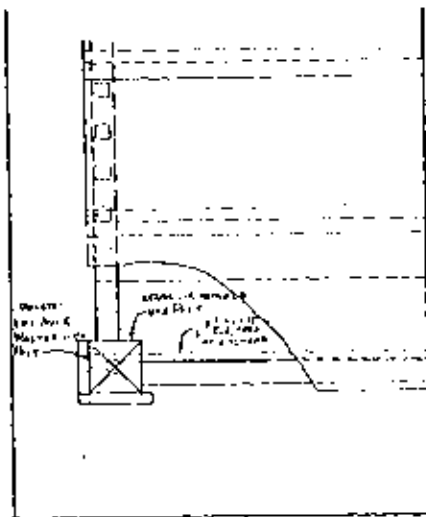

2. PLAN OF MULLION POST
5/11/51

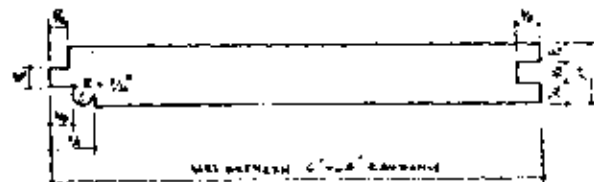

LEGEND: WOOD BOARD
MULLION - CROSS / 1/2\"/>

4. PROPOSED CEILING BOARD FULL SIZE / EX. 5

5. CEILING BOARD FULL SIZE SEE SHEET 28

(SKS)
(SKT)

REVISED (1951) DRAWING

DESIGNED BY HAMILTON CLARK ARCHITECTURE PHASE - 2 HAMILTON - 10100	DATE 5/11/51	PROJECT NO. 21	SHEET NO. 21
THE S. B. HENNINGSON COMPANY GENERAL CONTRACTORS 10100 HAMILTON	DATE 5/11/51	PROJECT NO. 21	SHEET NO. 21

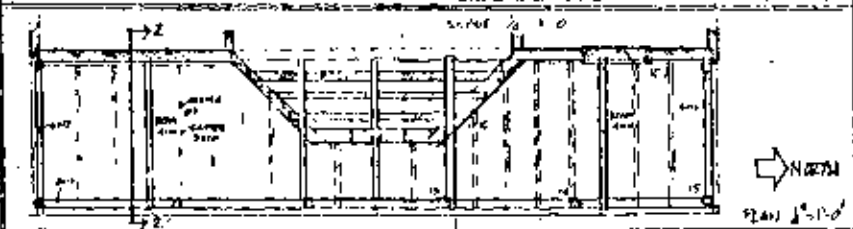
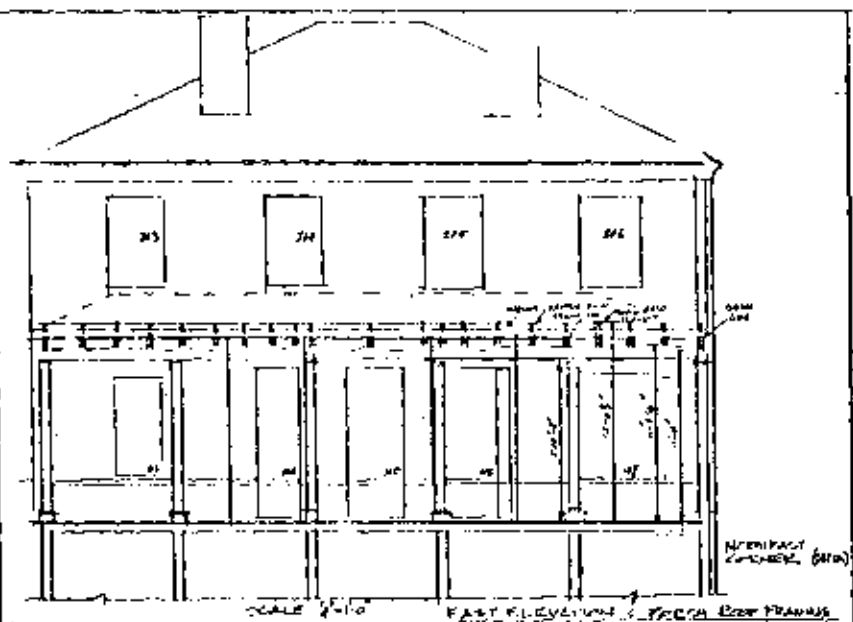
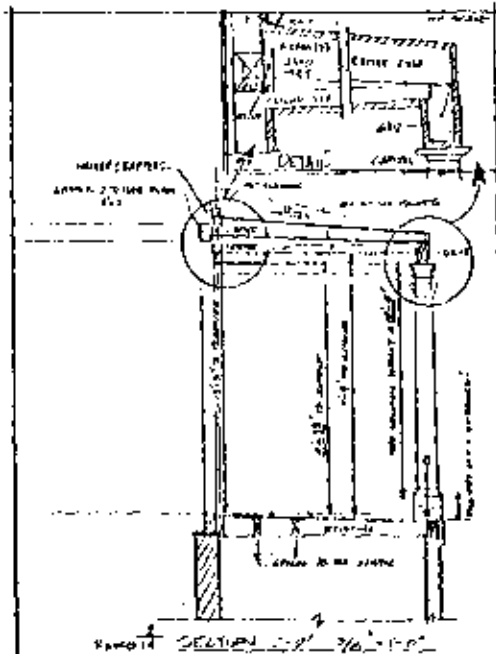

LIAMILTON GRANGE: RESTORATION
PHASE I

LIAMILTON SITE, NORTH PLAZA NY NY
 SKZ PROVIDED TO FOLLOW ROOF FRAMING
 PROVISIONAL DRAWING 1/10/70

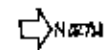

PLAN 1/10/70

1/10/70

DRAWING NO		416
PROJECT	DATE	1/10/70
DESIGNER	SCALE	1/4" = 1'-0"
CHECKED	DATE	1/10/70
DATE	SCALE	1/4" = 1'-0"

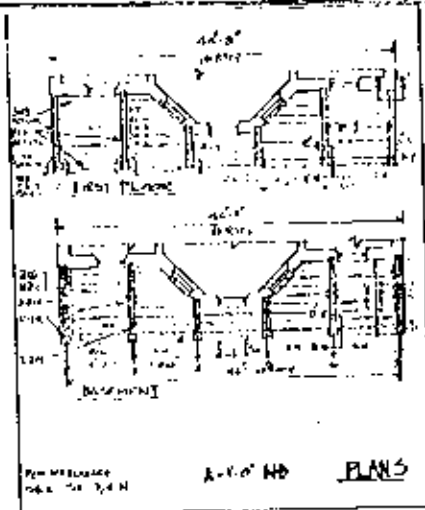

1 PLANS, FIRST FLOOR & BASEMENT SUPERSEDED BY SET 37

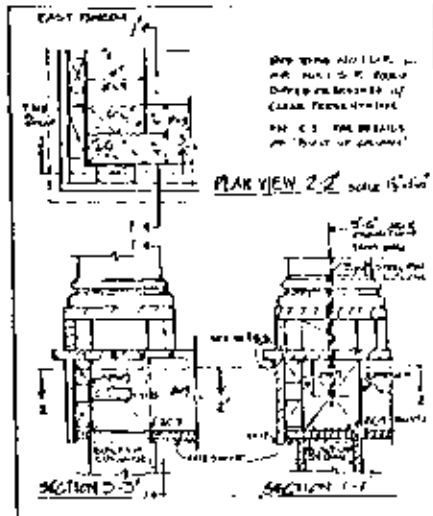

2 DETAILS & FIRST FLOOR OPENING SUPERSEDED BY SET 37

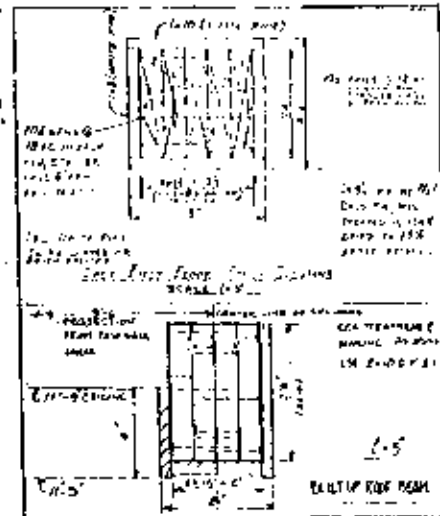

3 FIRST FLOOR WINDOW SUPERSEDED BY SET 37

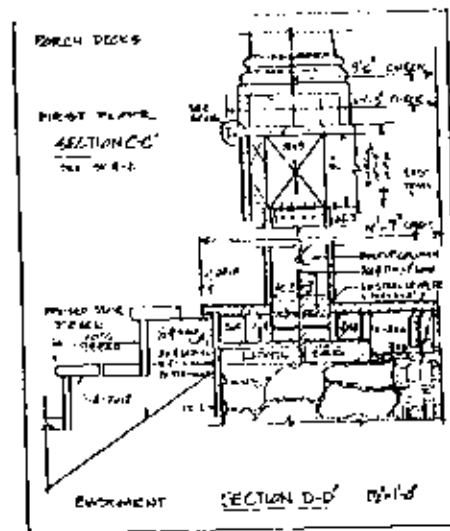

4 SECTION C-C & D-D SUPERSEDED BY SET 37

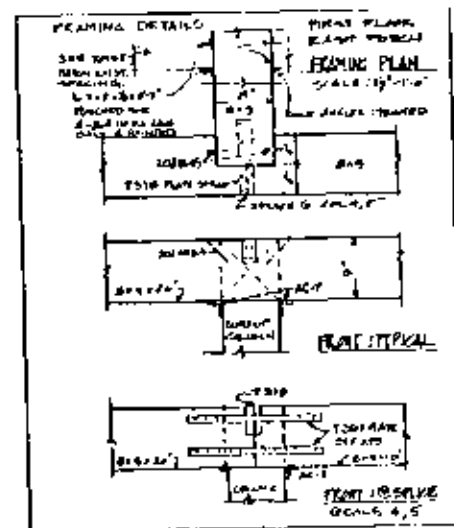

5 FRONT PORCH BEAM DETAILS SUPERSEDED BY SET 37

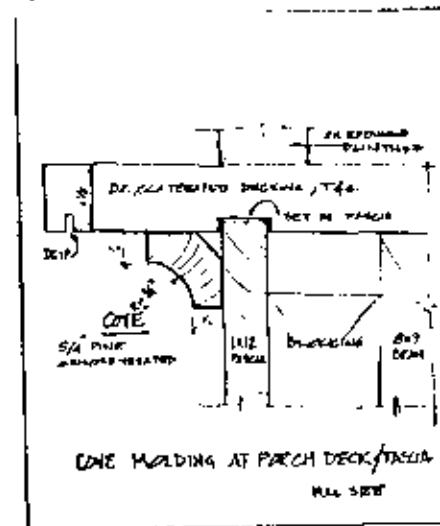

6 CONCRETE MOLDING SUPERSEDED BY SET 37

DETAILS 1, 2, 3, 4, 5 SUPERSEDED BY SET 37

DATE	2/1/51
BY	W. H. W.
CHECKED BY	W. H. W.
SCALE	AS SHOWN
PROJECT	MANHATTAN OFFICES
NO.	21
OF	24

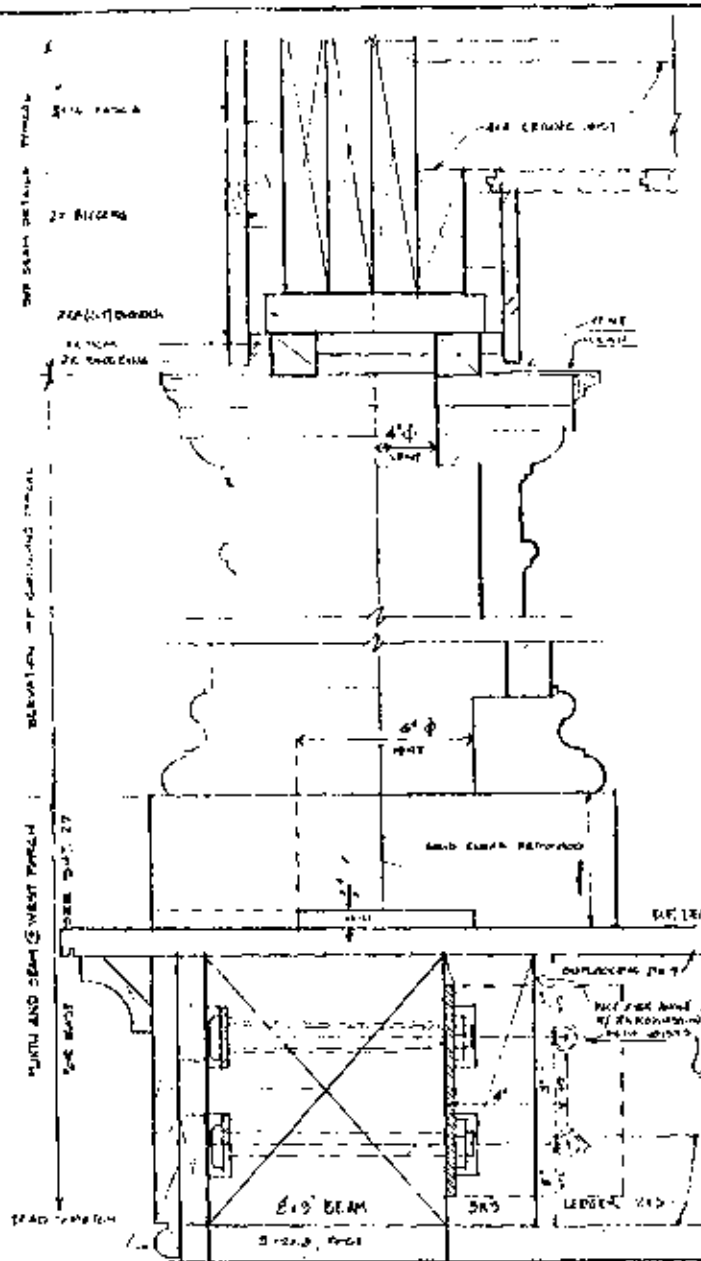

CLEARANCE NOTE:
 1- 2" CLEARANCE TO
 2- 1/2" IN 17" WALLS IN WORK
 AT CONNECTION BETWEEN
 2x12 BEAM & COLUMN. CLEARANCE
 NEAR COLUMN TOP
 APPROX. 1/4" MINIMUM 1/2"

1 SECTION 1-1
 HALF SIZE

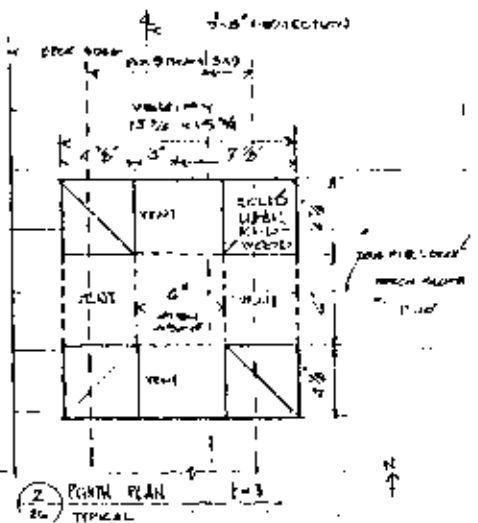

NO. 10 REINFORCING
 BARS TO BE USED
 THROUGHOUT

TYPICAL NO. 7
 COLUMN WEIGHTS
 HORIZONTAL BEARING
 BRACKETS TO BE PROVIDED
 ON EACH SIDE OF 1/2"
 MAXIMUM DIA.

DESIGNED FOR 25,000 LBS.

COLUMN DETAILS

PREPARED BY	DATE	DRWING NO.
CHECKED BY	11/21/54	4172-A
DESIGNED BY		20
SCALE		1/2" = 1'

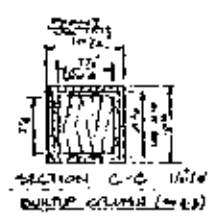
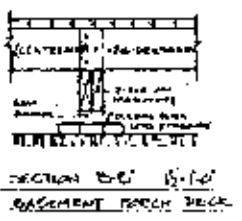
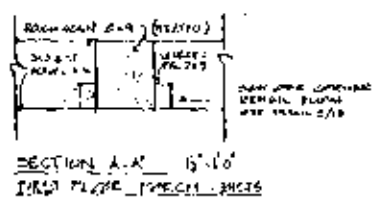
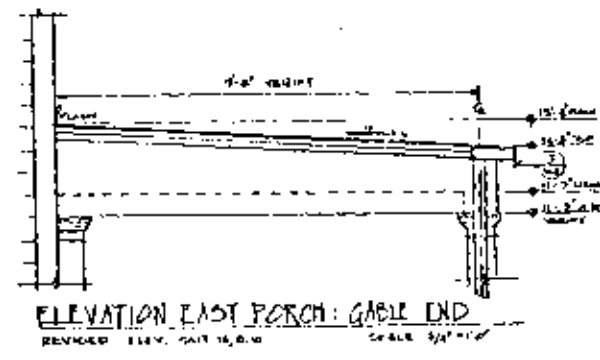
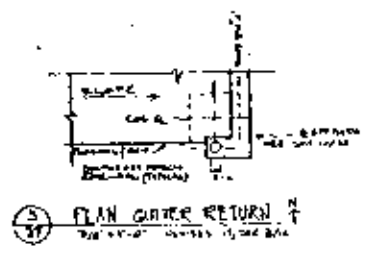
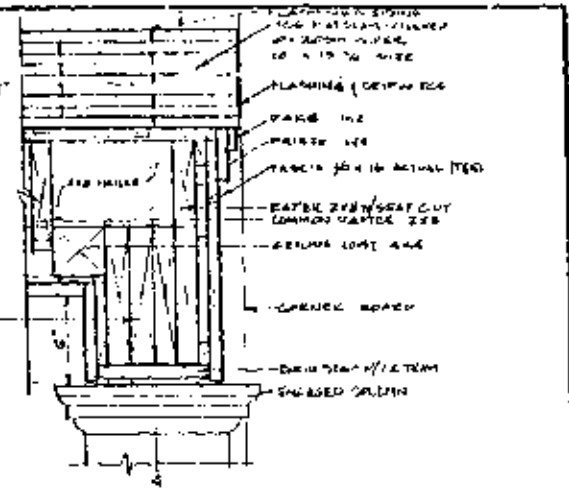
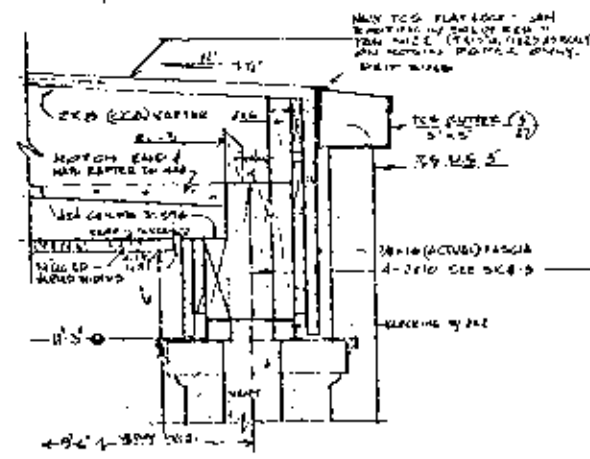
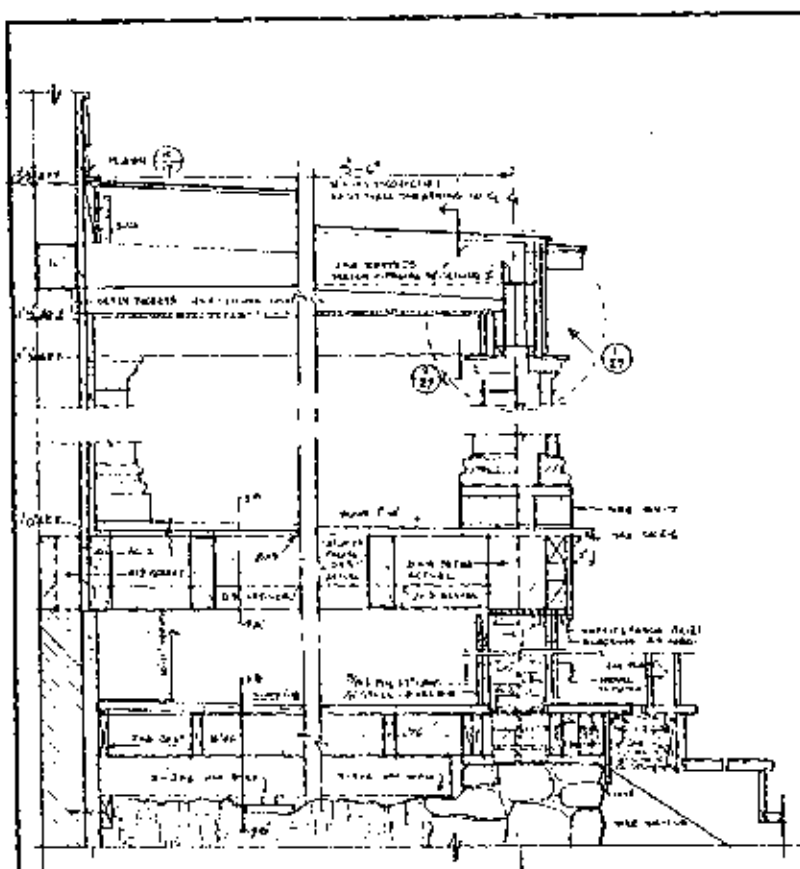

REVISED 11/27/54 BY RAN	DATE	BY
REVISIONS	NO.	DATE
1	11/27/54	RAN
2		
3		
4		
5		
6		
7		
8		
9		
10		
11		
12		
13		
14		
15		
16		
17		
18		
19		
20		
21		
22		
23		
24		
25		
26		
27		
28		
29		
30		



AS SHOWN ABOVE
FULL SIZE 1/4" = 1'-0"

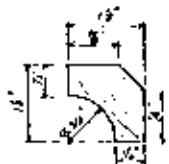

WINDOW SILLING WITH SLOPE
FULL SIZE TREATED PINE 1/4" = 1'-0"

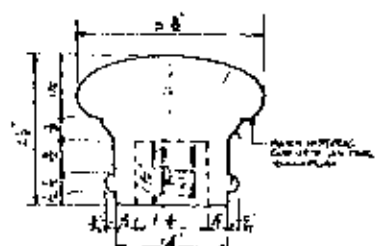

HISTORIC HANDRAIL & BALUSTERS
FULL SIZE TREATED PINE 1/4" = 1'-0"

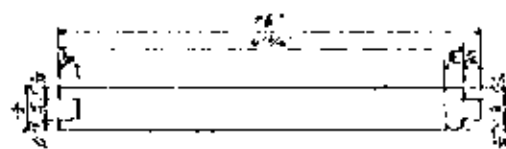

CEILING CASING

WEIRD NOTING AS NOTED YELLOW CEDAR CLEAR WOOD

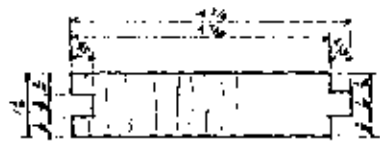

BEAM CASING

VERT. GRAIN 1/2" PIR

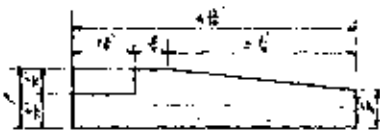

BEAM CASING

YELLOW CEDAR CLEAR WOOD

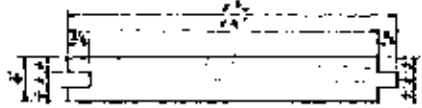

PLINTH MOLDING

PLAIN GRAIN - CLEAR WOOD

FULL SIZE PROFILES

ARCHIVE FOR ARCHIVE SYSTEM

SK-9 - SHEETS

REVISED	DATE	BY	CHKD BY

NEW MILLWORK PROFILES
 MATERIALS LISTED
 MATERIALS LISTED
 MAKE THE ARCHIVE SYSTEM
 MAKE THE ARCHIVE SYSTEM
 MAKE THE ARCHIVE SYSTEM
 MAKE THE ARCHIVE SYSTEM
 MAKE THE ARCHIVE SYSTEM

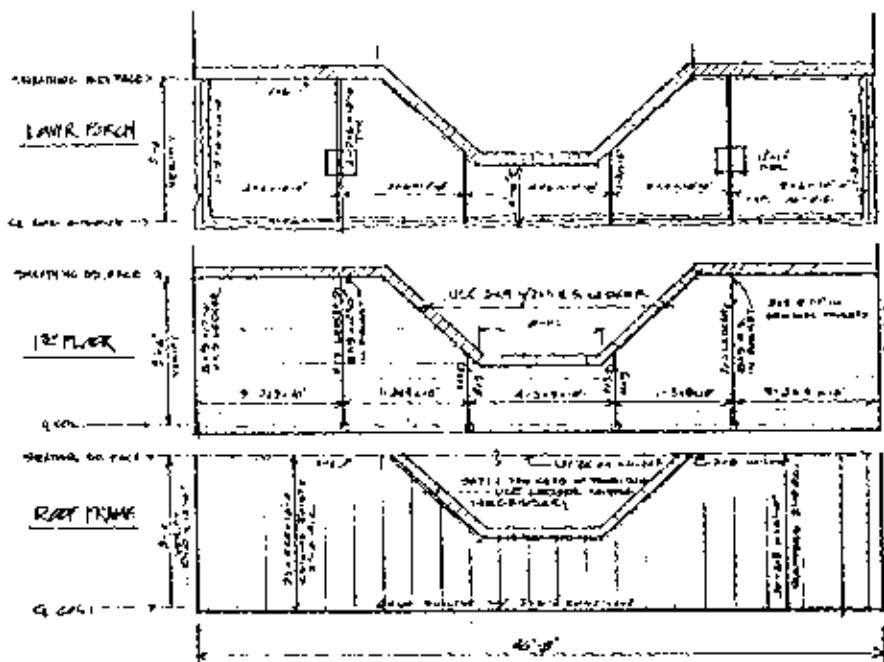

① EAST PORCH
SEE THAT OTHER SHEETS FOR DETAILS

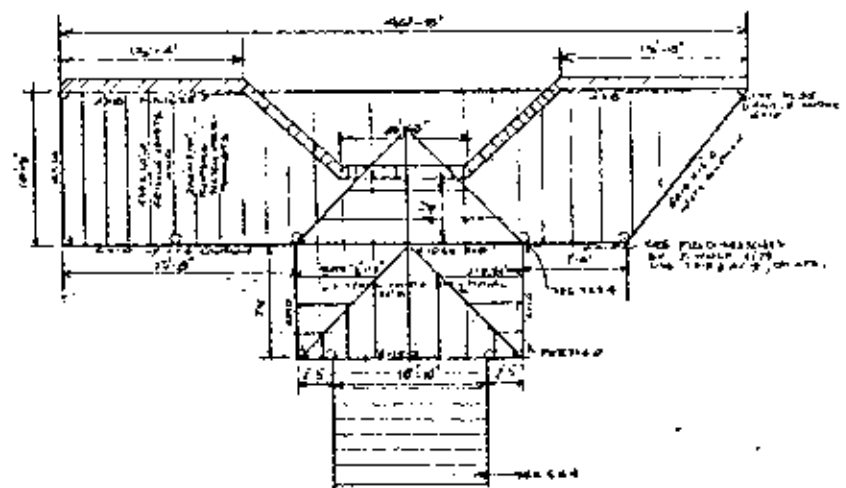

② WEST PORCH ROOF FRAMING PLAN
SEE THAT OTHER SHEETS FOR DETAILS

ONE SET OF
DRAWINGS FOR AS BUILT SET/00

REVISIONS	DATE	BY	CHKD BY	NO.

REVISIONS

NO.	DESCRIPTION

REVISIONS

NO.	DESCRIPTION

REVISIONS

FIELD MEASUREMENTS AS PER U.C. 11/1/11

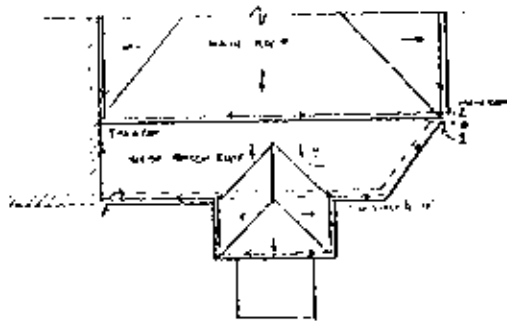

7 DRAINAGE PLAN WEST PORCH ROOF
SEE SHEET 12/10 FOR MAIN ROOF

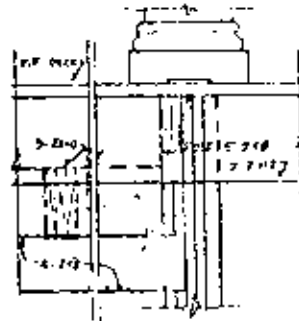

5 NEW DRAIN AND DRAIN COLLECTOR
SCALE 1/2" = 1'-0" SECTION 5-5
REVISED FOR 12 BUILT 11/10

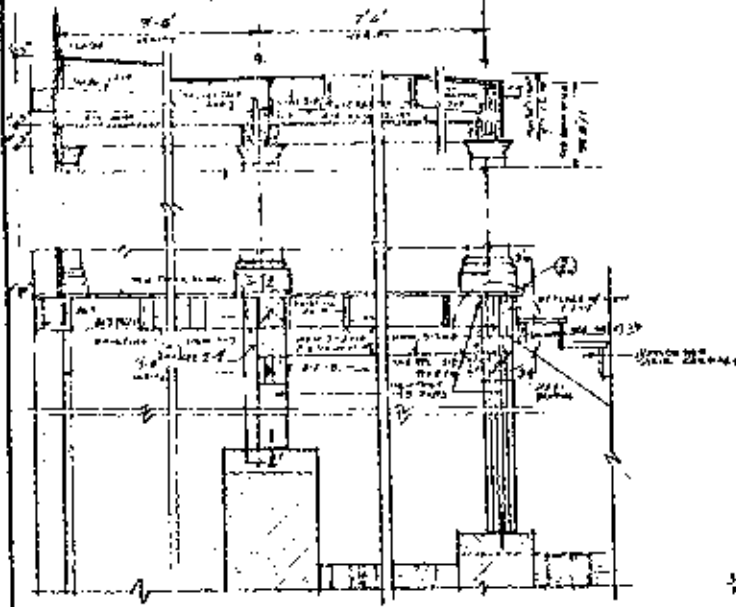

1 SECTION 1-1 WEST PORCH & PORTICO STEPS
SCALE 3/8" = 1'-0" SEE CENTERLINE FRAMING PLAN

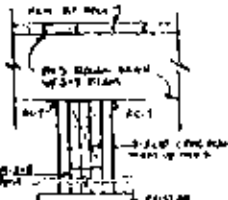

2 SECTION 2-2
SCALE 1/2" = 1'-0" REVISED SEE 5

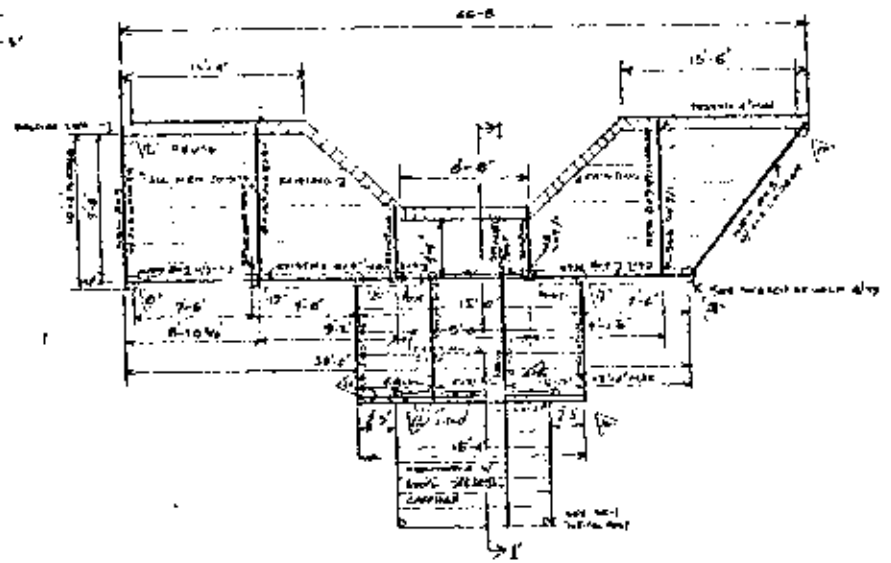

4 WEST PORCH DECK FRAMING PLAN 3/8" = 1'-0"
SEE SHEET 12/10, (6) FOR DET.

12/10
12/10
12/10

△ COLUMN NO.

← 311

REVISED FOR 12 BUILT 11/10

WEST PORCH DECK FRAMING PLAN	REVISED FOR 12 BUILT 11/10
SCALE 3/8" = 1'-0"	DATE 12/10
DESIGNED BY [Signature]	CHECKED BY [Signature]
DRAWN BY [Signature]	DATE 12/10

FILE MEASUREMENTS AS NOTED OTHERWISE

NOTES: 1. ALL DIMENSIONS TO FACE UNLESS OTHERWISE NOTED.
2. ALL CLEARANCES TO FACE UNLESS OTHERWISE NOTED.

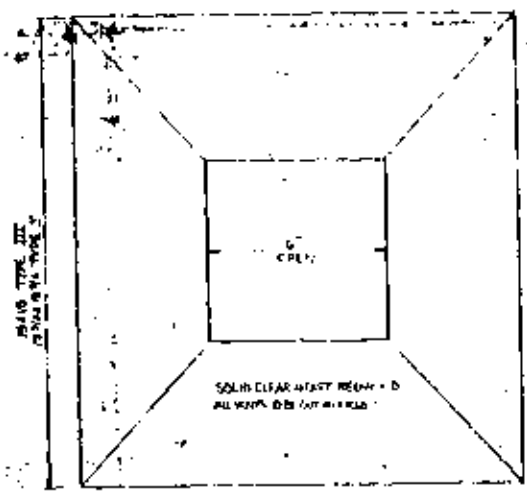
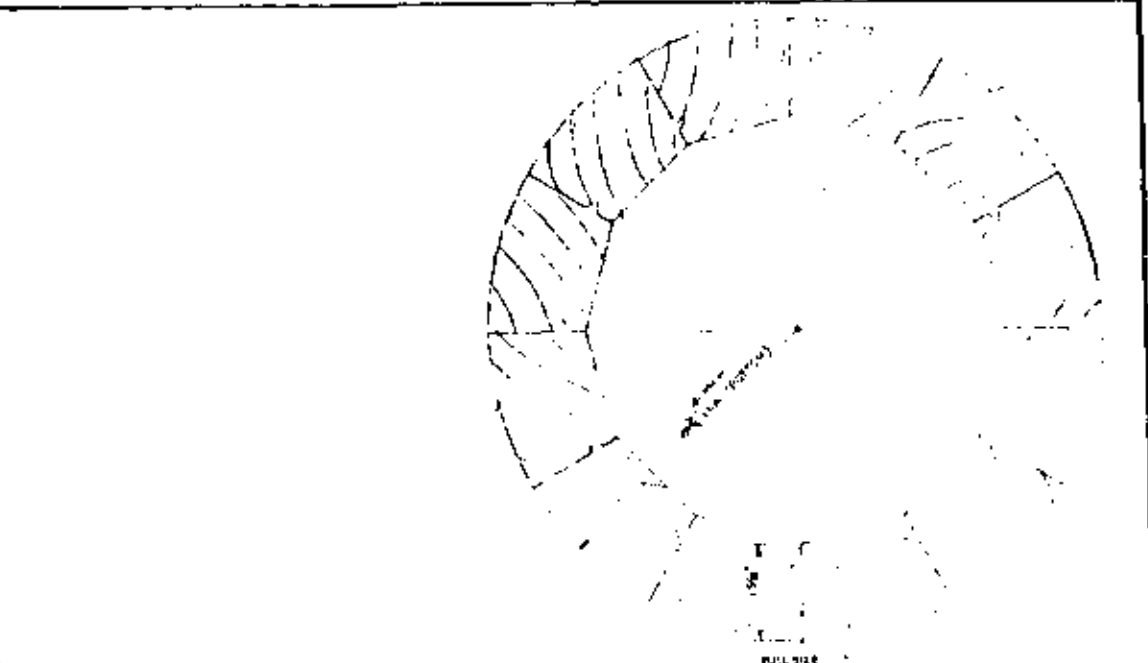
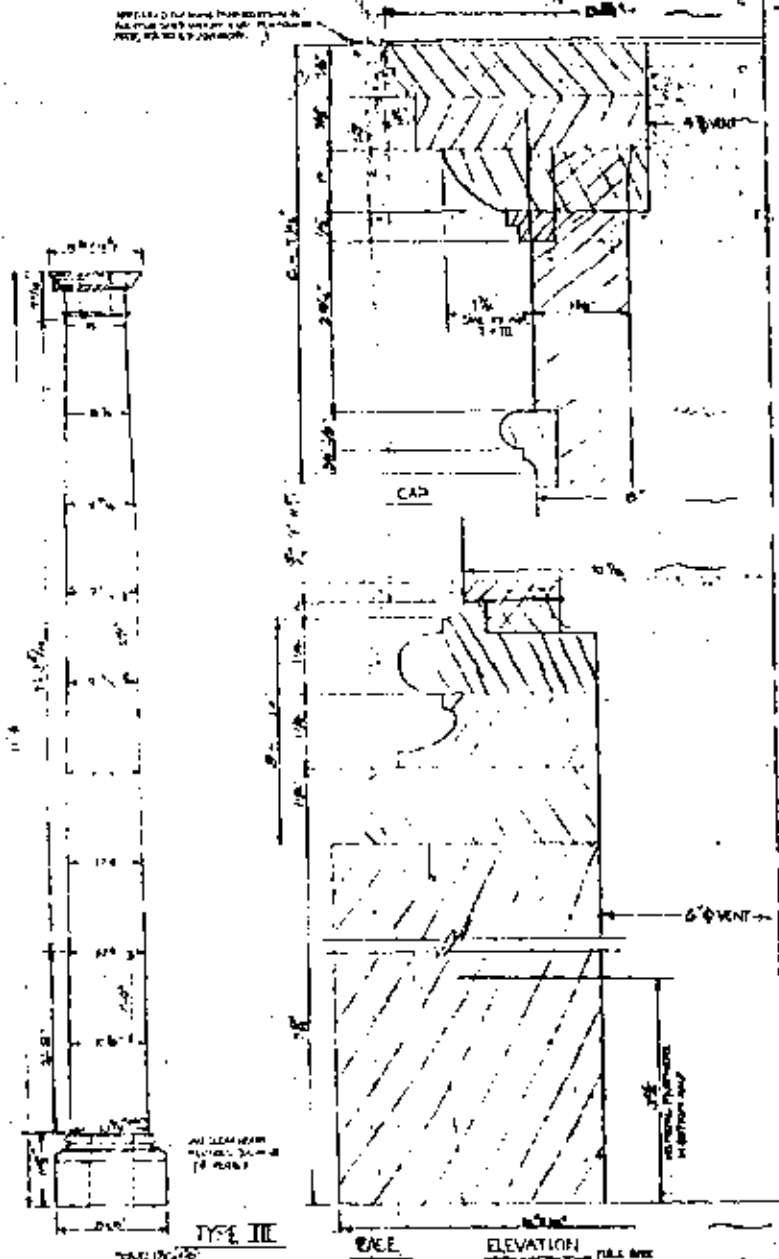

S HERBERT OBB & COLUMN CO.	
MANUFACTURERS OF COLS & MILLWORK	
SHERBERT, PENNA.	
JOB	UNIVERSITY BUILDING
LOCATION	UNIVERSITY CITY, MISSOURI
CONTRACTOR	ELLSWORTH BROS.
DATE	APRIL 1932
PROJECT	UNIVERSITY CITY
SCALE	AS SHOWN
NO.	2 OF 2

MISCELLANEOUS COLUMN
DETAILS
SCALE AS NOTED

REVISED	DRAWING NO.
BY	415
CHECKED	47002A
DATE	1932
BY	32
CHECKED	OF 34

Sketch B
6-5-37

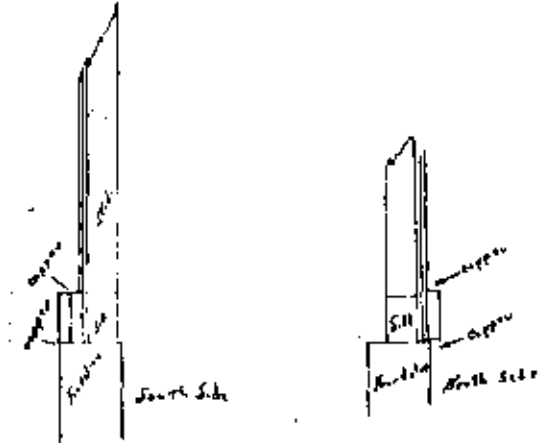

Sketch A
6-5-37

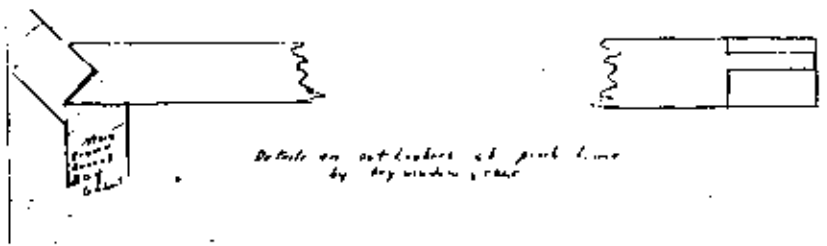
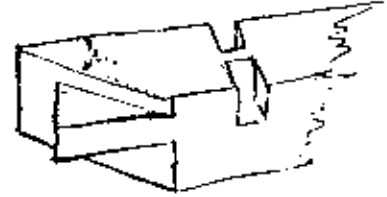

April 27/1937
W.C.

Sketch C
6-5-37

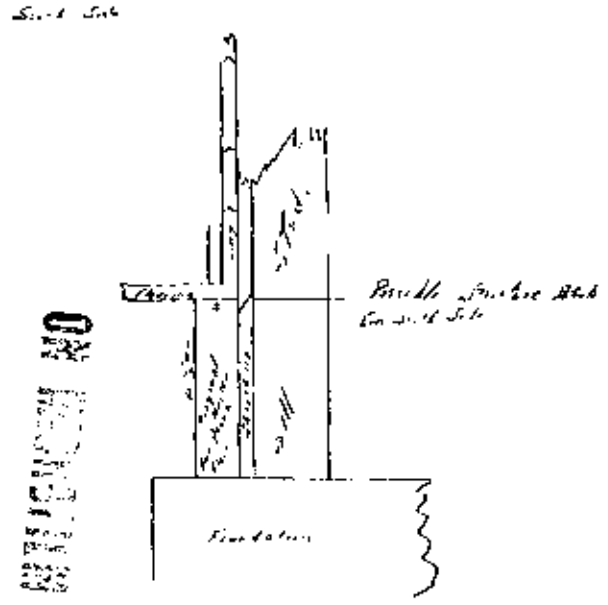

Sketch D
6-5-37

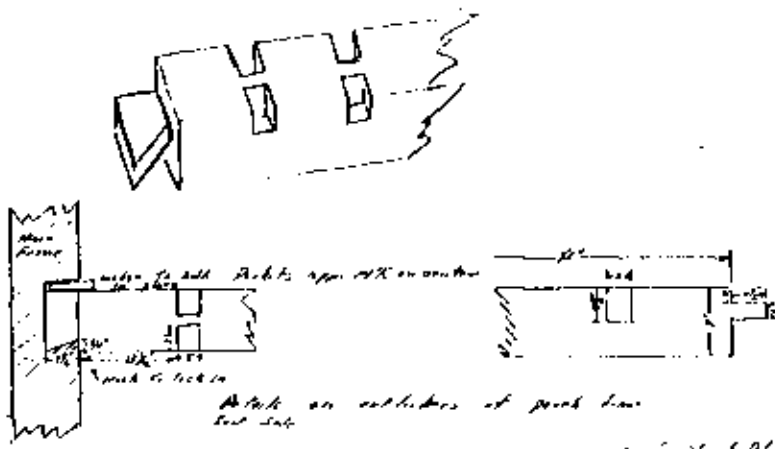

W.C.
12.11.37

transfer 2.16.38 (W.C.)

MISCELLANEOUS DETAILS
NOT TO SCALE

FILE NO. 10	DATE
REVISED BY	DATE
CREATED BY	DATE
NO. 10	33
NO. 10	34

Sketch rest out of
building showing all other
steps leading to substructure

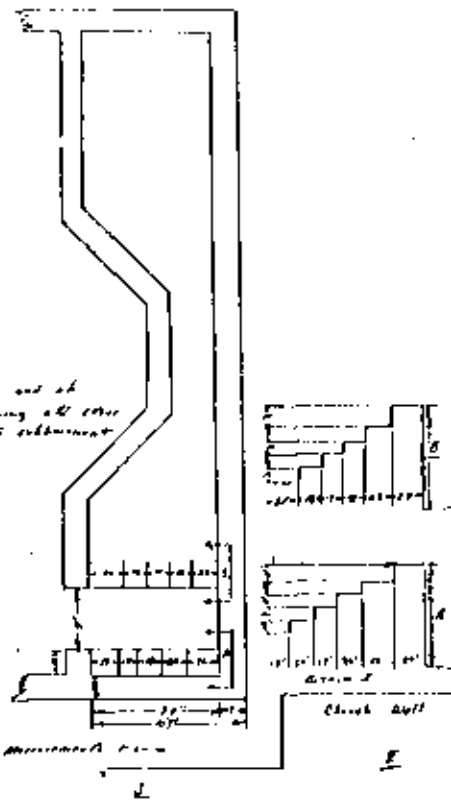

MAINT
3 YARDS

SKETCH
4/2/59

Supplement to SK 4-1
4/2/59
Lower floor support
Beams
South Library

Sketch P
4-2-59

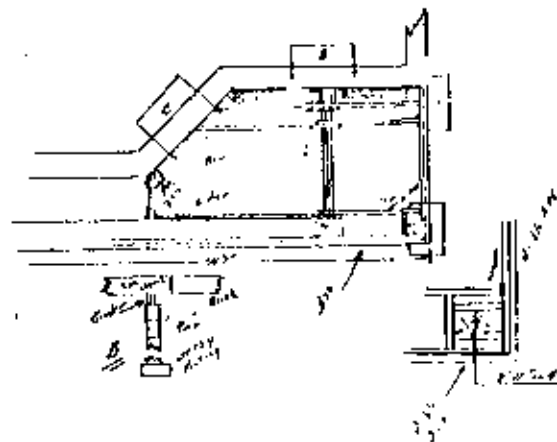

MISCELLANEOUS DETAILS
SEE TO PLAN 1

PREPARED BY	DATE	DRAWING NO.
DESIGNED BY	4/2/59	41-2-59-A
CHECKED BY		34
SCALE		1/4" = 1'-0"

Appendix L

Excerpts from
Feasibility Study for Moving and Restoring
Hamilton Grange National Memorial
by Meadows/Woll Architects

1980

SUMMARY AND RECOMMENDATIONS

We have studied the feasibility of moving the Hamilton Grange National Memorial from its present site at 141st Street and Convent Avenue to the site one block west that has been proposed for the purposes of this study and is referred to throughout this report as the study site. Many of the observations and conclusions of this report will be directly applicable to any similar site that might be proposed in the future; others, not directly applicable, may at least suggest considerations that must be taken into account in planning for any possible move. We have concluded that it is feasible in a physical and economic sense to move the building to the study site. From an architectural and historical viewpoint, however, we do not believe that it would be appropriate to move the building to this site in its present configuration.

This study has concentrated mainly--as suggested by the Scope of Services--on the physical problems of moving and restoring the Grange. The building itself appears to be structurally sound except for a separation of the framing members in the northwest corner of the attic because of previous settlement of the foundation walls. The settlement has been stabilized and the separation at the joint can be easily repaired. Because of its inherent stability, the house would require no special bracing or reinforcement to make it safe for the move.

It is certainly clear that its present site is unsatisfactory as far as the original configuration of the structure is concerned. The fact that the building is wedged between two other structures, that the front and rear entrances are both on the side, and that there is so little room for landscaping around it makes it impossible to get a real feeling of the original condition. While the study site would offer enough space to restore the building to its original configuration and allow a little landscaping, it is still too small and cramped--even more visually, perhaps, than physically. The Grange would be surrounded by tall buildings--in fact it would be very close to the backs of some tall

buildings that were never meant to be seen. Even the view from the front of the Grange across Amsterdam Avenue might not be as satisfactory as the current view from the door of the building looking across Convent Avenue. Also, because of the narrow site, it would not be possible to orientate the Grange so that it faced southwest as it did originally. In addition, parking would be limited. While historical considerations will be most important in the selection of a site and an orientation, these architectural and planning factors should also be taken into account when examining prospective sites.

Our suggested placement of the Grange on the study site would be slightly towards the northern end; the statue of Alexander Hamilton would be on the southeast corner; the gum trees would be between them. A small parking lot would be located on the northwest corner of the site.

Although it would be a major job to move such a heavy structure anywhere, it is even more complicated to move it in New York City. We estimate that the house weighs about 400 tons; the steel required to support it during the move weighs another 100 tons. Thus, a total load of 500 tons must be moved from one site to the other. It is no problem to support the building and move it. For support we recommend a three point system that will allow maximum maneuverability around the corner at Convent Avenue and 142nd street. The route of the move is relatively short and free of physical obstructions. Those obstructions that do exist are small and can be removed quickly for a relatively small price.

The two major considerations are the fact that it has to travel through the streets of New York and that the northern portion of the porch of St. Luke's Episcopal Church projects in front of it. The first problem can be handled with the help of a city agency that will coordinate the move with all public utilities and city departments. The agency has agreed with us that, while the move will be complicated, there is no physical reason that it could not be accomplished. The second problem is more serious. Although there is a clause in the deed accompanying the Grange that

permits the porch of the church to be removed and restored, the congregation would rather that did not occur. We have outlined three possible methods for moving the building. The easiest and least expensive would be to remove the porch of the church, move the Grange, and replace the porch. Either of the other methods (cutting the building in half or raising it over the porch) would cost considerably more. Because cutting the building in half would result in the destruction of much of the original fabric, we do not consider that an acceptable method; the Grange could be raised above the porch if necessary.

Another factor to be considered when selecting a site and planning for the move is the fact that, in the City of New York, the local community Board can veto permits such as those required for street and sidewalk closings. The veto of the Community Board could be overridden by the Borough President.

A consideration in the restoration of the Grange, whatever its final location, is the accessibility of the building to handicapped persons. Federal law requires that the handicapped be accommodated. The changes to the structure that would be required for full accessibility would seriously change the character of the building. We have followed handicapped guidelines in designing the restrooms in the basement. When contract documents are prepared, further decisions on access for the handicapped will have to be made. Two publications of the National Park Service, Accommodation of Handicapped Visitors at Historic Sites and The Impact of Accessibility and Historic Preservation Laws, Regulations and Policies on NPS Historic Sites: Analysis and Recommendations, should be consulted.

Our total cost estimate for moving and restoring Hamilton Grange is approximately 2.2 million dollars. The cost would be at least \$100,000 greater--and quite probably more--if the porch of St. Luke's cannot be removed. The total cost would also be greater if the street had to be plated. This cost could also be noticeably lower if some changes were made in the specifications (a substitute for imported brownstone, for example).

We realize that there is a significant problem with the interpretation of the Grange on its present site. However, the Grange has been on its current site almost as long as it was on its original site before it was moved in the 1880's. If it is going to be moved again it should be because there is a new location that would allow it ample space. We would suggest, for example, that the situation would be considerably better if the study site were enlarged to take in all of the block on which it sits. There would then be enough space so that the building could be somewhat isolated from its surroundings by landscaping and would not seem as crowded.

Thus, although it would be possible to move the Grange to the study site, we suggest that the Grange not be moved to this site in its present configuration. Other sites should be evaluated to see if it is not possible to find one that is more suitable. If such a site cannot be found within a reasonable distance (preferably, of course, on land within the boundaries of the original Hamilton estate), we suggest that the Grange remain in its present location and be restored as fully as possible there.

The sketches accompanying our analysis are located at the end of the report and are referenced in the right margin (e.g. S.1, S.20).

SELECTION OF METHOD FOR MOVE

The Hamilton Grange has already been moved once, and it will be possible to move it again without any serious damage. Because conditions have changed since it was first moved, there are some limitations to the ways and methods that can be used to move the structure again--limitations that will require extra care in both the preparation for and actual moving of the building and will increase the cost of the move. When the building was moved in 1888-89, the basement was left behind and new lower floors were constructed. As these lower floors are not part of the original structure, the client has stipulated that they remain and that a new basement and cellar be erected on the proposed site to support the portion (two stories and attic) that is to be moved.

The greatest problem that will be faced in moving the Grange a second time is space limitation. Because the building is wedged between two structures and because the porch of St. Luke's church projects in front of it and the body of St. Luke's church projects behind it, the Grange can not simply be moved towards the east or the west. In addition, the porches will have to be dismantled and moved out of the way before the main block of the building is moved.

There are three possible feasible methods for moving the Hamilton Grange. The first possible method--one that was advocated by the 1964 Bevin restoration drawings and specifications--is to cut the structure in half and move each half separately.

If this method is chosen, it would first be necessary to brace both halves of the structure near the proposed cut. Then the building would have to be cut in half. This procedure is complicated enough in a simple wood frame structure and would be considerably more difficult in the Grange because the brick nogging would have to be removed from the stud spaces where the cuts were made and some of the plaster installed as sound deadening between the floor and the ceiling below would have to be removed as well. The

steel required to support the building for the move would then be installed under each half: the cross steel, the track steel, and the dollies. The south half of the building could then be moved south about two feet. The north half could first be moved south about one foot to allow some clearance between it and the apartment building and then be moved off the site to the west to be taken to the new site. The other portion of the building could then be moved north far enough to clear the porch of St. Luke's church and then moved to the new site. With both halves of the building in their proper positions on the new site, the cellar and basement walls would be built up under the sills, the steel and dollies removed, and the two halves of the building rejoined. At every step of the move from the time the building was cut in half until the two halves were rejoined it would be necessary to securely protect both halves from the weather. Although this method would allow the building to be moved without disturbing the porch of St. Luke's church, and it will probably be the method required if that is the primary consideration, there are numerous reasons for choosing another method if possible.

Cutting the Grange in half would completely destroy both its aesthetic and its structural integrity. The skin of the structure would be cut—a situation not serious in the case of the roof which is to be replaced anyway but certainly more serious for the future appearance of the siding. The width of the sawcut would have to be filled when the halves were joined, and it would be hard to conceal the continuous joint. More importantly, however, the structural framing would be cut. It would be necessary to saw through the large timbers of the roof framing, the sills and the plates, and the joists the whole way across the first, second, and attic floors. When the halves were reunited, it would be necessary to join each of these members with either a wood scarf joint (using an additional member to join the two original ones) bonded with an epoxy adhesive or with metal plates and mechanical fasteners (or a combination of the two) so that each joint would be at least as strong as the rest of the member. No matter which method of fastening was chosen, the joints would be time consuming and expensive. They would not cause any major problems in the attic where

the structure is exposed, but they would require major disruptions in the ceilings and floors. In addition to the fact that the ceilings would have to be cut and the floors either cut or removed when the building is divided (and, as previously mentioned, a portion of the two-inch layer of brown plaster removed), the necessity of splicing the joists will require either that the floor be removed or that the plaster and the lath be removed from the ceilings for a distance of about 2'-0" at each splice.

Thus, cutting the building in half and splicing it together again is a complicated and time consuming procedure. Given enough time, money, and trained craftsmen, the permanent visual consequences of this method would be minimal. Much original material would have been lost in the process, however.

The second possible method for moving the building is to dismantle temporarily the north portion of the porch on St. Luke's church, install the supporting structure and dollies, move the building in one piece to the new site, and replace the porch on the church. This method is certainly preferable to the former as far as the integrity of the Grange is concerned and moving the building would be relatively easy. The major problem, of course, with this solution is the need to dismantle and reassemble the portion of the porch on St. Luke's church—a beautiful brownstone structure designed by Robert E. Robertson in 1892--that projects in front of the Grange. The 1924 deed transferring the Grange from the church to the American Scenic and Historic Preservation Society allows the porch to be removed if required. The congregation would prefer the porch was not removed. In addition, such details of the porch as the fine joints, the delicate moldings and the three-dimensional arch indicate that it would be hard to remove the blocks and replace them without damage.

If the decision to remove and replace the north portion of the porch is made, the first requirement would be complete graphic documentation of the existing situation through accurate measured drawings and rectified photographs. Then the roof would have to be removed, the individual blocks of

S.6,7

stone numbered, and an armature erected to support the blocks as those above were removed. After the blocks have been carefully removed and the mortar has been cleaned off, the stone will have to be stored on the rear of the Grange site with proper protection. When the column bases have been removed, the floor of the porch will have to be planked over. As soon as the building has been moved, the column bases must be set, the shafts placed, an armature erected, the arches and the wall above laid, and the porch reroofed. Any damaged stone will have to be replaced, and if the stones of the section that has been replaced have been rubbed or damaged so that the surface is gone and the color has changed, it may be necessary to clean the entire facade of the church.

The third alternative for moving the Grange is to remove only the roof of the northern end of the porch on St. Luke's church (an element much easier to replace than the stone of the porch itself), to protect the porch with wood cribbing around it and steel beams over it, and then to raise the building on cribbing above the level of the porch, move it over the porch, and lower it for the move to the new site. Although this method would still require some work on the porch of the church, the effect would be minor compared to the radical surgery required by the second alternative. This third alternative for moving the Grange should not cause any more damage to the original fabric of Alexander Hamilton's house than would the second alternative because the building would have to be jacked up for the move in any case (so that the sill at the first floor is raised to 11' above the ground) and then lowered when it is in place.

S.8

One complication that will occur in both the second and third alternatives is the fact that each of the steel sections forming the cross steel will have to be inserted into the building in two pieces and welded together in place because there is no room to insert the steel from the north or the south. This necessity will increase both the cost and the time required.

Because the first method of moving Hamilton Grange would severely damage much original fabric and the total cost of

the move by the third alternative is estimated to cost well over \$100,000 more than moving it by the second method, we recommend that, if possible, the Grange be moved by the second method—that requiring the removal and replacement of the northern portion of the porch of St. Luke's Episcopal Church. We have been assured that the work on the porch of the church would not be difficult. Our masonry consultant considered it a "nice" job—an attitude reflected in his quotation—and assured us that it would be possible to do the work without damage to the porch. He also stated that he was sure that it would not be necessary to clean the building. Thus, we have based our moving procedure and calculations on the assumption that Hamilton Grange will be moved by method number two. The supporting structure for the move and the procedure of move once the building was in the street, of course, would be the same for method number three.

STRUCTURAL INTEGRITY

The current draft of the Historic Structure Report on the Hamilton Grange in the section entitled "Settlement Analysis" reports that settlement of the bearing walls in the cellar since the building was moved "has created fairly severe problems in the internal framing system." The report lists the worst case as being in the first interior partition south of the north wall, particularly in the area between the two chimneys and especially on the second floor. A current structural inspection of the existing house revealed that certain settlements of the interior bearing partitions have occurred in the past especially in this area. There are fairly large racking deformations at the door jambs, and the floors exhibit a noticeable slope.

It also appears from the current inspection that the movements have been stabilized. There do not seem to be any fresh cracks in the plaster. The steel beam added at the cellar ceiling is in tight contact with the wood joists above indicating that it is functioning as a load-carrying member.

Movements in this area between the chimneys have been felt all the way up the building. The Historic Structure Report notes that "this settlement ultimately caused the bottom chords of the attic trusses to separate from the rest of the truss structure." The report continues with an analytical comment that the failure of the roof structure to act as a truss caused the bottom chord to function as a beam, thereby causing a large sag and ensuing loading of plates in the bearing walls below.

S.9

Current observations would seem to indicate a somewhat different interpretation of the causes and effects. In the first place, it does not appear that the attic structure is a truss, but it is rather a braced frame of heavy timbers. There are major girders in the attic floor, posts to the roof, and another row of major girders just below the rafters. Diagonal knee braces have been let into the roof girders and the vertical posts. There is no continuous

system of diagonal or vertical web members which would allow the roof and attic floor girders to function as the top and bottom chords of a truss.

There is clearly a severe separation between several members, particularly at the northwest intersection of the interior bearing girders. It does not, however, appear that this separation has induced loads in the bearing partitions below, but rather the opposite--that settlements in the lower bearing partitions have caused the separation of the framing members in the attic. It would appear that, if the movements are stabilized, the separation of framing members in the attic can be repaired, and the structure can continue to function satisfactorily.

The simplest method of correcting the separation of members in the attic would be to block and shim tightly between existing members that have separated. Then steel straps would be lag-bolted across the former separations to hold all members in place. This technique assumes that there will be no attempt to conceal methods of structural stabilization. The attic, if the roof is returned to its original configuration, will have a maximum ceiling height of about four feet and will certainly not be open for public interpretation. Indeed, there are already many supplementary framing members which have been introduced over the years and are clearly not original.

S.9

After the structural members in the attic have been blocked, shimmed, and strapped, it is felt that no other special stabilization, reinforcing, or other structural repairs will be required to make the house safe for moving. It should be able to be moved in one piece with no further precautions required. No cross bracing, cabling, bridging, blocking, or other structural intervention will be required because of the inherent stability and integrity of the existing building.

A final consideration is whether or not to attempt to remove the evidences of settlement and racking in the present floors and door frames. It is our consensus that no such attempt should be made. It seems consistent with the

character of a 175-year old structure that it might have had some settlement problems. This information might even become a part of future interpretation.

Any attempt to correct the settlement would require that plaster be removed prior to jacking up the floors. Thus, much original material would be lost. Furthermore, the success of jacking the floors is a very uncertain proposition. Structural elements do not always return to their original positions because often, after the original displacement, pieces of plaster or wood become lodged in these new spaces and serve as blocks. In order to restore floors to their original levels even more of the original fabric may have to be removed in order to clean out this debris that is in the way. One positive result of jacking the structure might be that the structural repairs in the attic could be somewhat more authentic. However, some new steel strapping might still be required if, after the building was jacked, evidence of fracture of tension members or pegs in mortise and tenon joints was revealed.

As stated above, we do not recommend any attempt to straighten the structure.

CONSTRUCTION WORK AFTER GRANGE HAS BEEN MOVED

After the moving contractor has located the Grange in its final position over the footings on its new site, he will have to crib under the cross steel and remove the track steel and the dollies. The cribbing must be carefully placed so that it does not interfere with the construction of the basement bearing walls. After the steel has been removed, the cellar and basement walls will have to be formed and poured to grade, and the 12" brick backup wall of the basement story laid to a level just below the sills of the Grange around the cross steel and the blocking which still support the structure. The small space between the top of the masonry wall and the sill will have to be densely packed with a rich, dry mixture of cement and sand. The lower two stories of the chimneys will also have to be laid, and the joint between the old and the new packed as described above. Then the steel and the cribbing should be removed, and the portions of the walls that were left open around the steel should be filled.

S.20

S.21

As soon as the moving contractor has left the site, restoration and new construction can begin on both the interior and exterior of the building. The complete scope of this work will be detailed and specified in the construction documents produced as part of the comprehensive architectural services. The preliminary scope has been compiled from the 1964 Bevin drawings and specifications and the changes required by the Historic Structure Report now in progress.

On the exterior, foundations and piers will have to be poured for the front and rear porticoes and the side piazzas. The footings should be deep enough to rest on rock or undisturbed earth, and the reinforced piers should be poured to a level just below grade to receive the sandstone bearing blocks (reused where possible and new where required). Also at this time it will be necessary to carefully waterproof the exteriors of the cellar and basement walls. We recommend two coats of Thoroseal covered with a bituminous coating. Because we believe that the ground below is rock that will hold water, we recommend instal-

lation of footing drains piped to leeching rings at least twenty feet from the structure. After this work is completed and all of the new utility lines have been installed, the entire site should be filled with bank run gravel to a level one foot below finished grade over most of the site and six inches below finished grade where the bluestone walks are to be laid. The brownstone facing of the basement story and the brownstone bearing blocks can be laid at this time.

The side piazzas should then be reerected in an order the reverse of that in which they were dismantled. They should be restored and reroofed. The front and rear entrances should then be removed from the side of the Grange and installed in their proper positions. The front and rear entrance porches and steps can then be constructed.

While this work is underway the roof of the main portion of the Grange can be returned to its original configuration. It will first be necessary to carefully remove the existing roof and the supporting structure for the portion that is to be replaced and to remove all unneeded material from the site. Then new roof girders can be installed where evidence indicates that they were originally positioned, new joists can be supported between them, and new sheathing can be laid over the structure. Finally, a new lead-coated copper roof can be laid on the upper portion and new cedar shingles on the lower--all joints being carefully flashed. At this time the false chimneys should be completely restored replacing sheathing and exterior covering as necessary. The new balustrades should be installed on the roof, the piazza roofs, and the entrance porticoes. When the flat part of the main roof and the roofs of the side porches have been completed, they can be painted. All other exterior patching and repairs should then be completed, and the building painted.

S.37

The work on the interior of the Grange can proceed at the same time as that on the exterior. The cellar and basement are new. The plumbing, heating, electrical, and finishing work in these stories will have to be carefully coordinated. The National Park Service has requested that, instead of

reconstructing the basement as it is thought to have existed, we should plan for public facilities and a caretaker's apartment. Our proposal is shown on the sketch. We suggest that the brickwork for the fireplaces on that floor be laid so that the basement could be interpreted in the future if required. In order to facilitate the layout of the rooms, we suggest that some of the bearing walls present in the original be replaced by steel beams.

S.25

The scope of work for the restoration of the upper floors has been shown on the sketches as determined from the Bevin drawings and the Historic Structure Report. In restoring the main portion of the structure, all demolition work should be done first—mantels removed, unsound plaster taken down, and the attic stairs relocated. The main stairway may be used as long as possible before being removed for the new one. The scope of work indicates that 100 percent of the ceiling plaster is to be replaced as Bevin suggested for estimating purposes. It is entirely possible that it would not be necessary to replace all of the plaster. Some of it may well be sound, and in order to preserve original material, it may be possible to consolidate some of the plaster now in place. It is important that all heating and electrical work be installed before the plaster is replaced.

S.24-36

After the plaster work is completed, the finish work should be done and the inside of the Grange painted.

PLUMBING, MECHANICAL, AND ELECTRICAL SYSTEMS

PLUMBING

A complete new plumbing system should be installed for the two public restrooms and the bathroom and kitchen of the caretaker's apartment on the basement level. The system should include the gas-fired domestic water heater removed from the present location and new gas range, lavatories, waterclosets, urinal, bathtub, and water cooler as indicated in the sketch. The system must also include all required piping and floor drains and sump pump in the boiler room. Because all the plumbing is in the basement level, it will be easy to run the pipes in the cellar.

S.25

MECHANICAL

The house is currently heated by a gas-fired boiler of approximately 225,000 BTU/H capacity. Steam is distributed to the house through a piping system feeding radiators on all floors.

The boiler appears to be in good condition and appears to be operating satisfactorily. With proper maintenance, the unit could be expected to provide up to fifteen years additional service. However, because our calculations show necessity for greater capacity, we recommend that a totally new system be installed.

A heating load calculation for the building was prepared based on maintaining the space at 60 degrees Fahrenheit against an outside temperature of 0 degrees Fahrenheit and a 15 MPH wind. The following "u" values were used:

Glass	-	1.13	BTU/H - Degrees F.Sq.Ft.
Wall	-	0.4	BTU/H - Degrees F.Sq.Ft.
Roof	-	0.5	BTU/H - Degrees F.Sq.Ft.
Infiltration	-	1.85	CFM/Lin.Ft. of crack

A high infiltration factor was used to include some infiltration through the building fabric.

The heating load calculation using the above values results in a total heating load for the building of 350,000 BTU/H at design conditions.

Based on the load calculations and field survey, it is our recommendation that a heating system as described below be adopted for the renovation of the house.

S.38-42

A new cast iron hot water boiler with a net capacity of 350,000 BTU/H should be installed in the mechanical equipment room in the cellar. Hot water should be piped to four air handling units with duct-mounted hot water coils—two fan coil units in the mechanical equipment room and two fan coil units in the attic as indicated in the sketches. These attic air handling units are 1'-11" high by 2'-1" high by 1'-8" long and weigh approximately 150 pounds each; thus the structural members supporting the units in the attic should be able to sustain the load.

S.38,42

Warm air should be distributed to the spaces through runs of ductwork supplying new floor or low wall diffusers and grills located in the fireplaces.

S.48-49

All ductwork and piping should be concealed in attic spaces, chimneys, and closets as shown on sketches. New air diffusers should be blended in with fireplace openings where possible to minimize visual effect.

The system as designed will allow separate temperature control for the basement and the two floors of the historic interior so that it will be possible to save energy when the upper floors are unoccupied.

The system outlined above could easily be provided with humidifiers to maintain a relative humidity, not to exceed 30 to 35 percent, in the space during the heating season. Dehumidification during the summer months, if justified, would require the installation of cooling coils in the air handling units and condensing units, either air cooled,

located outdoors, or water cooled, located in the building. We recommend humidification to between 30 and 35 percent relative humidity in the winter; we do not believe dehumidification in the summer is necessary or advisable.

Humidification would be accomplished by a hot water jet humidifier installed in closet space at an approximate cost of \$500 per unit with a maximum of six units. Humidification will aid in preserving the wood finish and furniture, but it should be pointed out that, with single glass, sweating on windows will occur. Scheduling the relative humidity according to outdoor conditions will help alleviate this problem.

ELECTRICAL

New electrical service to the building is required including a complete rewiring of the interior. The new service should be 220 volts at 150 amperes to a circuit breaker panel with a capacity of 30 breakers. The new interior wiring should include 110 volt circuits on the basement level and for convenience outlets in the upper floors and low voltage lighting circuits on the first and second floors.

For additional security protection five exterior lighting fixtures should be installed around the building--two in front and one on each side and in the rear. In addition a fixture to light the parking lot should be mounted on the building to the south.

Suggested placement of fixtures, switches, and receptacles is shown on the sketches.

S.43-47

Appendix M

Molding Analysis

The moldings used at the Grange demonstrate clearly John McComb, Jr.'s, subtle but imaginative approach to ornamentation. The type of moldings used in each room varies according to the function and relative importance of the room. This, of course, is not unusual. What is unusual is the large number of molding types. For example, there are at least 10 different types of original doorway and window casings alone. The situation is further complicated by still other types of moldings introduced during various remodelings, chiefly those of c. 1850 and 1888-1889. In general, the original moldings have been shaped from a single piece of wood by the use of several molding planes. The later moldings have been built up of various pieces, each milled to have one profile element only. All moldings drawn here are shown full-size, unless noted otherwise.

Casings. Originally, doorways and windows in any given room seem to have displayed the same casing profile. Nearly all of the nonconforming moldings present today stem from later remodelings. In all but the simplest rooms, the side casing members of the double-hung windows extend down to the floor, creating the illusion of triple-hung windows. The area beneath the windows, between the side members, was plastered to form a sort of "panel" (Ill. 18). This treatment was not restricted to any one molding type: it was done in rooms with ornate casings, and in rooms with relatively simple casings.

In order to help comprehend the myriad of Grange moldings, a somewhat arbitrary classification system based upon stylistic features was devised. The original moldings have been divided into four major types (A-D), in descending order of ornateness. Each type actually consists of two to three variations upon a common theme. There is also a mid 19th-century type (E), and a group of profiles dating from 1888-1889. Most of the early moldings are drawn here. Two entire groups of original moldings have been left out, however. The first group consists of the moldings of the tripartite window of the second-floor front hall, which is well-documented in Appendix G, sheet eight, and Appendix H, sheets 13-15. The second group includes the moldings of the arched doorways, extensively depicted in Appendix G, sheets 11-12, and Appendix H, sheets 13-15.

CASING TYPE A: two fasciae connected by a molded joint, unusual edge molding

Fancier version: "talon" edge molding

east octagon room, doorways and windows
first-floor northeast room, doorway
and windows

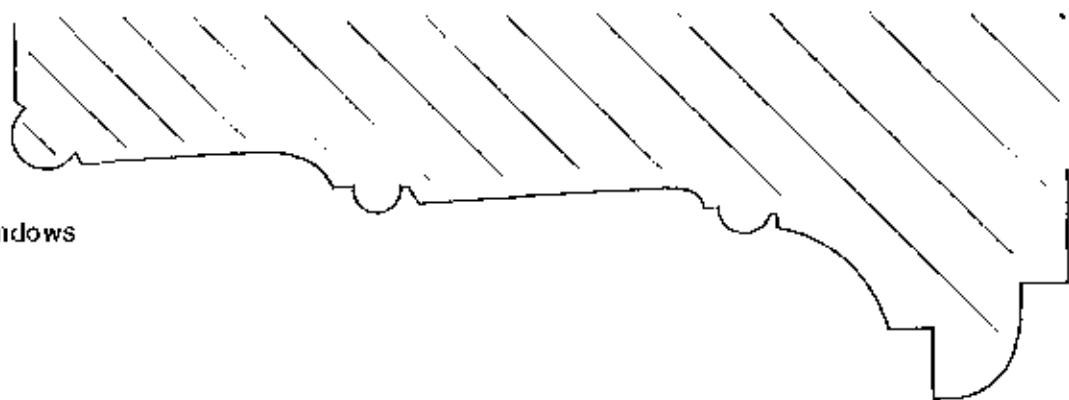

Simpler version: "ball" edge molding

west octagon room, doorways and
windows

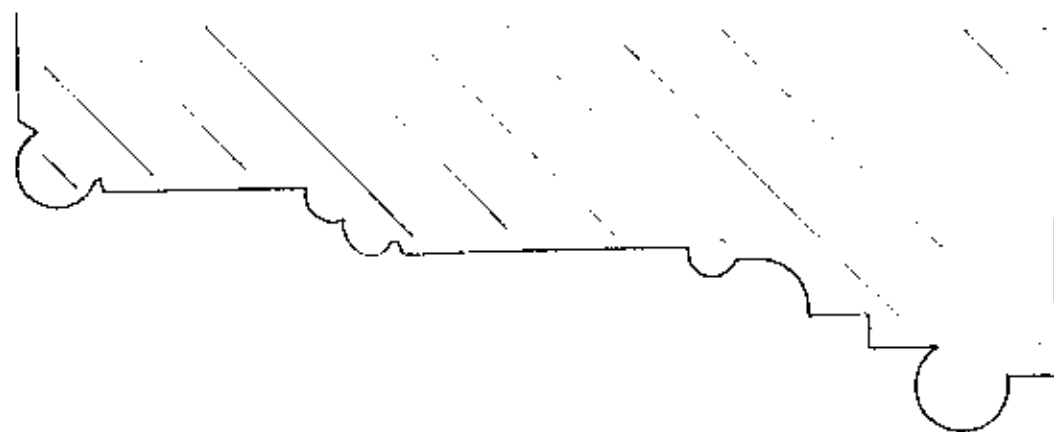

CASING TYPE B: two fasciae connected by a molded joint, standard edge molding

Fancier version: two additional "ridges"
in edge molding

front doorway
doorways within south apse

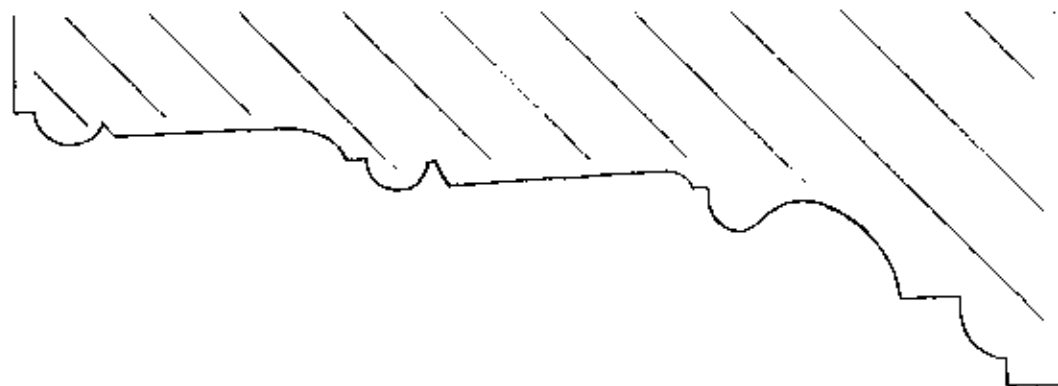

Simpler version: more sinuous edge
molding

first-floor stair hall, doorway to
southeast room (study)

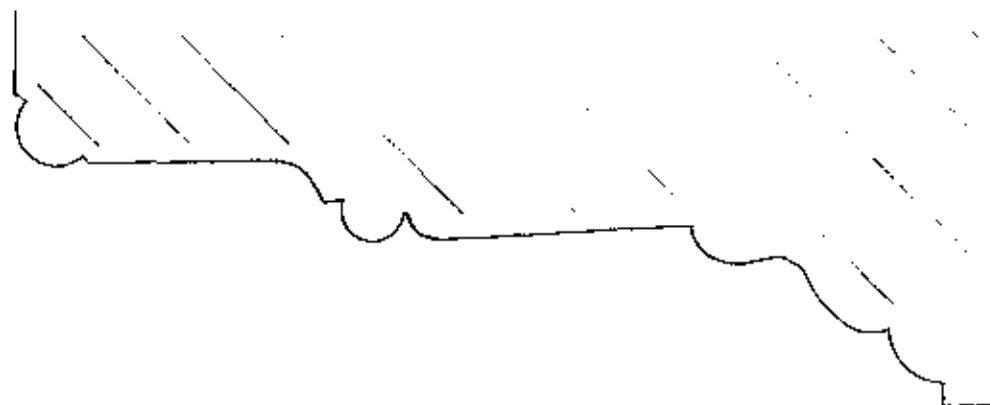

CASING TYPE C: quirked ogee and bead edge molding

Fancier version: two fasciae connected by
a molded joint

first-floor southeast room, doorway
and windows
first-floor north hall, window
second-floor north rooms, windows

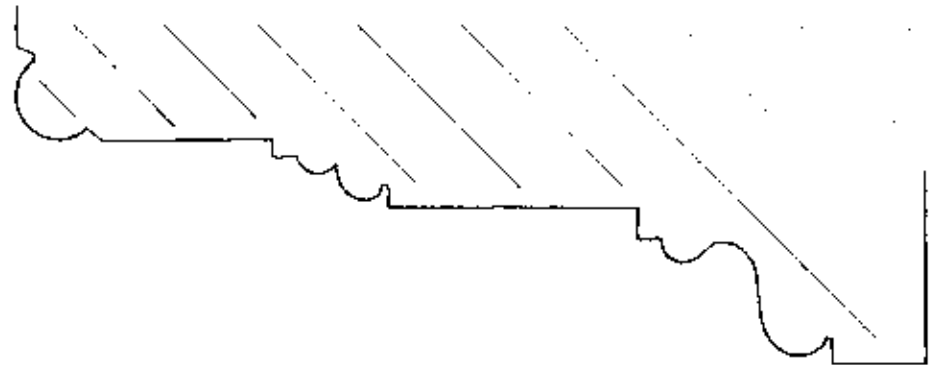

Simpler version: two fasciae connected by
an unmolded joint

second-floor southeast room, doorway
and windows

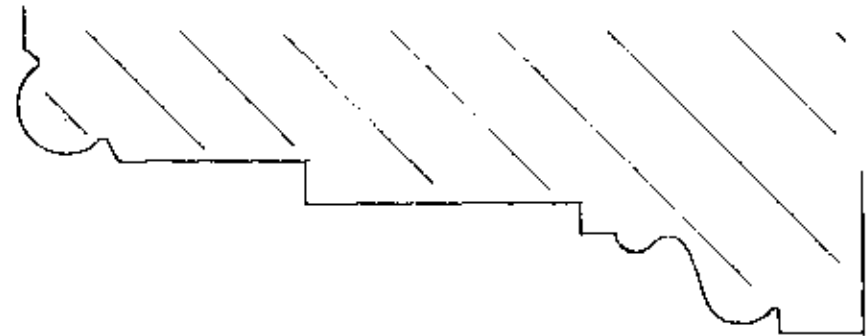

Simplest version: one fascia

original second-floor closet, doorway
and windows

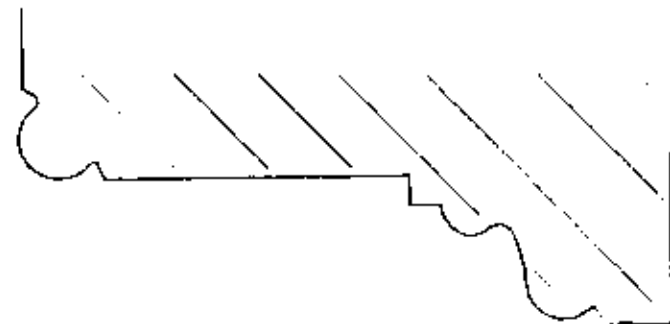

CASING TYPE D: torus in edge molding

Fancier version: two fasciae, molded joint,
two beads in edge molding (1810-1820)

second-floor north hall, doorways to
corner rooms and bathroom
second-floor north corner rooms,
doorways to hall
second-floor bathroom, doorway to hall
(has unmolded joint between fasciae)

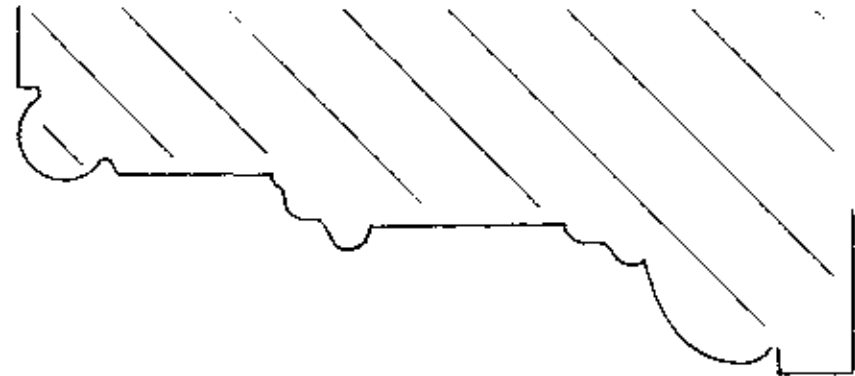

Simpler version: two fasciae, slightly molded
joint, one bead and ridge in edge
molding

first-floor northwest room, doorways and
windows
first-floor north hall, doorways
second-floor front hall, doorway to
southeast room
second-floor center hall, doorways
second-floor center rooms, doorways and
windows (except north window, east
room)

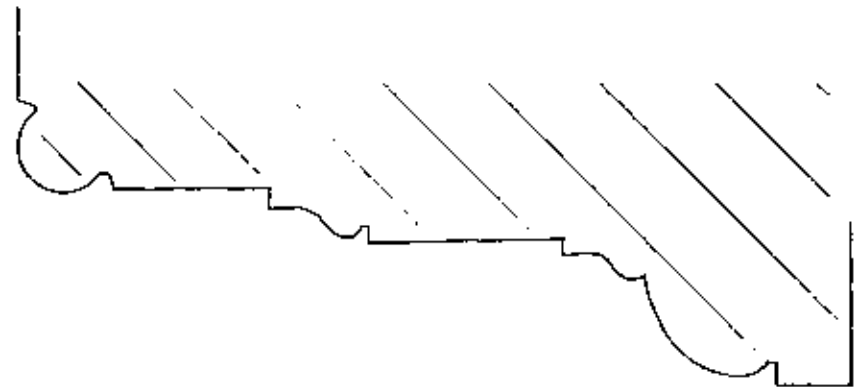

Simplest version: two fasciae, slightly molded
joint, one bead in edge molding

original stair hall
second-floor southwest room, south
window, top and east members
second-floor front hall, doorway to
southwest room (moved here from
original location within stair
hall)

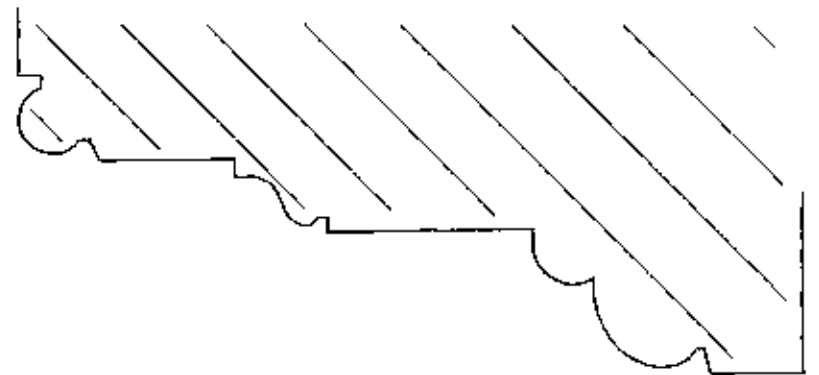

CASING TYPE E: two fasciae connected by a molded joint, shallow edge molding

One version only:

doorway between second-floor east
center room and northeast room,
both sides (c. 1850)

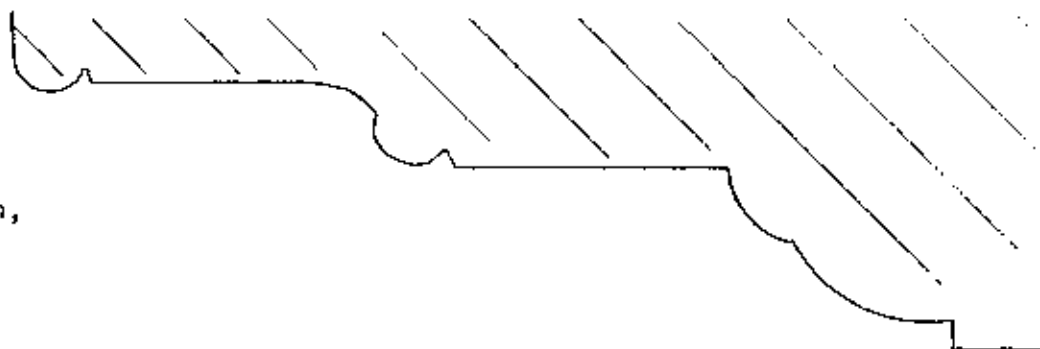

List of 1888-1889 Doorway/Window Casings
(not drawn)

1. First-floor entry hall, window (might be an original casing)
2. Second-floor southwest room, doorway to hall
3. Second-floor southwest room, south window, west member
4. Second-floor front hall, apron molding under tripartite window
5. Second-floor center hall, doorway to attic stair (no inside casing)
6. Second-floor east center room, doorway to closet, south member
7. Second-floor east center room, doorway to closet, inside casing
8. Second-floor northwest room, doorway to closet (no inside casing)

List of Nonhistoric, Undated Doorway/Window Casings
(not drawn)

1. Second-floor east center room, north window, edge molding

Baseboards. The Grange's original baseboard moldings are as diversified as its casings. As would be expected, the more ornate versions are found in the more important rooms. However, the "ranking" of rooms evident in the casing profiles differs somewhat from the "ranking" of rooms apparent in the baseboard moldings. Thus, a different combination of casings and baseboards is found in every room.

Again, a somewhat arbitrary classification system based on style has been used here to help clarify the large number of baseboard forms. At least four original types have been identified (A-D), and a fifth type (E) is probably original. A sixth type (F) consists of three moldings used in imitation of original baseboard moldings. A seventh type (G) was introduced during the remodeling of 1889. Five of the seven types have two versions.

The base moldings of the three arched doorways also vary, according to each arch's prominence. These are depicted in Appendix G, sheets 6, 11-12, and Appendix H, sheets 27 and 31.

BASEBOARD TYPE A: ogee and torus

Fancier version: two ridges
east octagon room



Simpler version: one ridge
first-floor stair hall
(original entry hall)



BASEBOARD TYPE B: two tori

Fancier version: a cavetto
between tori

west octagon room

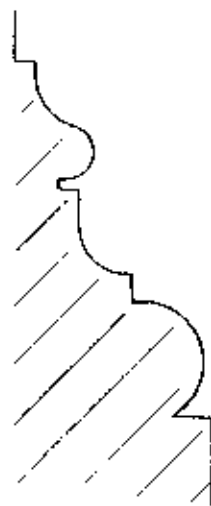

Simpler version: a ridge
between tori

south apse



BASEBOARD TYPE C: cavetto and torus

One version only: ridge between cavetto
and torus

first-floor north hall
first-floor northeast room
second-floor front hall
second-floor center hall
second-floor east center room,
attic stair-compartment walls
second-floor north rooms



BASEBOARD TYPE D: ogee

Fancier version: bead and ogee
north apse



Simpler version: no bead
first-floor southeast room
second-floor southeast room
second-floor center rooms



BASEBOARD TYPE E: ridge and torus

One version only:

first-floor northwest room



BASEBOARD TYPE F: imitations of original baseboards

Fancier version: pronounced ogee and torus,
two ridges above ogee
(imitates fancier Type A)

east octagon room, on either side
of mantel (c. 1885)

Simpler version: ogee, cavetto, torus
(imitates fancier Type B)

west octagon room, on either side
of mantel (c. 1885)

Simplest version: pronounced ogee and torus,
quirk below torus
(imitates fancier Type A)

east octagon room, west of
fireplace (date unknown)



BASEBOARD TYPE G: cavetto, torus, bead

Fancier version: bead below torus (c.-1889)

first-floor entry hall
up main staircase



Simpler version: no cavetto, bead above
torus (c.-1889)

first-floor stair hall, south wall
second-floor southwest room
second-floor southeast room, west
wall



Cornices. Judging by McComb's proposal of 1801, six of the eight cornice profiles found at the Grange today (A-F) are original. The seventh (G) dates to the 1810-1820 partitioning of the second-floor north room; the eighth (H) was introduced during the 1888-1889 remodeling.

Concerning the six original profiles, five of them were used in only one room each. (Although one is found in both second-floor north corner rooms, and in the adjacent bathroom and north hall, it is actually the single cornice remaining from the large north room once here.) The most elaborate profile is used twice, in the two octagon rooms. However, it should be remembered that the present form of the octagon rooms' cornice is the result of a modification of McComb's proposal. Therefore, it is possible that McComb had originally envisioned two different — if simpler — cornices for these rooms as well. In any case, enough variety exists among the profiles to suggest that those replica cornices that will be needed for the restored areas of the first floor should merely relate to — and not copy — the most appropriate original cornices.

The profile of the octagon rooms' cornice is unusually sculptural for the Federal period, but not unlike other original Grange cornices, especially those of the first-floor north hall and apse. The north apse's cornice resembles that found in the south apse: it has less projection and depth, but features two additional ridges in its upper section. The north hall's cornice resembles that of the north apse: it has less projection and one less ridge in its upper section, and it substitutes a cavetto for an ogee form at its base. The original cornice sections found in the second-floor north rooms are rather elaborate: they have the projection of the south apse's cornice, the upper two ridges of the north apse's cornice, the cavetto of the north hall's cornice, as well as four more ridges, two ovolos, another small cavetto, and a bead. The type of cornice found on the north-south partition walls here, added in 1810-1820, was made in imitation of the adjacent original cornice. The resemblance is exact in its upper section, but its middle and lower sections have less projection, and lack the smaller cavetto and bead.

CORNICE TYPE A: octagon rooms
(half size)

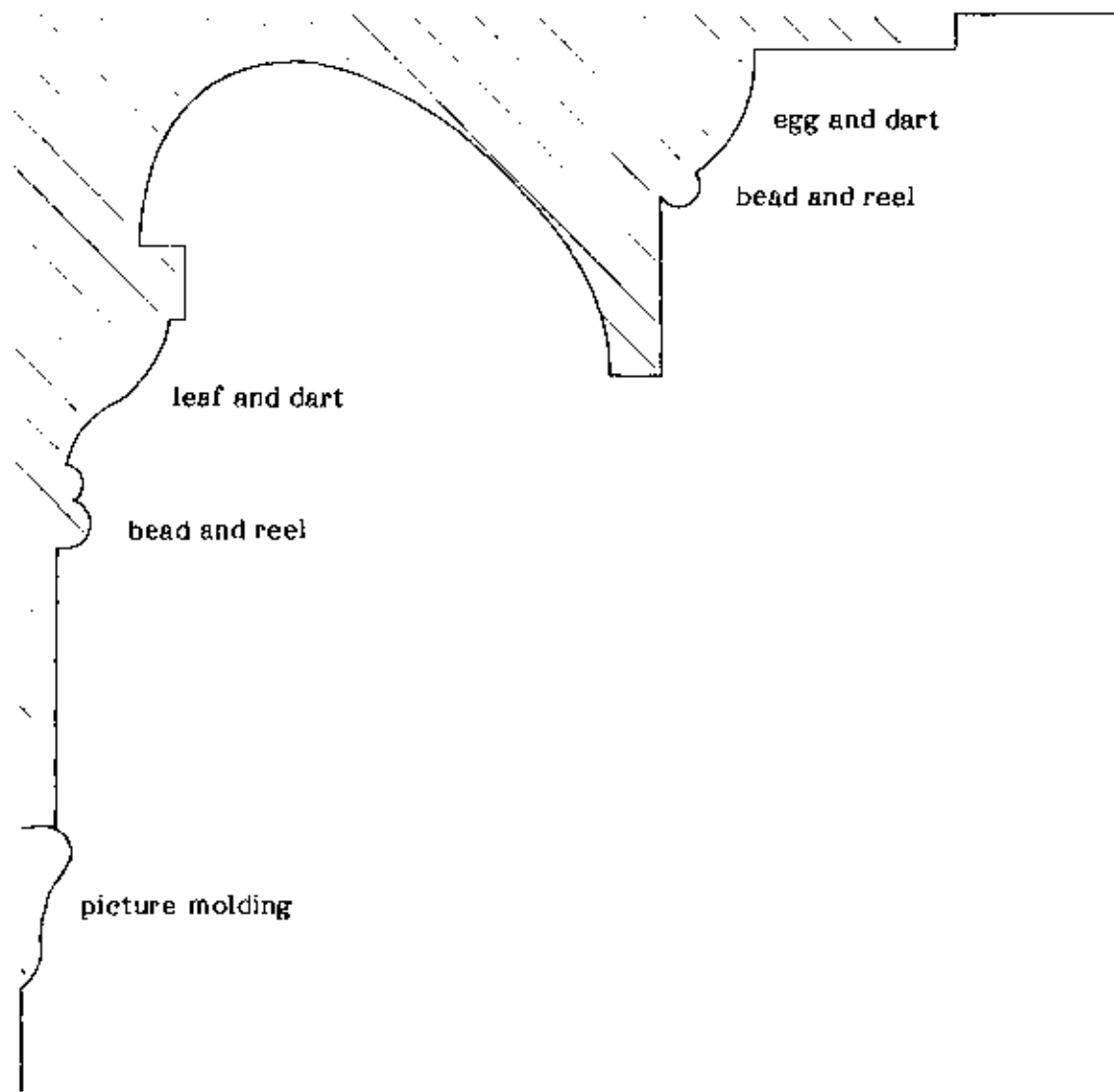

CORNICE TYPE B: south apse

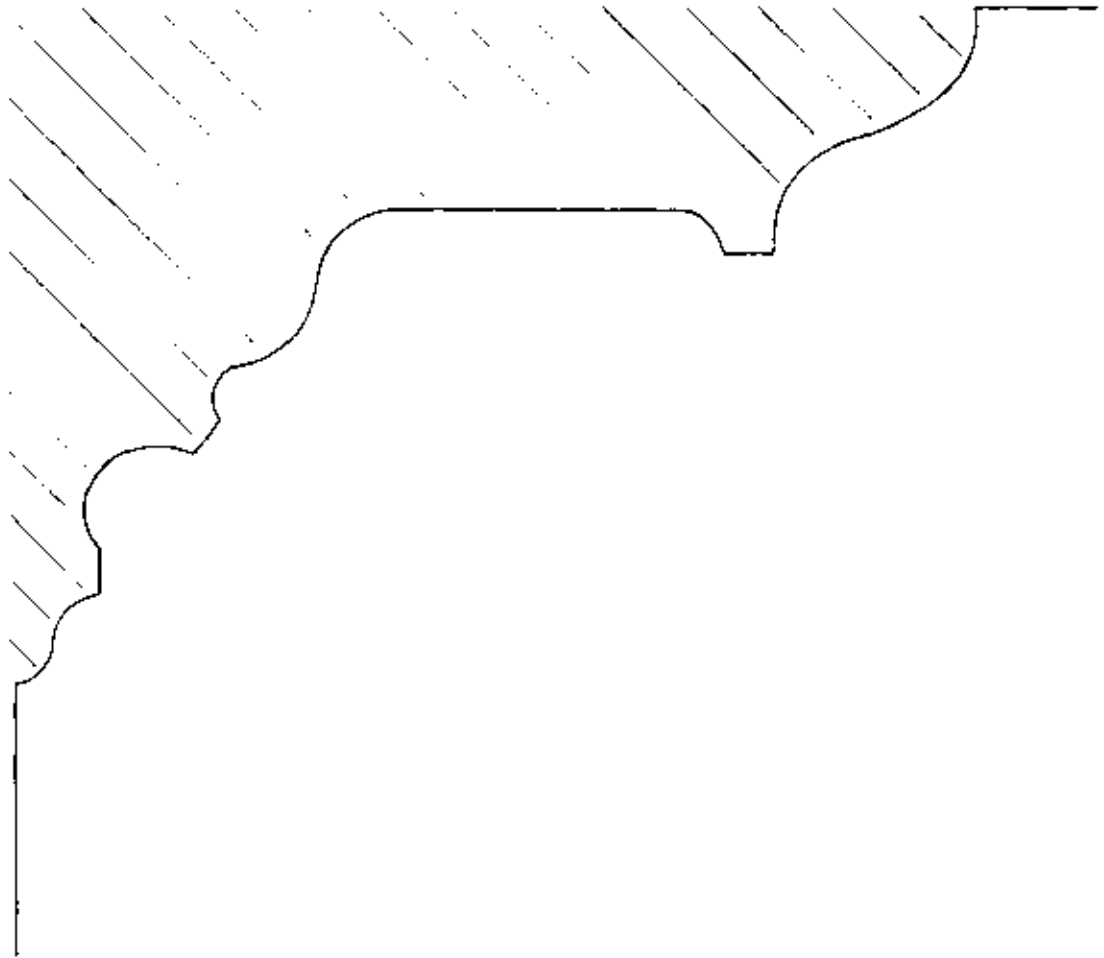

CORNICE TYPE C: first-floor southeast room

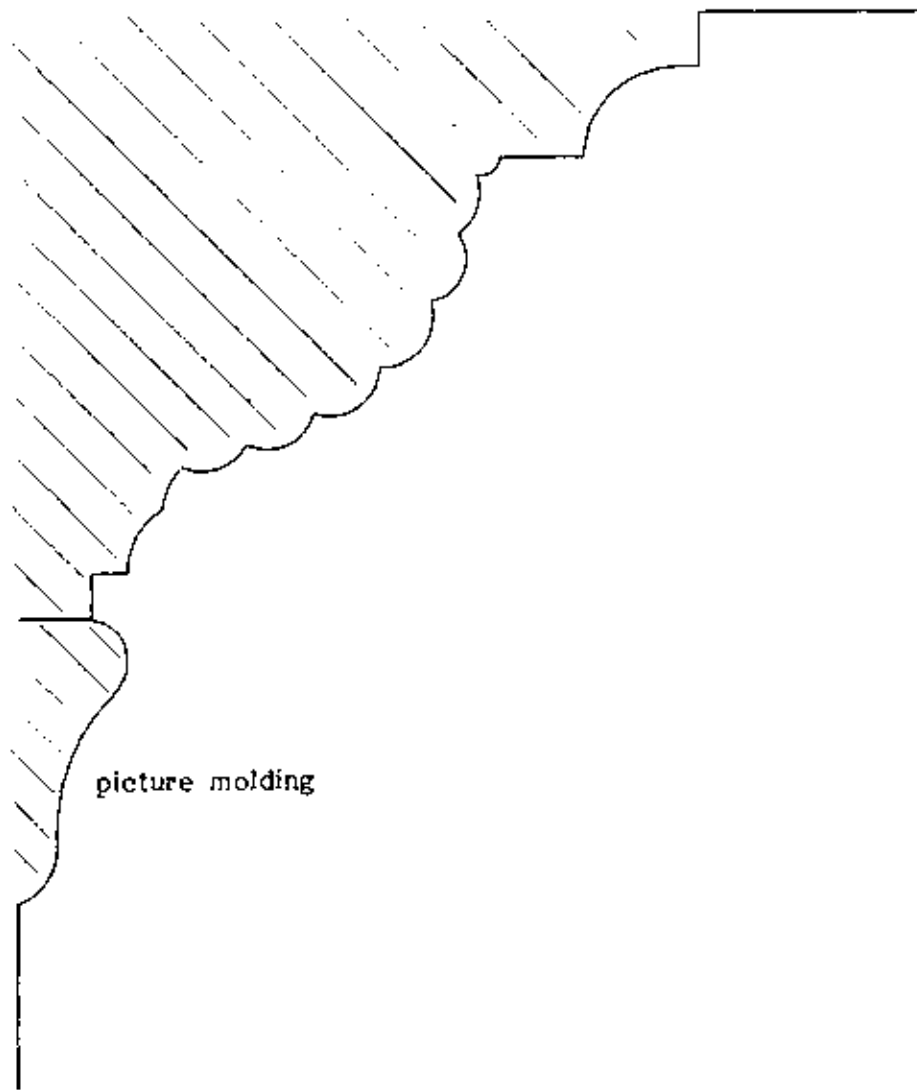

CORNICE TYPE D: north apse

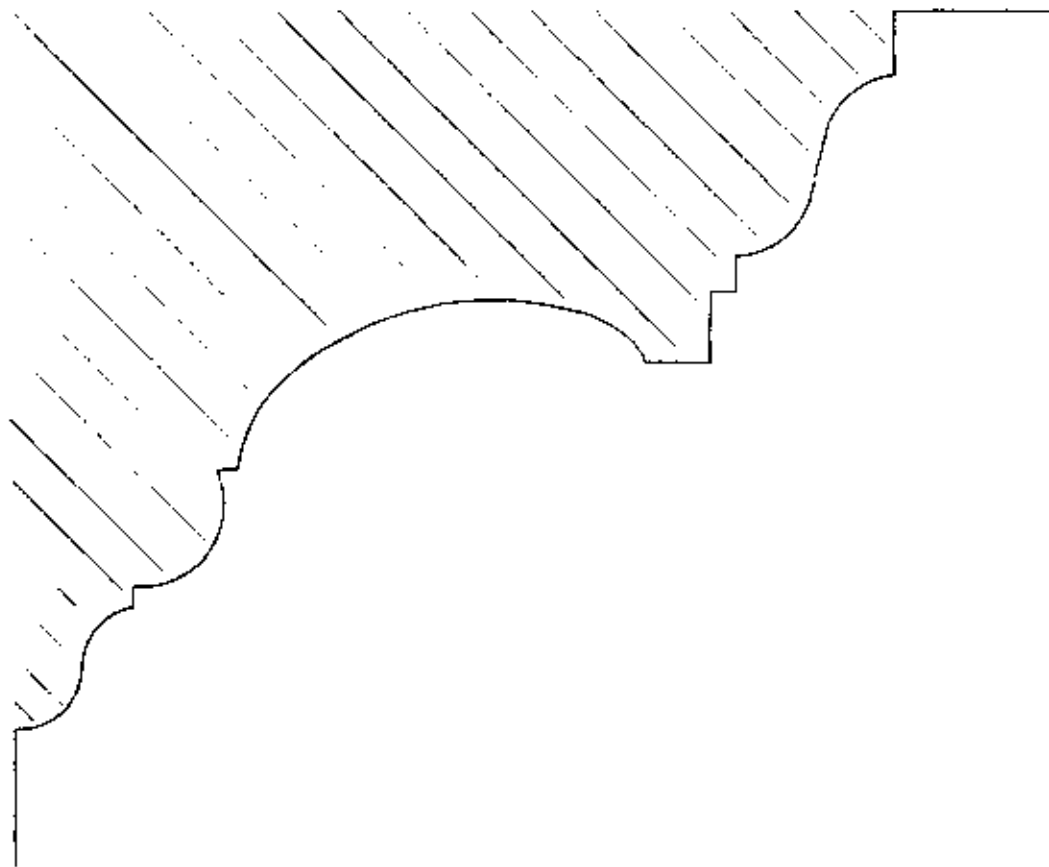

CORNICE TYPE E: first-floor north hall

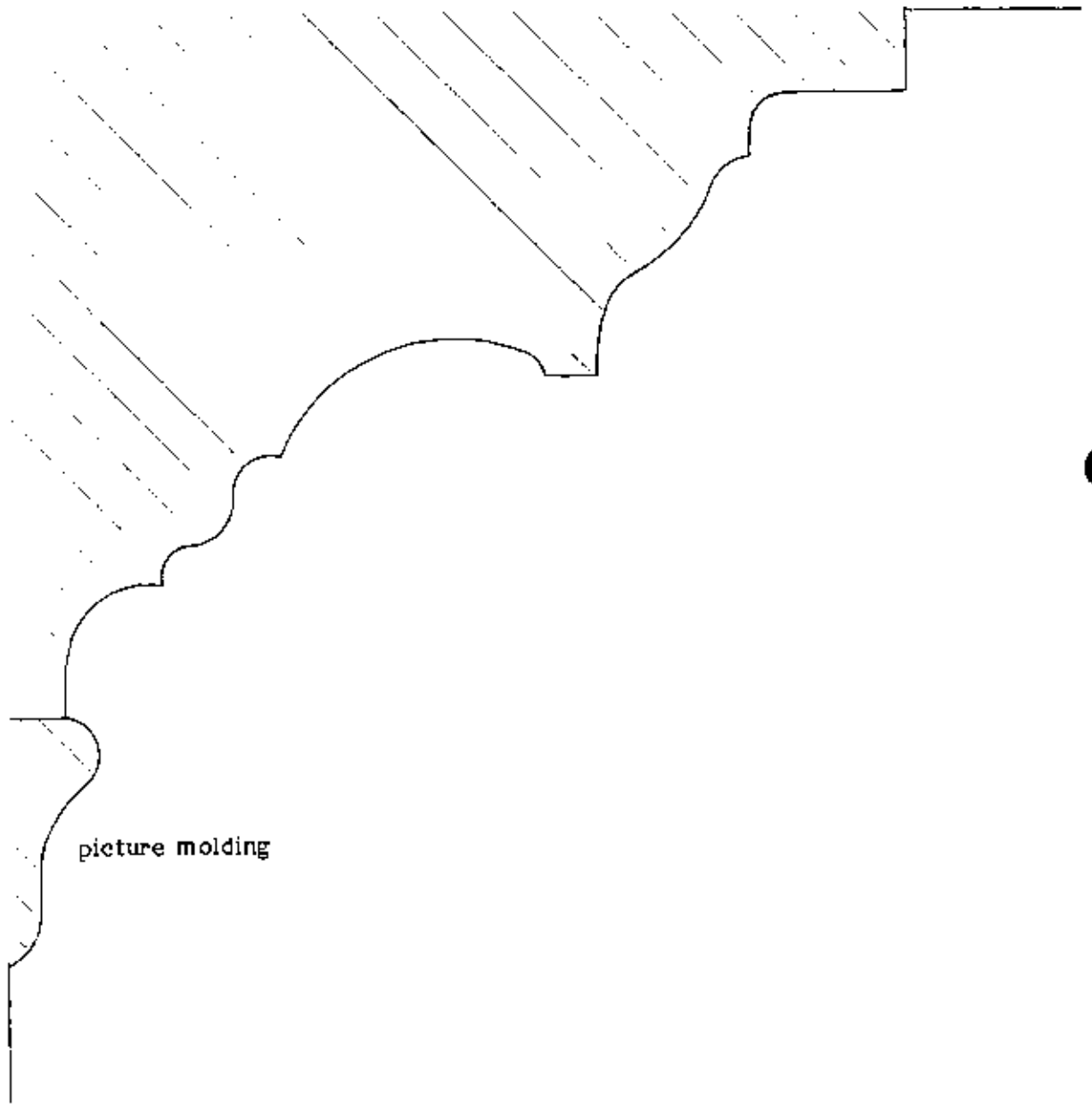

CORNICE TYPE F: second-floor north rooms

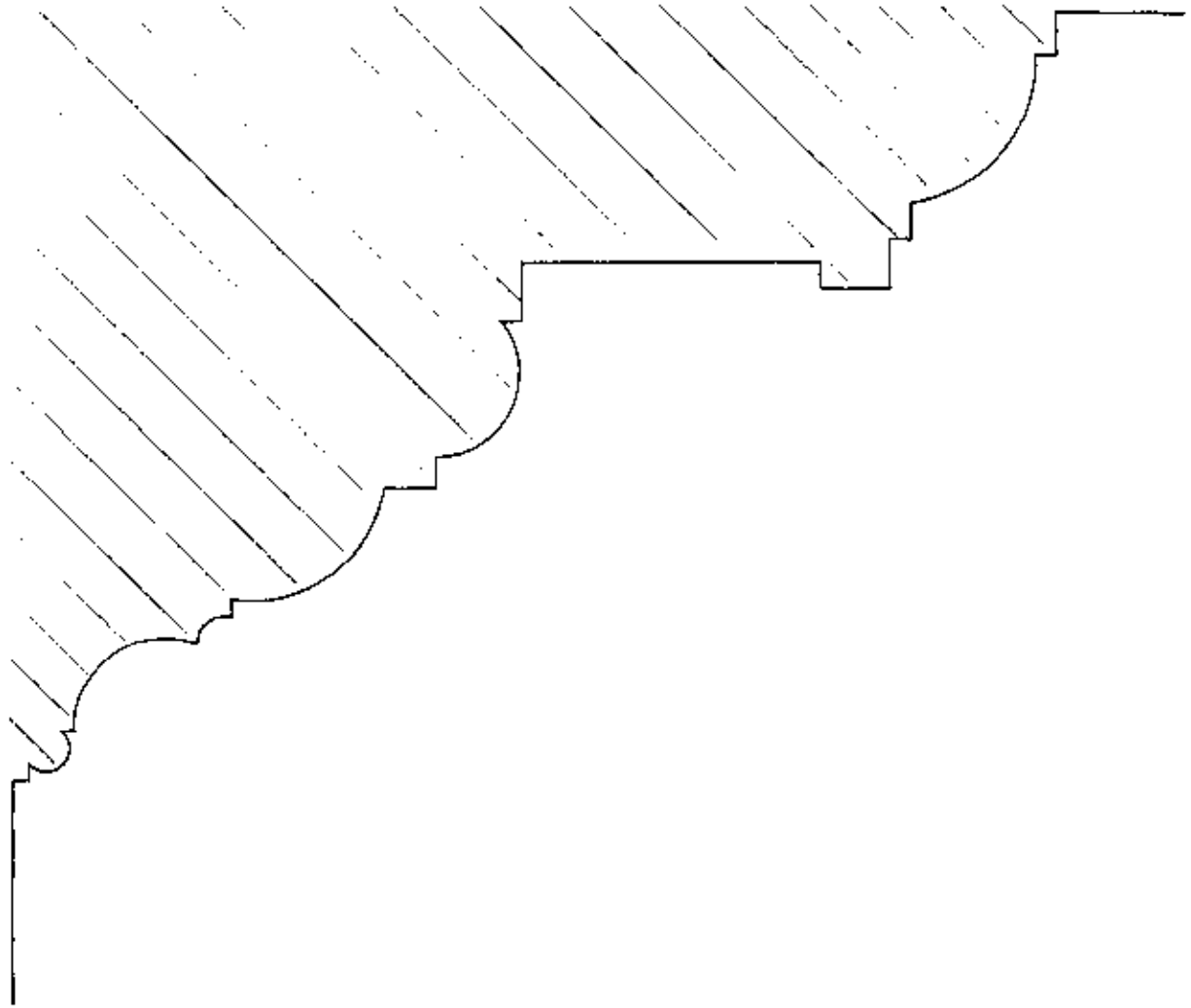

CORNICE TYPE G: second-floor north partitions
(1810-1820)

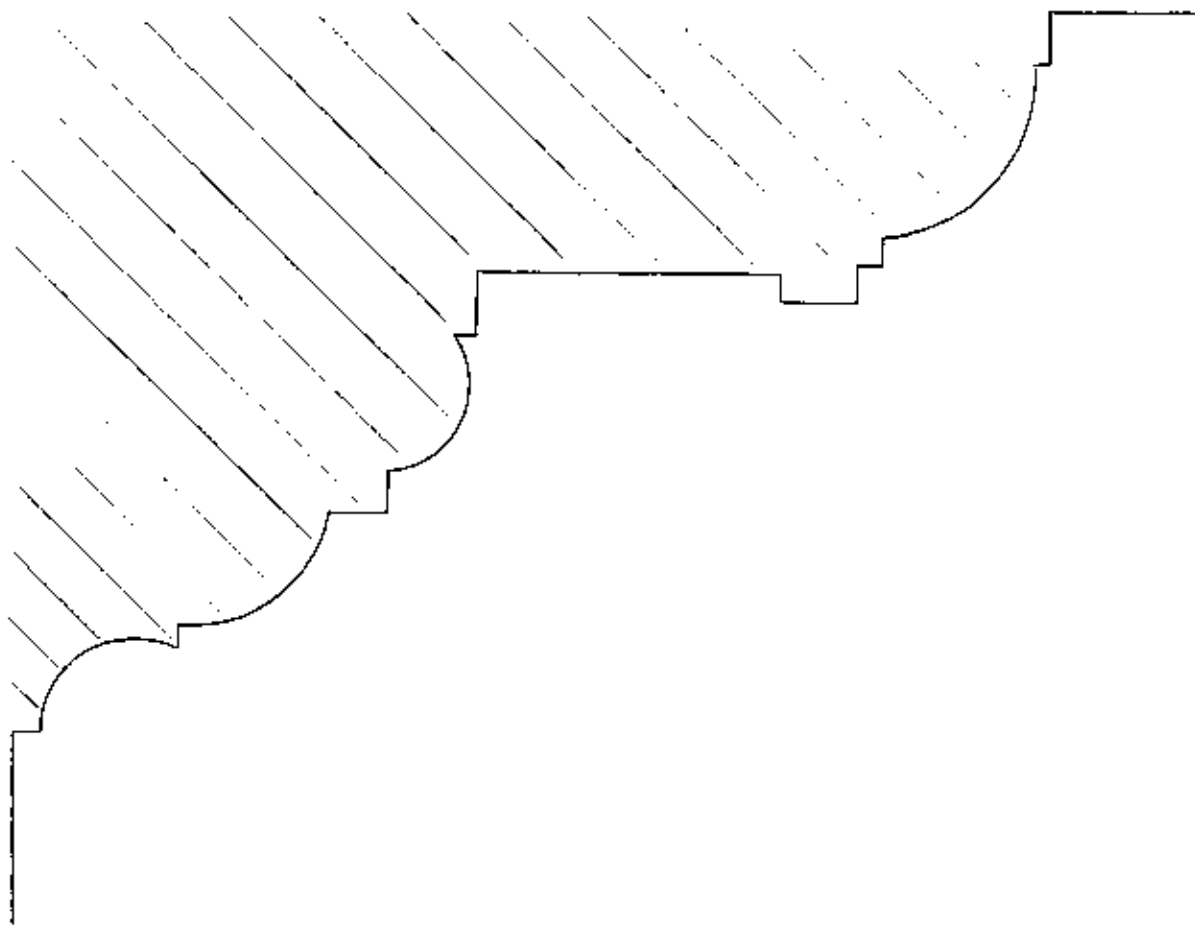

CORNICE TYPE H: entry and stair halls
(1889)

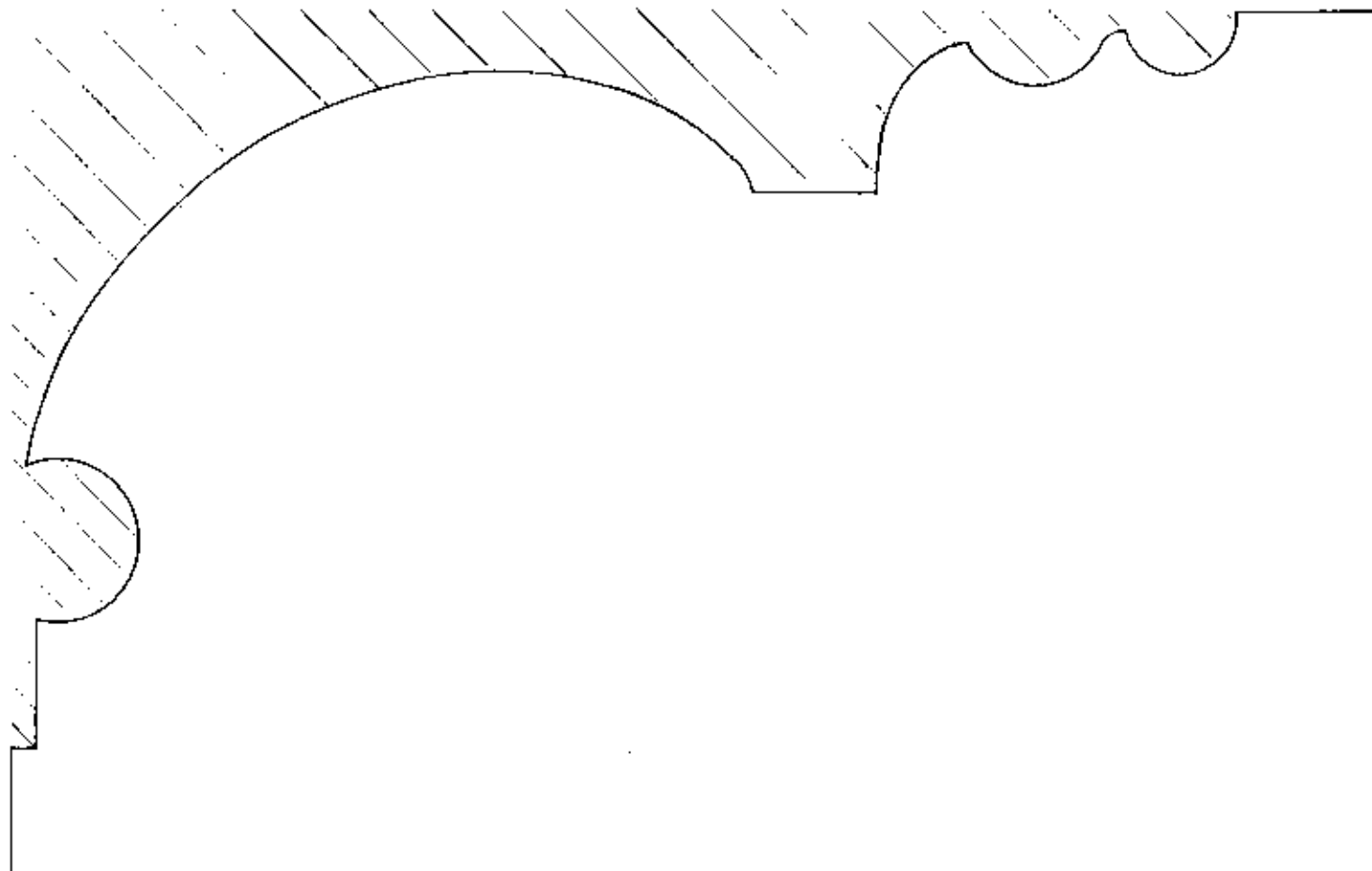

Door-Panel Moldings. A single, characteristically Federal panel-molding profile is found on all original doors, whether interior or exterior. The panel molding on the doors within the second-floor north-room partitions is considerably more complex than the original profile. This seems unusual, since it postdates the latter by only a few years, and since considerable pains were taken to have the doorways' casings match the adjacent original casings.

The panel molding of the door linking the second-floor east center room and the northeast room includes a Grecian ovolo, which indicates a roughly c.-1850 date. Its doorway's casing profile is compatible, if not similar. The panel moldings of the doors to the two second-floor closets also relate well to the casings of their doorways, which suggests that each set remains as created. The panel molding of the door to the east center room's closet suggests a c.-1889 attempt to replicate the moldings of the original doors; this is consonant with its doorway's casing, which incorporates two pieces of original, reused trim. The molding of the door to the northwest room's closet is rather nondescript, but more in keeping with a late 19th-century date than a mid 19th-century date. Its doorway's casing exhibits almost the same profile. Therefore, it seems that this closet -- once thought to date from c. 1850 -- was not installed until 1889.

The same c.-1889 panel molding is found on the door to the attic stair. Effort was made to get a reasonably good reproduction doorway casing here, though, and it is unclear as to why such a prosaic door-panel molding was used. There is a very slight possibility that the "reproduction" casing is actually original and reused, which could explain the discrepancy.

DOOR-PANEL MOLDINGS

All original doors
(1802-1804)



Second-floor north rooms'
doors (1810-1820)



Second-floor east center room,
door to northeast
room (c. 1850)



Second-floor east center room,
door to closet (c. 1889)

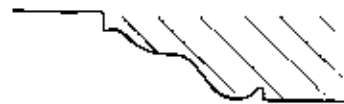

Second-floor center hall, door
to attic stair (c. 1889)
Second-floor northwest room,
door to closet (c. 1889)

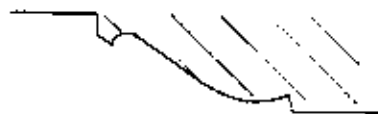

Muntins. There are three distinct original muntin profiles used at the Grange. The one found most frequently is the standard ovolo-and-fillet profile (A) — although it is less elongated than might be expected of a sophisticated Federal-style house. This profile is used for all of the double-hung windows on both floors. The muntins of the second-floor east-elevation windows are 1978-1979 copies of this original form.

The next most frequently found profile is a variation of the first form, in which the ovolo shape is reversed to create cavetti (B). The fillet here more closely resembles a bead. This profile is used for all of the sash of the triple-hung windows in the octagon rooms.

The last muntin type combines the ovolo and cavetto forms to produce an ogee shape topped by a fillet (C). This profile is found only upon the sash of the tripartite window in the second-floor front hall.

MUNTIN TYPE A: ovolo and fillet

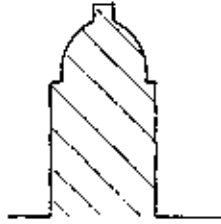

MUNTIN TYPE B: cavetto and bead

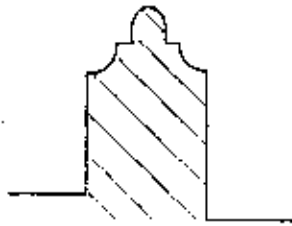

MUNTIN TYPE C: ogee and fillet

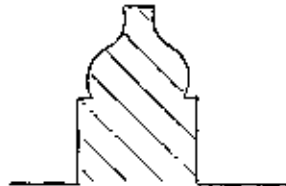

Shutter-Panel Moldings. There are three types of exterior shutters on the Grange today. The two types found on the double-hung windows — judging by their panel arrangement and hardware — date from 1802-1804. The first type features three solid, flush panels per leaf, with the top panel being much smaller than the other two, identical panels. The second type is similar, except that it substitutes a section of louvers for the top, solid panel. All of the solid panels are edged with a simple quirked bead.

The third type of shutter is found only on the triple-hung windows. It features three equal-size, recessed panels edged by a Grecian ovolo-type molding, and so is thought to date from c. 1845, when the Ward family moved into the Grange.

The fully louvered, south-elevation shutters of c. 1835 — none of which remain on the Grange — probably would not have had any panel moldings, not having had any panels.

The only interior shutters at the Grange are those of the front entrance enframingent. These are recorded in Appendix H, sheet 17.

SHUTTER-PANEL MOLDING TYPE A: quirked bead



SHUTTER-PANEL MOLDING TYPE B: Grecian ovolo

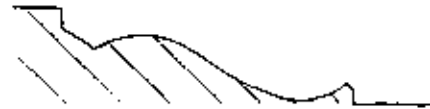

Appendix N

Hardware Analysis

Original Locks. Both imported and domestic locks were available on the New York market at the time the Grange was built. Considering Alexander Hamilton's personal interest in American manufacturing, it is not surprising that all but the front-door lock were made in the United States.

The front door lock (Ill. 119) is a large iron-case rim lock of British manufacture: it has the latch bolt positioned above the dead bolt, rather than under it, as was standard American practice. Despite the coat of paint beneath it, the lock appears to be original, based upon its construction. It has a night latch below the dead bolt. The dead bolt is double-notched, indicating that the key had to have been turned twice to fully advance the bolt. There are assembly marks (////) scratched on the inside of the case. The latch-bolt spring is of steel. The brass knobs are typical, probably original, and the only ones remaining at the Grange (Ill. 120).

Another large, iron-case rim lock is stored at Federal Hall (Ill. 121). This one is of American manufacture. A letter accompanying this lock asserts that it was removed from the Grange's front door. It seems more likely that this lock was taken from the Grange's missing rear door. This lock has lever tumblers that exhibit a variation of the lock principle invented by Robert Barron (1778), with the movement of the two tumblers here being regulated by the "fence" on the bolt that must pass through the gates of the two tumblers. There are brass wards on both sides of the case, and a brass key. The pins for attaching the back of the case are threaded, eliminating the need for separate screws.

The interior locks originally used on the first floor of the Grange and on doors to important second-floor rooms were steel-case mortise locks (Ill. 122). Doors to other rooms received rim locks. This application is logical: mortise locks, being invisible from both sides, would be applied in the most formal areas, where the appearance of both sides of the door was important. Rim locks would be applied to areas where appearance was less critical, or in places where one side of the door was hidden, such as a closet.

Thus, mortise locks originally were installed on the doors to the first-floor southwest room (the study); to the octagon rooms; to the first-floor northwest and northeast rooms; and to the second-floor center rooms' hall doors. Other areas where mortise locks probably would have been used would have been upon the door linking the original entry hall with the original stair hall, and upon the door between the second-floor center hall and the large, north room. The door to the present second-floor southwest room has a mortise lock, but it seems to have been brought here -- along with the door -- from another, more important location. It is thought that this location was the doorway from the original first-floor stair hall into the original southwest closet adjacent to it. Cast-iron rim locks were used everywhere else.

The doors still bearing original mortise locks are those that lead:

- from the present first-floor stair hall to the southeast room
- from the south apse to the west octagon room
- from the north apse to the west octagon room (Extra Door #2)
- from the first-floor north hall to the northeast room (Extra Door #1)
- from the second-floor front hall to the southwest room (moved here from the first floor in 1889)
- from the second-floor center hall to the west center room

The oldest remaining rim lock is found on the second-floor northeast room's hall door (Ill. 123). This doorway was not created until 1810-1820, so it would seem that this lock could not be original. However, traces of paint and the scars of a previous lock can be found under this one, and it was until recently mounted upside down. It appears that it was brought here from another location, then, and so it could be original. Even if it is only c. 1810-1820, it looks very much like the original rim locks must have. It therefore has been treated as if it was original.

All original mortise and rim locks are nearly identical in their construction. They all have enclosed cases with bolts at the top, and door latches at the bottom, of the case. The key locks are central, with a cam for the door handle, offset and in line with the keyhole. The bolts are advanced by the action of the key, the latches by the action of the door handle knob. In these early locks, the bolts are generally notched twice, indicating that the key must be turned twice to fully advance the bolt. The bolts and latch in the mortise locks are of steel; other parts are brass. Most of the interior parts of the rim locks are of brass. The mortise locks also have a night latch above the door latch. This latch was designed to be "thrown" by the twisting of a small ceramic peg located to the side of the keyhole. Interestingly, the doors at the Grange were not cut to allow the action of this latch, and several of the mortise locks removed for examination had only a remnant of what seemed to be a ceramic peg in this position. (The circular hole on the plate of the mortise locks above the night latch was designed to allow the insertion of a screw to hold the peg.) A spring on the inside of the case back assured a tight fit. Several of the mortise locks use a type of steel wool, packed in under the latch, apparently to provide smooth traction.

Later Locks. The reason that there are so few early rim locks left, is because extensive lock-changing took place in the mid-19th century, and again in the late 19th century. Four replacement iron-case rim locks seem to have been installed in the mid-19th century. These are those on the doors leading:

- from the second-floor front hall to the southeast room. Stamped with the name of Robert Newell, active 1834-1856. Mounted upside down now
- from the second-floor center hall to the east center room. Bears the names of Frederick Arens and Louis Hamel, active 1842-1853
- from the second-floor north hall to the northwest room

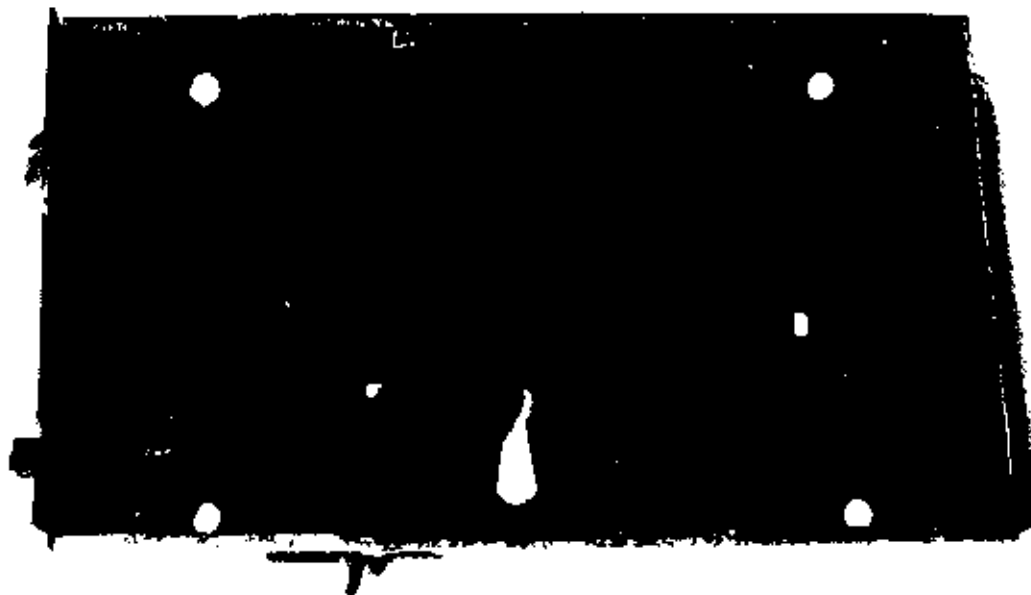

Illustration 119. The Grange: Mechanism of Front Door Lock (1977).



Illustration 120. The Grange: Brass Doorknobs of Front Door Lock (1977).



Illustration 121. The Grange: Mechanism of Lock Presumably from Original Rear Door (1977).

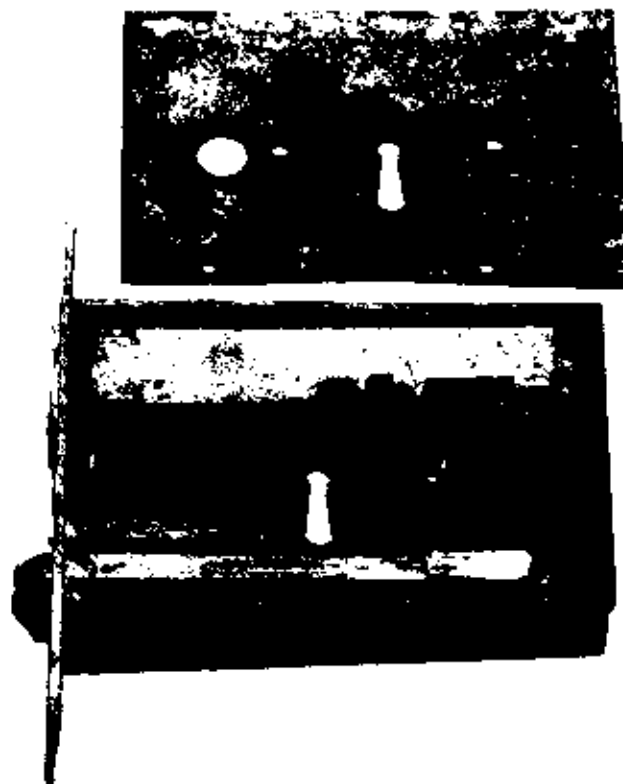

Illustration 122. The Grange: Mechanism of Early Mortise Lock, Door to First-Floor Southeast Room (1977).

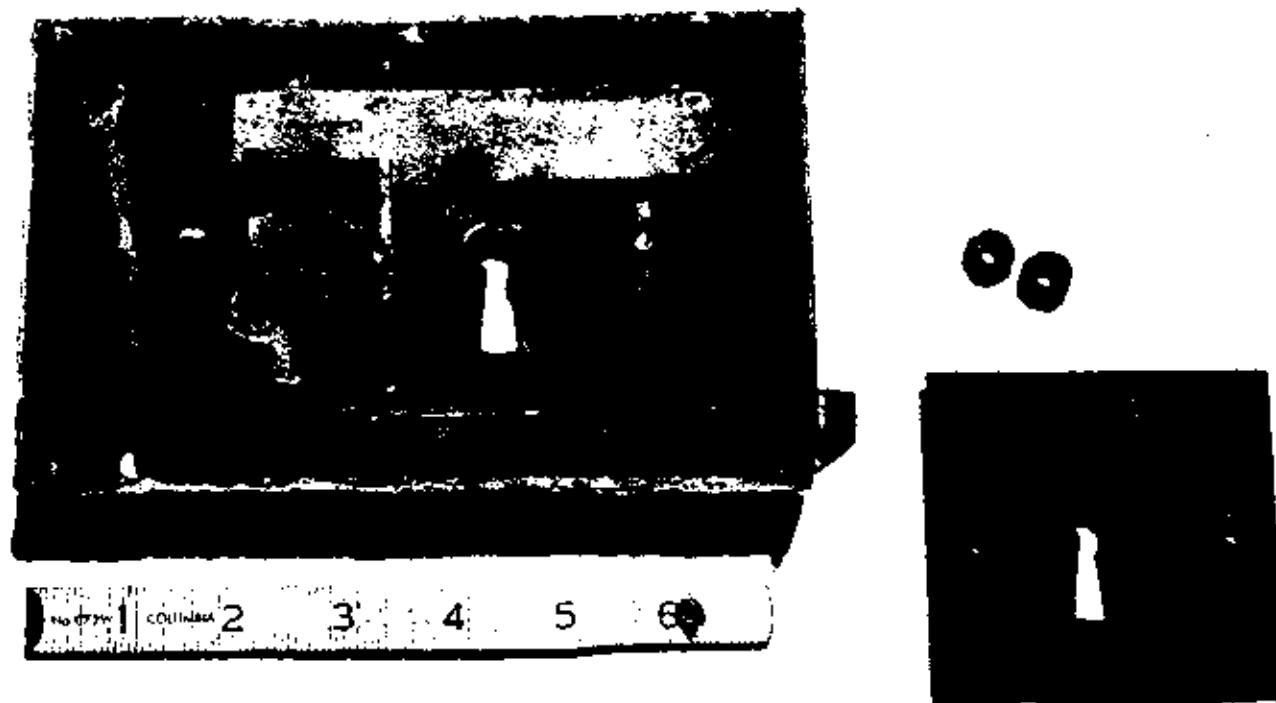

Illustration 123. The Grange: Mechanism of Early Rim Lock, Hall Door to Second-Floor Northeast Room (1977).

In addition, the doorway cut c. 1850 between the second-floor east center room and the northeast room received a door with an iron-case rim lock.

Quite a few locks were changed in the late 19th century, too, probably in 1889. Cast-iron mortise replacement locks were put on the doors that lead:

- from the south apse to the east octagon room (Extra Door #4)
- from the north apse to the east octagon room (Extra Door #3)
- from the first-floor north hall to the northwest room
- from the second-floor southwest room to the west center room
- from the second-floor north hall to the bathroom

Locks were also applied to those doors installed in 1889. New doors receiving cast-iron rim locks were those leading:

- from the second-floor center hall to the attic-stair compartment
- from the second-floor east center room to the closet inside the attic-stair compartment
- from the second-floor northwest room to the closet beside the fireplace

The reasons for the lock changes are not entirely clear. For example, most second-floor locks of 1802-1804 were replaced c. 1830-1860 with locks whose appearance and technical capabilities represented very little improvement. Too, the second-floor east center room received a rim lock at that time, whereas it originally had a more-elegant mortise lock. Some of this might constitute repair work, but certainly not all.

Doorknobs. Grange doorknobs also were replaced over the years. This was partially the result of the aforementioned lock changes, but aesthetics played a role, too. The original knobs — probably brass — were replaced with ones of marbled porcelain in the mid- to late 19th century. This undoubtedly occurred as part of the extensive replacement of locks during this period. These knobs are still extant throughout the second floor. Downstairs, however, these in turn were replaced early in this century with knobs of pressed glass. Since the locks did not change at this time, it seems that this represents an effort to update nothing but the appearance of the doors.

Shutter Hardware. The variety of shutters extant and seen in early photographs suggests three successive shutterings for the Grange, with today's appearance being the product of the first and third. (No shutters remain from the middle effort.) The hardware upon today's shutters is a mixture of original pieces and reproduction pieces from 1933 and 1978-1979. (See Architectural Data Section, Chapter III, Section I, "Hardware.")

The halved-pintle and strap-hinge combination (Ill. 124) appears to date from the first Grange shuttering. This shuttering, judging by the presence of handmade screws, occurred either at the time of construction or shortly afterward. Some of the later shutters — the c.-1845 solid-paneled shutters on the triple-hung windows, in particular — have this old hardware as well. In this instance, the hardware must have been saved and reused when the original shutters at these windows were removed.

Of the two types of shutterdogs present on the Grange, the older — and probably original — type seems to be the "propeller" with blades of unequal size (Ill. 124). This assumption is based upon this type's thin material, and upon its association with original, undisturbed shutters, mainly those on the upper west and lower east elevations. The date of the other type is unknown, possibly 1933.

The flat shutterbolt (Ill. 126) seems to be the original form, again based upon its relationship to original shutters. The barrel-bolt (Ill. 127) seems to have been used only upon the triple-hung windows' present shutters. Whether the barrel type was used on the windows' two earlier sets of shutters is not known. As for the other fasteners used to hold the shutters closed, the tab and pin arrangement (Ill. 128) is almost surely original, since it is found on original double hung-window shutters. The age of the notched strap and button combination (Ill. 129) on the triple-hung windows' shutters is less clear. Since the present hinges here are thought to be original, reused material, the straps and buttons may be original, as well.



Illustration 124. The Grange: Exterior Shutters, Pintle and Strap Hinge (1977).



Illustration 125. The Grange: Exterior Shutters, Shutterdog (1977).

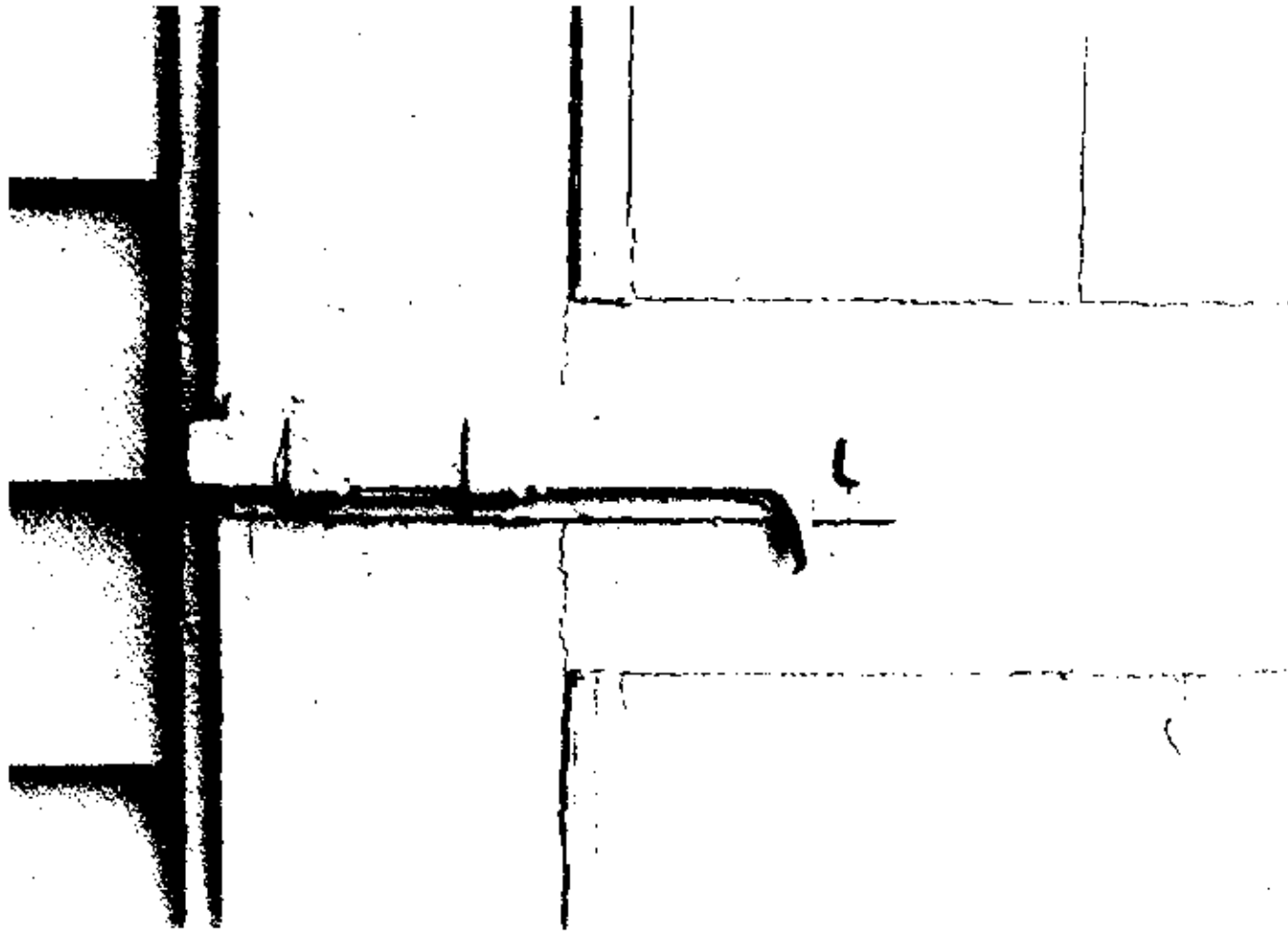

Illustration 126. The Grange: Exterior Shutters, Flat Shutterbolt (1977).

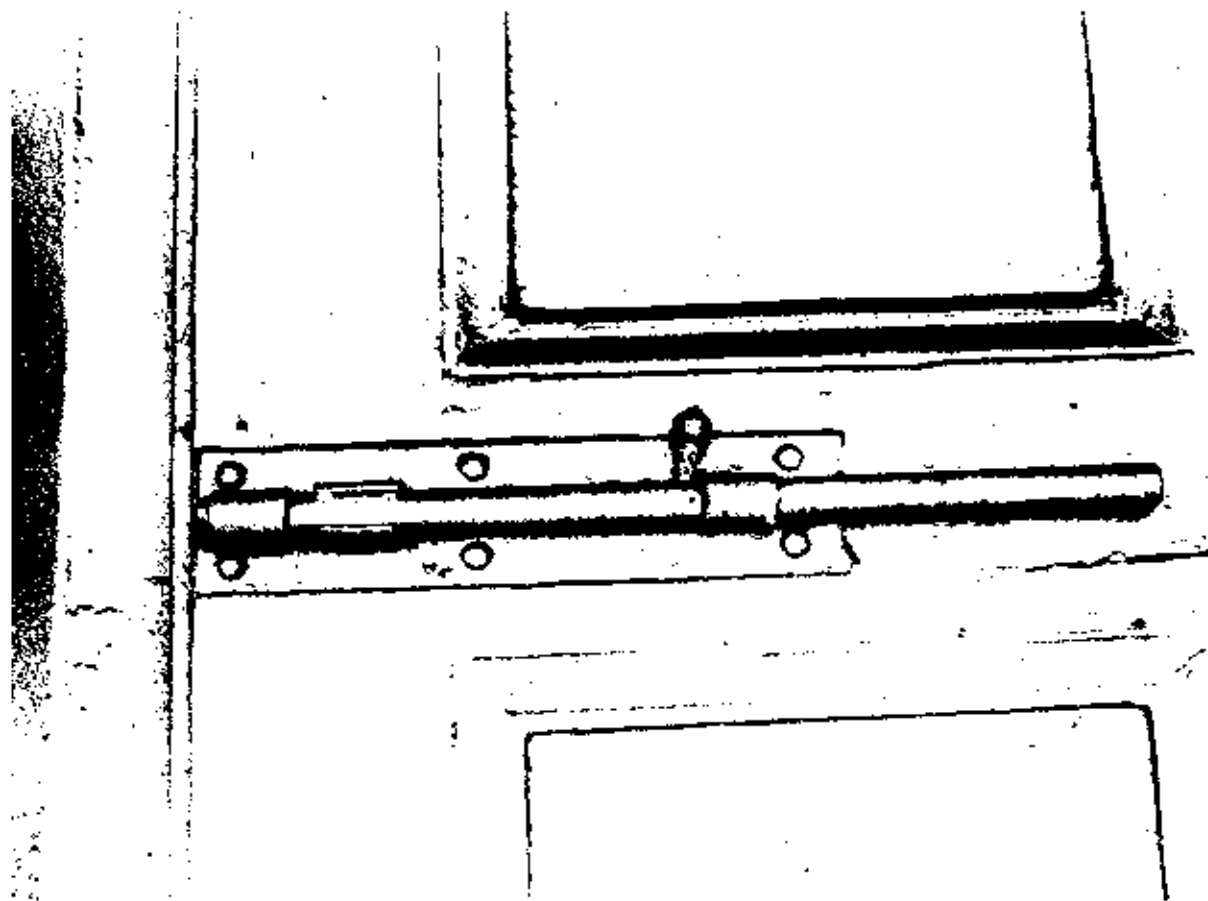
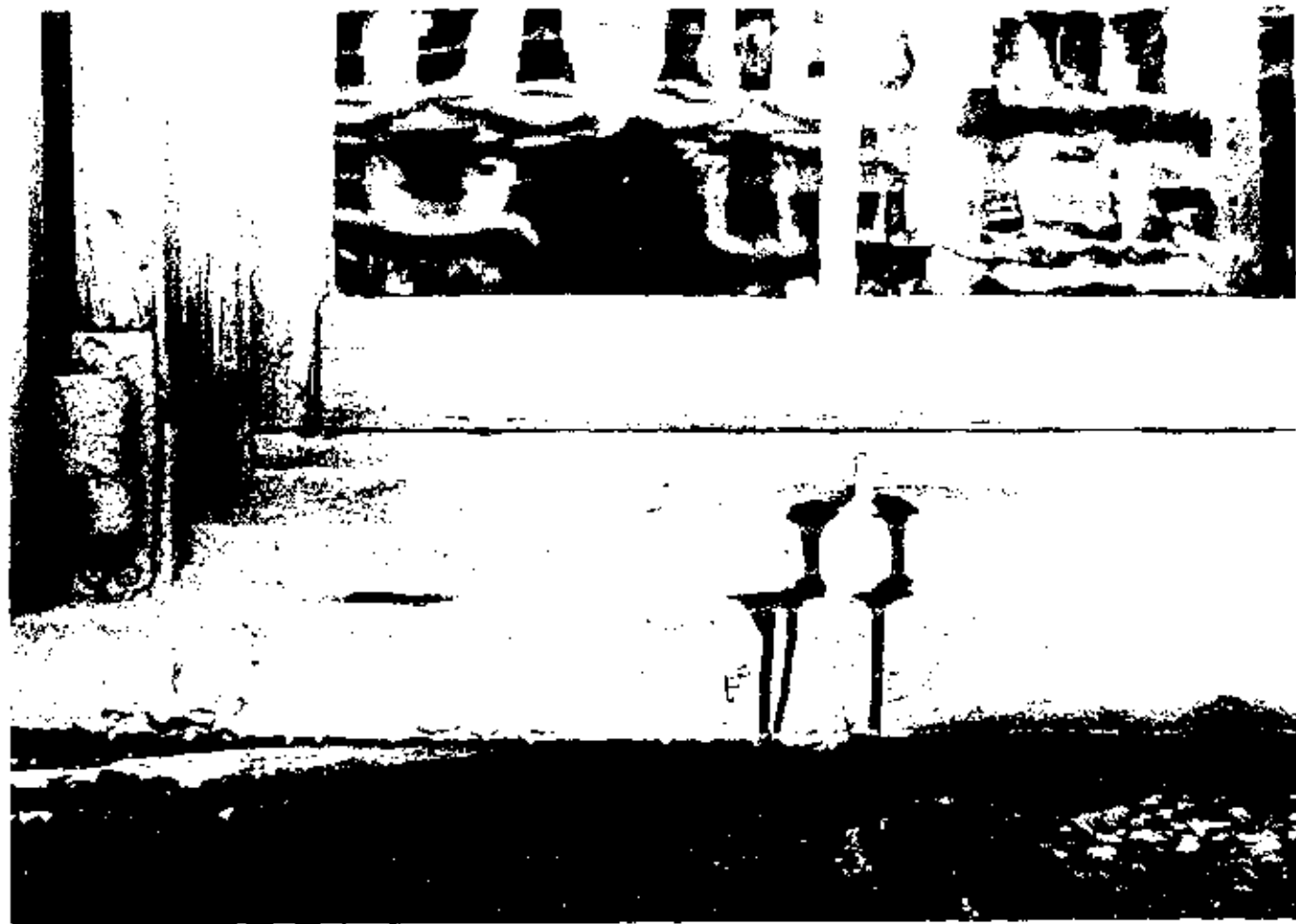

Illustration 127. The Grange: Exterior Shutters, Barrel Bolt (1977).



Illustration 128. The Grange: Exterior Shutters, Tab and Pin Fastener (1977).



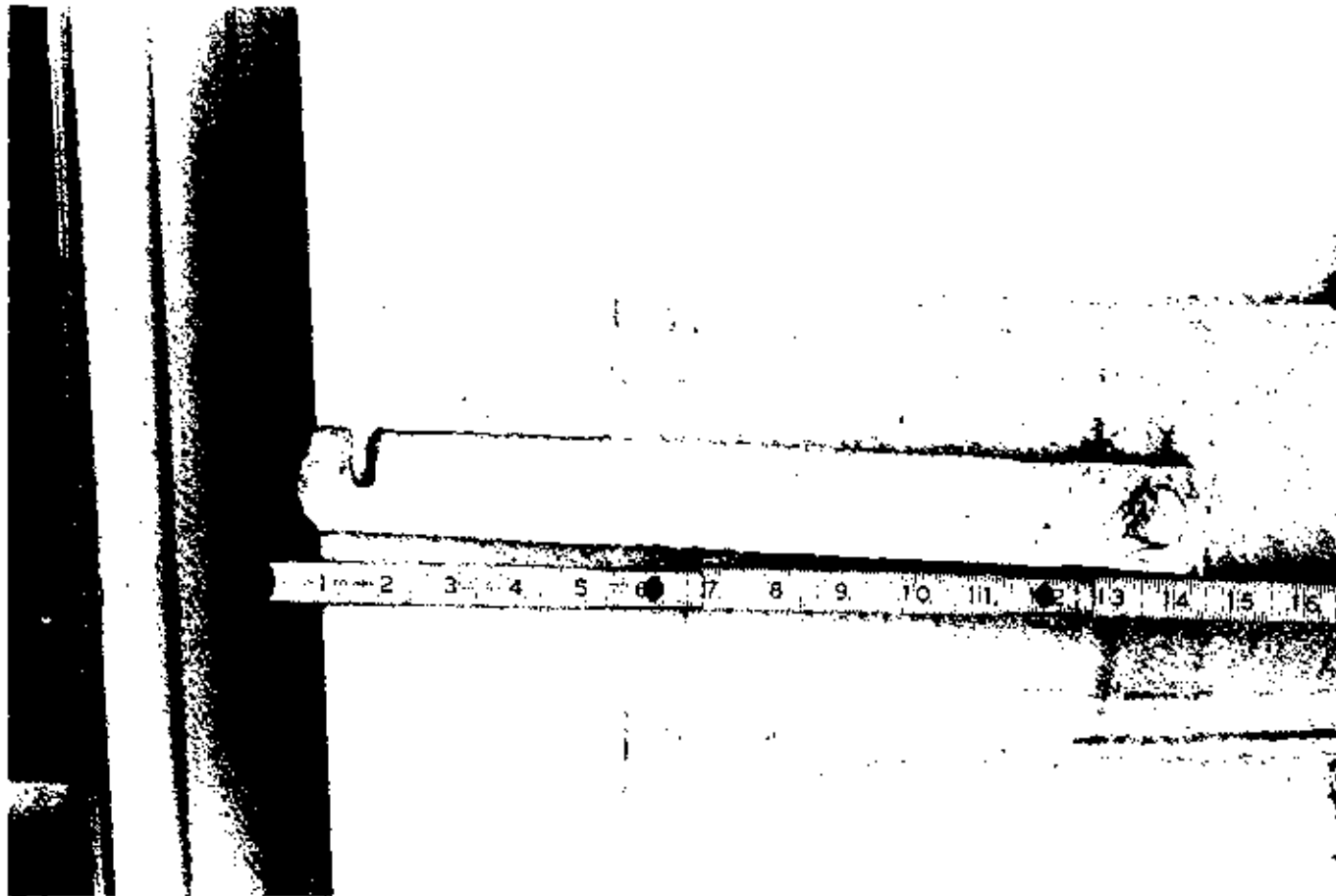
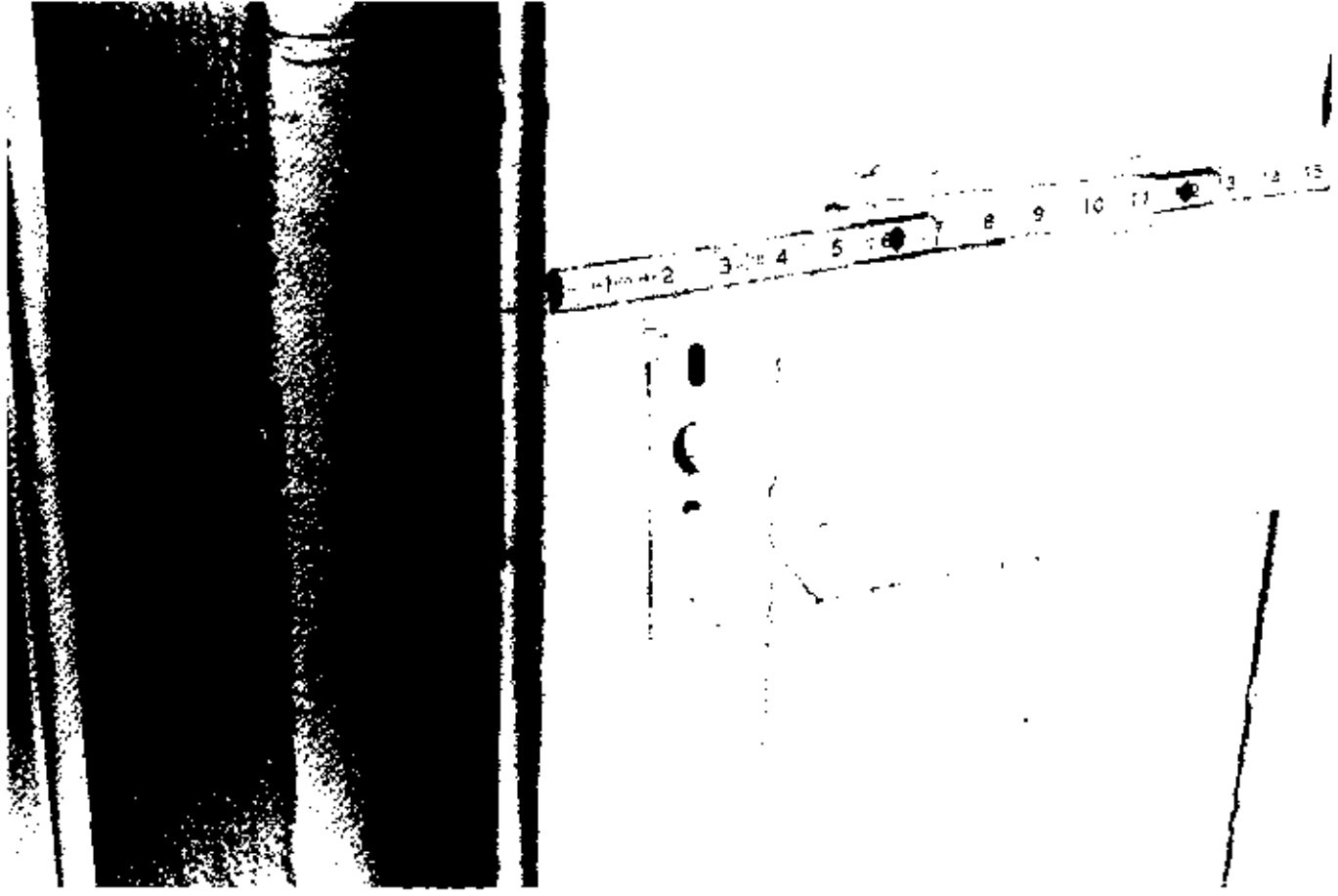

Illustration 129. The Grange: Exterior Shutters, Strap and Button Fastener (1977).



Appendix O

Nail Analysis

The Grange was built during a transitional period in American nailmaking. Around 1800, two types of nails generally were available: hand-wrought ones and machine-cut ones with handmade heads. Advertisements from New York City newspapers reflect the availability of both types during the years of the Grange construction. Typical of the ads was one from 1793 that advertised the sale of cut nails at a price "30-40% cheaper than wrought ones and warranted superior quality for lathing and short shingling." Another advertisement seven years later offered "cut nails and a general assortment of English and American wrought nails."

Most of the original nails used at the Grange are wrought nails. They were employed:

- a) in the construction of fireplaces (see heads of wrought nails where mantel has been removed from first-floor northeast room's fireplace)
- b) in the framing of door and window casings (see X-ray photographs included as illustrations)
- c) to fasten floorboards to joists
- d) to attach exterior sheathing, siding, and trim

The variety of nail types and sizes used on the floorboards gives some idea of the assortment of wrought nails used everywhere. Nails approximately three to three and one-quarter inches long with T-shaped heads were utilized for blind-nailing, which was done on the first floor; the narrow heads became invisible when sunk between the boards. Nails about three and one quarter- to three and five-eighths inches long, also with T-shaped heads, were used for place nailing, which was done on the second floor. Again, this style was chosen for its minimal visibility, but shanks had to be longer to penetrate the entire thickness of the floorboards. Nails approximately two and three-quarters inches long with the highly visible "rose" heads were employed to place-nail floorboards in the attic, where appearances did not matter. Small L-head wrought brads were used for finish work in door casings and other wooden trim.

Cut nails with handmade heads were employed in original Grange construction as well. Long ones were used to help attach the heavy plaster cornices in the two octagon rooms. Smaller cut nails, about two inches long, were used for lathing and shingling the roof. The presence of these handheaded cut nails on the bottom part of the main roof, and their absence on the upper part of the same roof, confirms the theory that an original flat deck was raised to the present configuration after 1815 or so, when the handheaded cut nails began to give way to early machine-headed cut nails. And the presence of handheaded cut nails in the partitions now dividing the second-floor north rooms of the Grange is one of the chief indications that the partitions were erected prior to 1825, when these cut nails disappeared altogether.

The Grange was relocated in 1889, and alterations made at that time were executed with late machine-headed cut nails and wire nails. The existence of these nails -- approximately three inches long in the floorboards of the current entry hall and second-floor southwest room, somewhat shorter in the casings of certain doors and windows -- has helped researchers determine the exact nature of the extensive 1889 alterations.

After 1900, almost all work done at the Grange was executed with modern wire nails.

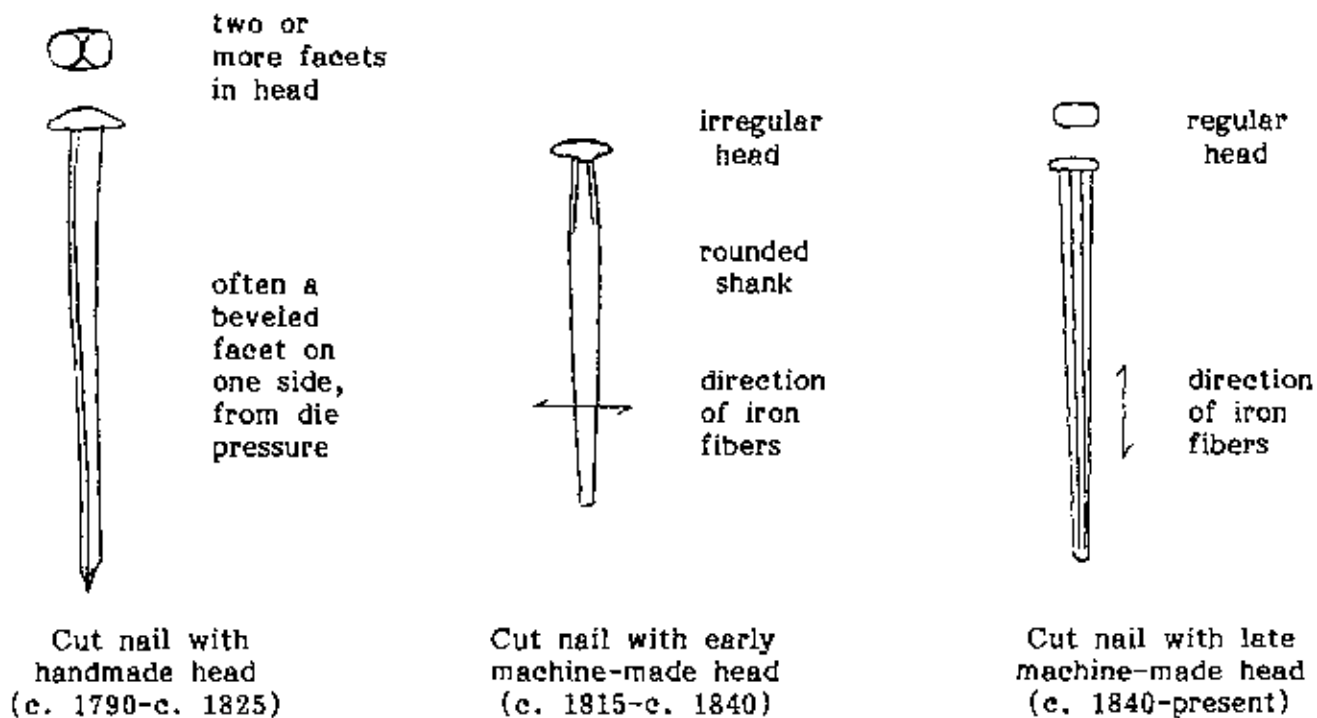
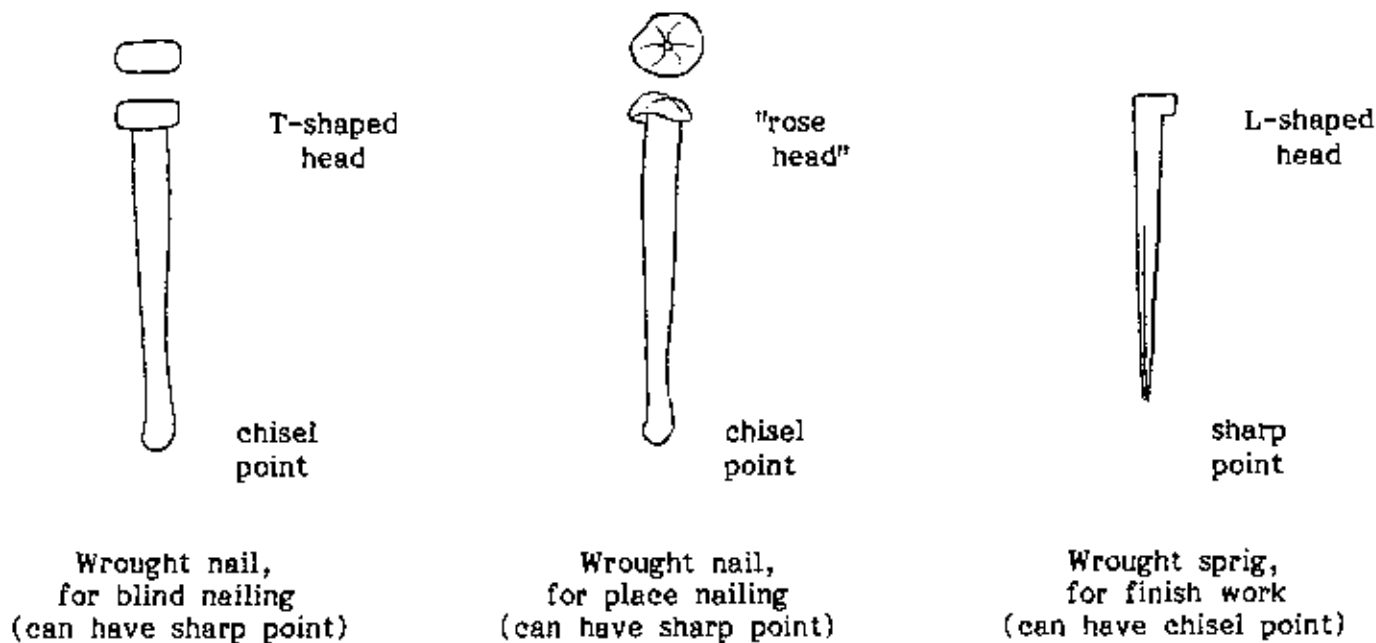

Illustration 130. Drawing of Nail Types.

Appendix P

MORTAR AND PLASTER ANALYSIS

Exterior

Eleven samples were taken from the working chimney stacks and foundation parget at Hamilton Grange in 1978-1979, prior to the Phase I stabilization work. The sources of the samples are as follows:

HAGR 01 M001	South-elevation foundation parget
M002	Northwest chimney, exterior, old-looking mortar
M003	South-elevation foundation parget
M004	Northeast chimney, inside attic
M005	East-elevation foundation
M006	Unknown
M007	Northwest chimney, exterior, new-looking mortar
M008	Northwest chimney, inside attic
M015	Northwest chimney, exterior
M016	Northeast chimney, exterior
M017	Both chimneys, inside attic

The samples were analyzed by staff members of the North Atlantic Historic Preservation Center, according to the methodology employed by that office. Samples M001-008 were tested by Sharon K. Ofenstein; samples M015-017 were done by Frank G. Matero.

Observations. Samples M001, M003 and M005 are obviously not from the historic period, because they are from 1889 foundation walls. Sample M007 seems to contain some type of cement, which would not have been used here as early as 1802-1804. Samples M004 and M008 have a high matrix-to-aggregate ratio (2:1). They also appear to contain clay, probably included as an extender. Their approximate formula is one part clay, one part sand, and two parts lime. The sand in these two samples consists of fine black and white grains, gray "dust," and tiny bits of deteriorated brick. Sample M002 contains little clay, but it is a high-lime mortar: about two and one-half parts lime to one part sand. The sand is very similar to that of samples M004 and M008, but seems to contain less deteriorated brick.

Samples M015 and M016 were taken from deep within the mortar joints approximately two inches behind the face of the bricks, so they should represent the earliest mortar. They do contain clay, like samples M004 and M008. However, their approximate composition is one part lime, one part clay, and three parts sand — less lime and more sand. Also, their sand samples are coarser and cleaner than those of samples M002, M004, and M008. Finally, the fines of samples M015 and M016 are not the same: those of the former are more brownish, while those of the latter are more grayish.

One problem with the chimney-mortar analysis stemmed from the fact that this mortar has been stained by pollutants within the smoke from the Grange's fireplaces and boilers. This stain impacted the mortar analysis in terms of the color of the filtrate; it caused it to exhibit a brownish tint.

Conclusions. The chimney mortar represented by samples M004 and M008 seems to be original, or at least very early. This is based upon its high lime and clay content; its lack of any cement; and its protected location inside the attic. The mortar seen in sample M002 is probably from the same period, despite its lack of clay and more exposed location. This is inferred from its high lime content; its lack of any cement; and its sand's similarity to that of samples M004 and M008. (The clay may have been left out of sample M002 because of its exposed location above the roofline, where additional strength would have been desirable.)

Samples M015 and M016 appear to be the products of somewhat later chimney rebuildings. They still would be rather early, because they contain clay. However, their coarser sand and varying fines colors set them apart from samples M002, M004 and M008. Sample M007 seems to be still later, judging by the probable presence of cement in it. And samples M001, M003, and M005 date from 1889 or after, because of the locations from which they came.

Repointing mortar for locations above the roof should resemble that seen in sample M002: one part sand to two and one-half parts lime. If the inclusion of cement is desired, a mixture of one part cement (white Medusa), four parts lime, and two parts sand could be used. Repointing mortar for locations below the roof should consist of the original mix of one part clay, two parts lime, and one part sand.

Future foundation pargeeting might use a mixture of one and one-half parts cement, one and one-half parts lime, and one part sand.

In both cases, the color of the mixtures may have to be adjusted, to approximate the tint produced by impurities in the early lime. This would be accomplished best by using a sand that exhibits the desired color. However, even though the original sand's color would thus not be matched, its grain size should be.

Interior

Six plaster samples (HAGR 01 M009-14) were taken in March 1980 and analyzed at the Preservation Center by Barbara E. Pearson. They were taken from the following locations:

- M009 1st floor ceiling, west bay, later overcoat
- M010 1st floor, original ceiling, west bay, east of main crack
- M011 1st floor, original ceiling, west bay, west of main crack
- M012 2nd floor, wall, northwest window, split lath
- M013 Basement, ceiling, east center room, split lath
- M014 Basement, interior wall, hall at bottom of stairs, sawn lath

In most cases, the middle scratch coat of the plaster samples was isolated for analysis. An insufficient amount of sample was available to isolate this layer in sample M009, so analysis was done on the skim coat.

In addition, the mortar of the original brick nogging (M018) and the brown plaster fireproofing laid beneath Grange floorboards (M019) were examined.

Observations. Plaster samples M010-M012 were observed to have both similar and dissimilar characteristics. The sand types are similar, and contain primarily clear quartz in addition to a characteristic red aggregate that gives the sand a pink tint. The size of the aggregate varies with each sample, however, M010 having the finest sand, M012 the next finest, and M011 the largest aggregates and most poorly sorted composition. The fines parts/volume of all three samples varies from 12-14. The fines color of M011 and M012 is a light brown, while that of M010 is red-brown. Red and light-color hair binder was observed in all three samples. Sand/lime ratios varied, M010 being approximately 9:5, M011 7:9, and M012 6:11.

Samples M013 and M014, from the basement, differed both from each other and from samples M010-M012. Sample M013 was observed to have an extremely fine brown-beige sand and high parts/volume of fines (32). The fines are a yellow-brown color, and contain a fiber — rather than a hair — binder. The approximate sand/lime ratio of this sample is 3:11. Sample M014, on the other hand, has a fines parts/volume of only 2, and contains both a hair and fiber binder. The sand of sample M014 is a coarse aggregate consisting primarily of clear and white quartz, in addition to an amber-color aggregate. The approximate sand/lime ratio of this sample is 10:3.

The skim coat of plaster sample M009 has a high parts/volume of both fines and lime, fines being 44 and lime 75. The fines are an off-white color. The amount of sand obtained was insignificant.

The mortar of the brick nogging (M018), tested by the Community Services Collaborative of Boulder, Colo., showed a composition of about one part clay, one part lime, and one and one-half to two parts sand.

The brown plaster fireproofing (M019) was examined only visually by NPS park personnel, but it is definitely not the same as either the nogging mortar or the brown coats of the wall plaster. The fireproofing is full of dirt and extremely friable, and useful for no other purposes.

Conclusions. Most plaster samples identified as being original plaster (laid on split lath) were observed to have a higher parts/volume of lime than sand. These include M011, 012, and 013. Of these samples, M011 and M012 are very similar to each other and appear to be contemporary, having similar parts/volume of fines, sand, and lime; and similar fines colors and sand types. Sample M013, on the other hand, appears to have been a different mix, having slightly more yellow fines, a fiber binder rather than hair, and a different sand type.

Mortar sample M010 also was identified as being original plaster, because of its application on split lath. Its sand and hair binder types are similar to those of samples M011 and 012. However, it differed from these samples in having a lower lime ratio, and its fines were distinctly more reddish in color. In conclusion, this sample may be contemporary with M011 and M012, and the differences attributable to the peculiarities of a particular plaster batch. This plaster may also have been applied at a different time.

The nogging mortar is definitely thought to be original, because of its location. The fact that it contains clay adds weight to the idea that clay was used in original mortar for other protected areas as well (samples M004 and M008). The fact that it contains less lime and more sand than these other samples is probably due to its nonstructural, totally enclosed location. The fireproofing sample M019 is deemed original as well, again because of its location and usage. Based on the other early samples, it probably contains a great deal of clay.

Plaster sample M014 was found on sawn lath, and is therefore most likely a later plaster than samples M010-M013. The plaster differed by having few fines, a high sand/lime ratio (more sand than lime), and a coarse sand mix that contained mica. The binder also differed by being composed of both hair and fiber.

Since only the skim coat of sample M009 was analyzed, it is not possible to compare analysis results with the other plaster samples. It is possible to conclude, however, that this skim coat is composed primarily of lime, an insignificant amount only of fine, light-color sand having been obtained.

Appendix Q

Other Sources Investigated

Hamilton Period

Hamilton cash books. These provide more figures of the total cost of the Grange, but are not specific enough to be of use for the present study.

Schuyler family papers. Schuyler papers on file in the manuscript room of the New York Public Library contain references to a house built in 1798, which -- considering the closeness of Hamilton and his father-in-law -- might be expected to provide some clues to the structure and finish of the Grange. These documents describe the location of the house as being on Court Street near the ferry in Albany, and include payments for constructing sliding sash, laying floors, constructing and painting bannisters, and painting "curting [curtain] frames." Unfortunately, this building is no longer standing in Albany.

Hamilton Estate Period

Advertisements of estate in New York City newspapers. These advertisements, published in the winter of 1804-1805, are interesting but too general to be of much use. One, from the Mercury Advertiser in December of 1805, describes the Grange as "Hamilton's Country Seat," and as being "spacious, new, and furnished in the handsome stile of modern architecture." The other, from January 1806, is similar. Both advertisements also describe the grounds and location of the house.

Legal documents. None of the documents pertaining to the arrangements made by the trustees under Hamilton's will or by the consortium of his friends are applicable to this project, although both sets are on file at the Bank of New York.

Period of Use as Ward Family's Summer Home (1845-1876)

Diary entries of Ward family. The diaries of John Ward, Jr., a member of the Ward family that occupied the Grange during the summer, are held by the New-York Historical Society. While the young law student made reference in his diaries to activities he and friends engaged in while visiting at the Grange, the contents of the diaries contain no descriptions of the Grange itself. No other diaries of the immediate Ward family are known.

Period of Ownership by William DeForest (1879-c. 1888)

The article on the Grange written by George Townsend in 1886 reports that then-owner William DeForest had removed at least one and possibly three mantels from the Grange for installation in his townhouse at 12 W. 57th Street. A reprint of a book originally published in 1883, Artistic Houses — Being a Series of Interior Views of a Number of the Most Beautiful and Celebrated Homes in the United States (Vol. I), contains several photographs of this townhouse. Shots of the main bedroom, hall, library, dining room and parlor show heavy, ornately carved Victorian mantels only. Obviously the Grange mantels had not been moved to this house prior to 1883, but they could have been moved 1883-1886. It seems unlikely that any of the mantels were installed in William DeForest, Jr.'s house at 821 Madison Avenue; the mantels known to be in that house before it was demolished were less ornate than those in the second-floor rooms of the Grange.

Period of Ownership by St. Luke's Church (1888-1924)

Business records -- vouchers, invoices, receipts, credit entries, etc. -- of St. Luke's Church for the period that the church held title to the Grange were not found by Whidden and may have been destroyed.

Period of Ownership by the American Scenic and Historic Preservation Society (1924-1962)

Records of the society. Copies of the minutes of the monthly business meetings and annual reports of the society are on file at Federal Hall, but volumes from the years 1943-1951 are missing. The records of the society for these years might provide further documentation on the upkeep of the Grange.

The minutes of a meeting of January 4, 1926, report that Charles Platt, AIA, had been asked to prepare a "Restoration Plan" for the Grange. Such a plan, if actually executed, might provide evidence of the configuration and condition of the house at the time, as well as information about the proposed restoration. No evidence has been found that such a plan ever was completed. Avery Architectural Library at Columbia University contains a collection of drawings by Platt donated by his sons, but nothing is listed pertaining to the Grange.

Minutes of the meeting of May 15, 1939, report that Harvey Stevenson, AIA -- "an authority on pigments used during the Federalist period of American architecture" -- was retained, presumably to advise the society on colors appropriate for the Grange. No further information about Stevenson's advice or expertise has been found.

Minutes of the meeting of November 27, 1933, report a proposal by the Washington Heights chapter of the DAR that they furnish the second-floor west center room as a "colonial living room" to use for their meetings. A request for pertinent information or photographs from the chapter yielded nothing.



1000

1000

1000

1000

1000

1000

1000

1000

1000

1000

1000

1000

1000

1000

1000

1000

1000

1000

1000

1000

1000

1000

1000

1000

1000

1000

1000

1000

1000

1000

1000

1000

